



La solution à votre mesure



/ Test & Measure

POWER SUPPLIES CATALOG



World-Class Quality and Performance

Affordable Price

A Wide Range of Selections

Originally known and founded in 1975 as Good Will Instrument, GW Instek is the first professional manufacturer in Taiwan specializing in electrical test and measurement instruments. GW Instek began as a manufacturer of power supplies and quickly expanded into developing high precision electronic test and measurement instruments. After 48 years in the test and measurement industry, GW Instek has grown to become one of the most recognized manufacturers of instruments in the world. Today, GW Instek has more than 300 items ranging from oscilloscopes, spectrum analyzers, signal sources, DC power supplies, AC power sources, digital meters, LCR meters, other specific application meters to video surveillance systems.

Think of the word "innovation" and it's easy to think of R&D, new inventions, faster processing and groundbreaking technologies. At GW Instek, we focus on another type of innovation that is based on flexibility, manageability and efficient performance in real-world test applications. We call this "customer-focused" innovation and we strongly believe in it. By listening to our customers around the world, we are able to anticipate their needs and respond quickly to emerging trends. So when one of our customers introduces an exciting new technology, GW Instek is ready to test it.

Whether our customers are designing products with the ability to change people's lives, educating and training the engineers of tomorrow, or discovering new technologies that solve complex problems, GW Instek can be trusted to perform reliably and accurately in even the most demanding test environments. How can we be sure? We have the numbers to back it up. Actually, we have just one : 40. That's the number of in-house quality and performance verification tests each GW Instek product must pass before it leaves our facilities. This thorough process starts with environmental, safety and durability testing in the product design phase, through to burn-in and shipping tests ahead of final inspection and packing. Furthermore, our two manufacturing facilities in Taiwan and China all adhere to ISO quality and environmental management standards, as well as European CE safety regulations. That's why GW Instek products can be trusted to test.

At GW Instek, quality is reflected not in higher cost, but in greater value. We pride ourselves on the quality, reliability and affordability of our test and measurement instruments. With each of our products often in use for decades, it's not hard to understand the importance of measuring a product's value not by price, but by lifetime cost. This importance is deep-rooted to us; we have consistently produced products with some of the industry's lowest total cost per ownership. Reducing the total cost per ownership of our products allows us to provide exceptional value, reliability and performance with leading service and support over the lifetime of a product. That's why year after year, GW Instek can be trusted to perform reliably.

The industries we serve are as diverse as they are specialized. Our experience and expertise allow us to deliver high-performance test solutions that address the unique requirements of each client. GW Instek provides customized solutions that are backed by reliable products, comprehensive after-sales support, warranty, calibration services, and one of the industry's lowest Total Cost per Ownership.

SINCE
1975



48 Years of Reputation
& Trust

We take prides in creating more than 48 years of satisfied customer experiences throughout the world. Today, GW Instek is considered the most Reliable Brand for professional measurement instruments with supreme quality and the **lowest TCO - Total Cost per Ownership**.

We invite you to be part of GW Instek success story and help perpetuate this value.

DURABLE



Uncompromised
Durability

With an overriding commitment to provide highly durable products, GW Instek is your most **Reliable choice** when it comes to selecting the best measurement instruments with the **lowest TCO - Total Cost per Ownership**. Highly durable products mean long product lifetime capable of reducing operation & maintenance costs. This is definitely what you need to consider before investing.

TRUST &
PROMISE



Your Most Trustworthy
Partner

Being your most trustworthy and **Reliable Partner**, GW Instek promises to proactively provide insightful business solutions and products with the **lowest TCO – Total Cost per Ownership**, assisting your business to thrive in the highly competitive world. From feasibility evaluation, product selection, solution adaptation to timely after-sales service, we are dedicated to serving each individual customer and making your professional life easier than ever.

Milestones

- 
- 1975** Good Will Instrument Co., Ltd was established as a Power Supply manufacturer.
- 1983** The Kaohsiung branch was established.
- 1985** The Taichung branch was established.
- 1989** Good Will Southeast Asia (Malaysia) was established.
- 1991** Instek America Corp. was established.
- 1993** Taiwan headquarters was ISO-9002 certified.
Granted the National Small and Medium Enterprise Award.
Granted the Industrial Technology Advancement Award of Distinction.
- 1996** Good Will Southeast Asia (Malaysia) was ISO-9002 certified.
- 1998** Taiwan headquarters was ISO-9001 certified.
- 1999** Taiwan headquarters was ISO-14001 Environmental Management certified.
Good Will Instrument Co., Ltd. delivered Initial Public Offer on Taiwan's Over-The-Counter Security Exchange (OTC).
- 2000** The CNLA Electricity Calibration Laboratory certification was granted.
Good Will Instrument was went public on the Taiwan Stock Exchange.
- 2001** Good Will Instrument Suzhou was established.
- 2002** Taiwan headquarters was ISO-9001 : 2000 certified.
- 2003** Suzhou subsidiary was ISO-9001 : 2000 certified.
- 2004** Instek Electronics Shanghai was established.
- 2005** Global operational headquarters was established in Taiwan.
The brand new CIS (Corporate Identity System) was introduced.
- 2006** Instek Japan Corporation was established.
- 2007** Good Will Instrument Korea was established.
- 2009** The Group Quality Award of Business Excellence Performance Model from the Chinese Society for Quality was granted.
- 2010** Marketing office was set up in India.
- 2011** GW Instek won Taiwan Excellence Award for GDS-1000-U Series, AFG-3000 Series, PEL-2000 Series and GDM-8261.
- 2012** GW Instek won Technology Innovation Award for GDS-3000 Series and GSP-930.
Acquired Japan TEXIO technology corporation.
- 2013** Instek Digital was merged to become a member of GW Instek business group.
GW Instek cooperated with Hitachi and EMIC to establish GW Alliance in Suzhou, China.
GW Instek won Technology Innovation Award for PPH-1503 and AFG-2225.
- 2014** GW Instek won Technology Innovation Award (Gold) for GDS-300 full touch screen oscilloscope.
European subsidiary was established in the Netherlands.
- 2015** GW Instek won Taiwan Excellence Award for GDS-300/200 Series and PEL-3000 Series.
- 2016** GW Instek won Taiwan Excellence Award for GDS-2000E Series and GSP-9330.
- 2017** GW Instek won Taiwan Excellence Award for C-1100 and GPM-8213.
- 2018** GW Instek won Taiwan Excellence Award for C-1200 and GDM-906X Series.
- 2019** GW Instek INDIA LLP was established.
GW Instek won Taiwan Excellence Award for GPT-12000 Series and SKTS-5000.
- 2020** GW Instek won Taiwan Excellence Award for C-3200 and GPM-8310.
- 2021** GW Instek won Taiwan Excellence Award for GDS-3000A Series, PPX-Series, GPP-3060/6030 and GSM-20H10.



Global Network



Suzhou Plant



Headquarters & Plant



Europe Subsidiary

Malaysia Subsidiary

India Subsidiary

China Subsidiary

Japan Subsidiary

Korea Subsidiary

U.S.A. Subsidiary



Comprehensive Electronic Measurement Solutions

Becoming the highest customer value TMI products and services provider in the global market is the vision of GW Instek and this vision, in the meantime, has always been the managerial objective ever since the establishment of the company. Over the span of 44 years' continuous refinement and progression, GW Instek began as a manufacturer of the earliest models of analog power supplies and has rapidly expanded to provide users of nowadays with more than 300 products consisting of 500 MHz Digital Oscilloscope, High-Power D.C. Power Supplies, High-Power D.C. Electronic Loads, 3 GHz Spectrum Analyzer, 80 MHz /25 MHz Arbitrary Waveform Generator, Programmable D.C. Power Supplies, A.C.(D.C.) Power Source, 6 1/2 Digit Dual Measurement Multi-Meter, 10 MHz High Frequency LCR Meter, and All-in-one electronic Safety Testers, etc. so as to not only fully satisfy users' demands in the process of product development, verification, production, test and quality assurance, but also meet comprehensive and complete equipment requirements for a wide extent of tests, including military industry and scientific research.

Manufacturers of various industrial electronic and consumer electronic products are seeking ways to reduce production costs down in order to keep up with the market competitiveness while facing the dramatic changes of the global electronic industry. The design of the new generation programmable switching power supply satisfies the recharging test applications for high power batteries. The built-in Sink Current Circuit not only effectively expedites the voltage fall time during output off mode, but also prevents reverse voltage from happening so as to effectively protect the power supply. Reverse voltage occurs when external voltage is higher than the internal voltage of the power supply once the external unit is fully charged. The new generation Programmable Switching D.C. Power Supply adopts Interleaved PFC (Power Factor Correction Circuit) and DC/DC module circuit to effectively reduce high frequency ripples during output on and to meet the requirements of low ripple applications.

In recent years, we have successfully constructed power measurement functions on Digital Storage Oscilloscopes. Via the combination of Power Management App and internal measurement hardware module, we have simplified the required power measurement equipment. With respect to AC/DC Power Source products, we have met the international regulation (Energy Star) for low standby mode power consumption measurement requirements. To meet the requirements of all-in-one equipment, we have combined A.C. power source with power meter measurement functions. All-in-one equipment provides convenience for measurement and system integration, and most importantly, it strengthens the market competitiveness and dramatically enhances functionality. In the future, we will devote our efforts to strengthening single instrument's performance, including A. user interface; B. measurement items; C. measurement accuracy; and D. measurement speed to meet the recent industrial requirements from power supply manufacturing, automotive electronics, and green energy industry.

More than a simple instrument provider, GW Instek, with scores of practically applied experiences in instruments, is now offering this specific catalog for power supplies to betterly provide users with a conceptually systematic combination, further assisting our customers achieving the purposes of both products applications and measurements.

Uncompromised Durability
with Highest Quality Standard



Editing and Synthesis of Power Supply Output Waveform

In the development and verification process of electronic products, signal generators are often utilized to generate test signals or simulate signals for testing and specification/ function verification of the designed electronic circuit. Common test signals include Sine, Square, Triangle, Ramp, Pulse, Noise, Burst waveform and communications modulation waveform etc. Signal generators provide a variety of test waveforms that can meet a variety of applications, however, signal generators generally only provide 10Vp-p signal output, which cannot meet the requirement of the test signals for high-voltage outputs. Using a signal generator with a GW Instek ASR series power source can provide high-voltage output test signals.

Select AC power output mode (AC-INT Mode) or AC/DC power output mode (AC+DC-INT Mode) of ASR-Series to set AC power output or AC&DC power output; select External AC signal source mode(AC-EXT Mode) or External AC/DC signal source mode (AC+DC-EXT Mode) to use the ASR series as an amplifier, which can directly amplify and output external input signals by the ASR series; select External AC signal superimposition mode (AC-ADD Mode) or External AC/DC signal superimposition mode (AC+DC-ADD Mode) to superimpose and output the external input signals and the voltage signals set by the ASR series. Signal generator+ASR-3000 provides a maximum signal output of 400Vrms/±570Vdc/999.9Hz, and signal generator+ASR-2000 provides a maximum signal output of 350Vrms/±500Vdc/999.9Hz.

In addition, the editing and synthesis of power waveforms can also be realized via the PC Software provided by the ASR series. PC Software's built-in Arbitrary Waveform Function (ARB) editing function can directly save the edited test waveforms to a USB flash drive and upload it to the ASR series or directly transmit them to the ASR series through a communications interface (USB, LAN, RS-232 or GPIB) for the output to the DUT. The ARB editing screen has a canvas with a horizontal axis of 4096 points (0~4095) and a vertical axis of 16bits resolution (-32767 ~ +32767) for users to edit user-defined arbitrary waveforms. Editing methods include 1) Draw hand-drawn pen mode; 2) Line straight line mode; 3) Insert function mode Sine, Square, Triangle, Exponential Rise, Exponential Fall, Noise, DC and Harmonic Synthesizer; 4) Oscilloscope directly imports waveforms(GDS-3000 only); 5) Mathematical synthesis waveform modes: Add, Subtract, Multiply. The examples in the figures below are i). Sine waveform mathematically synthesized 1/4 amplitude & 5 times frequency Sine waveform; ii) Sinc waveform starting from 90 degrees and lasting 1024 points to connect with two cycles of hand-drawn waveforms; connect the Triangle waveform starting from 0 degree and last for 1024 points; and finally connect the Noise waveform.

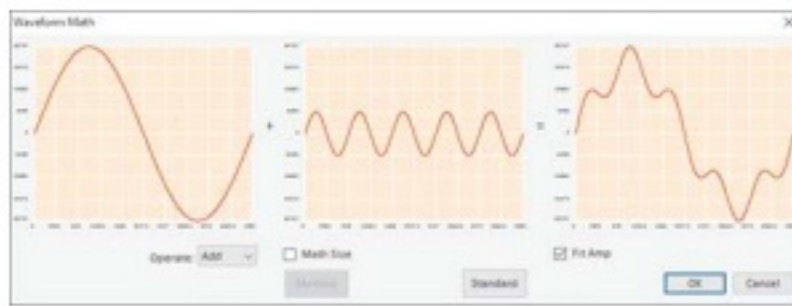

Sine+(1/4 Amplitude& 5 Times freq.) Sine Waveform

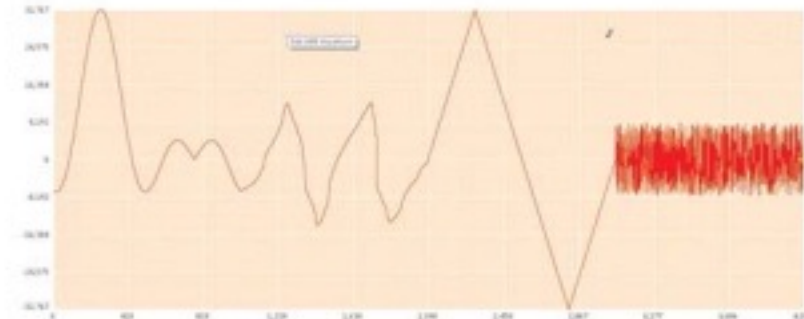

Sinc+Draw+Triangle+Noise Waveform

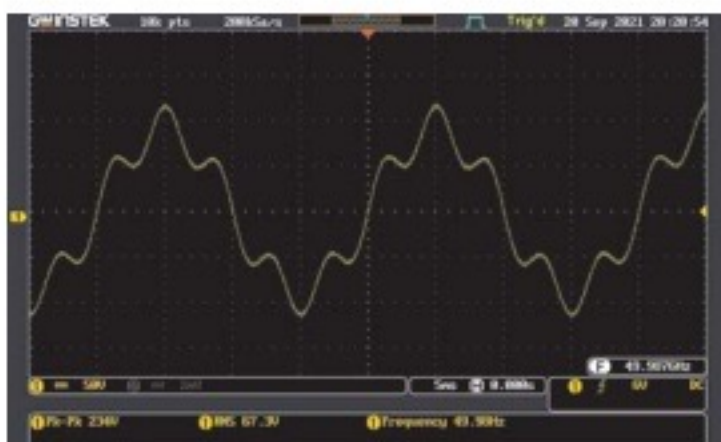

Shown on Oscilloscope

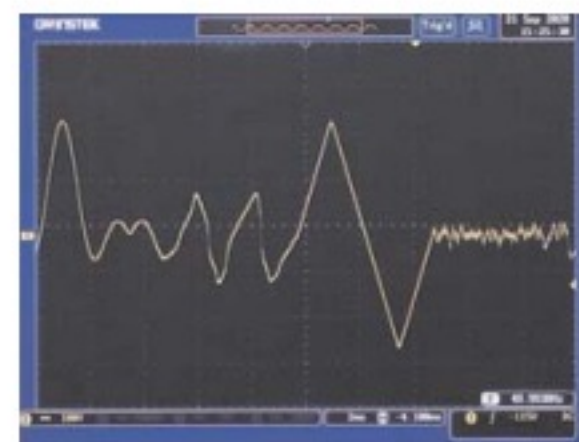

Shown on Oscilloscope

Single-phase AC Power Source and Applications of Three-phase System

AC power is a power supply whose voltage amplitude and current direction change periodically. AC power is often used as a source of household power and industrial power. AC power is mainly divided into single-phase and three-phase power supplies. Single-phase power includes a live wire and a neutral wire. In most cases, household power and general commercial power are provided by single-phase power, since single-phase power has the advantages of simple wiring and low design cost. Three-phase power includes three live wires and a neutral wire. The three live wires have same frequency, same voltage amplitude and the phase difference of 120 degrees. The advantages of the three-phase power are small power loss, better power output efficiency, stable current, and operating under a larger power load, therefore, three-phase power is often utilized in industries, power grids, and places with large power load requirements.

GW Instek ASR-2000/3000 Series are a single-phase AC+DC Power Source. ASR-3000 Series provides a maximum power output of 4kVA/400Vrms/±570Vdc, which not only outputs AC sine wave, square wave, triangle wave, but also allows users to edit 16 sets of arbitrary waveforms. Furthermore, the powerful ASR-2000/3000 Series AC power source can measure Vrms, Vavg, Vpeak, Irms, Iavg, Ipeak, IpkH, P, S, Q, PF, CF, Voltage Harmonic and Current Harmonic, and set the start /stop phase of the output waveform to generate sequential AC and DC power output.

ASR-2000/3000 Series have an option of ASR-002 three-phase power controller to achieve voltage multiplication and meet the output requirements of 1P3W, 3P3W, and 3P4W power output. Users use a computer to communicate with ASR-002 and ASR-002 synchronously controls signals so as to control the output amplitude, frequency and phase angle of three ASR-2000/3000 Series to provide a three-phase power output. ASR-2000/3000+ASR-002 is a practical single-phase three-phase AC output solution.

*Functions of ASR-Series are limited when ASR-Series applied to ASR-002. Please refer to ASR-2000/3000 for detailed information.

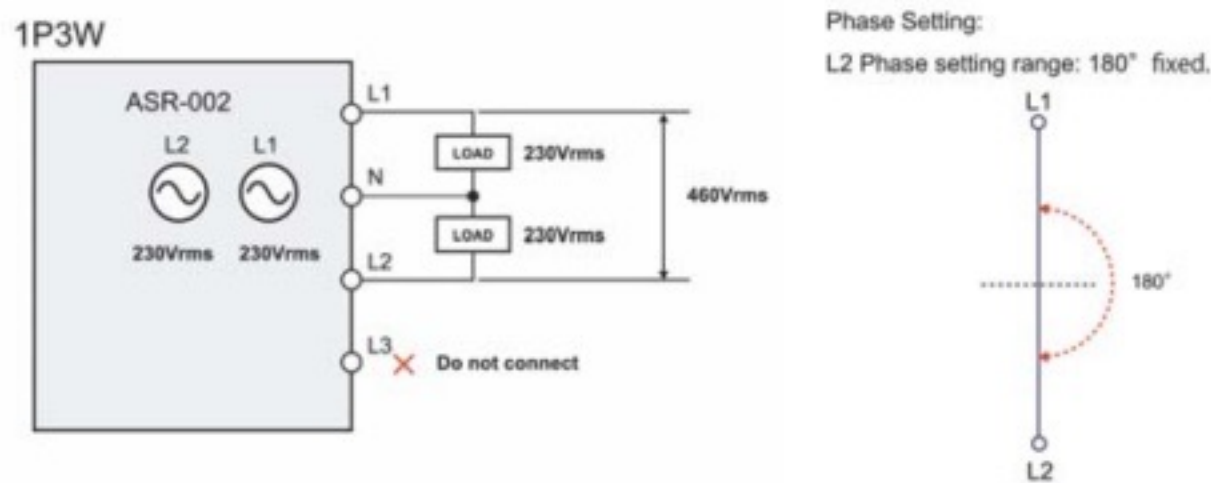

Three-Phase

3P4W WYE (Star) connection

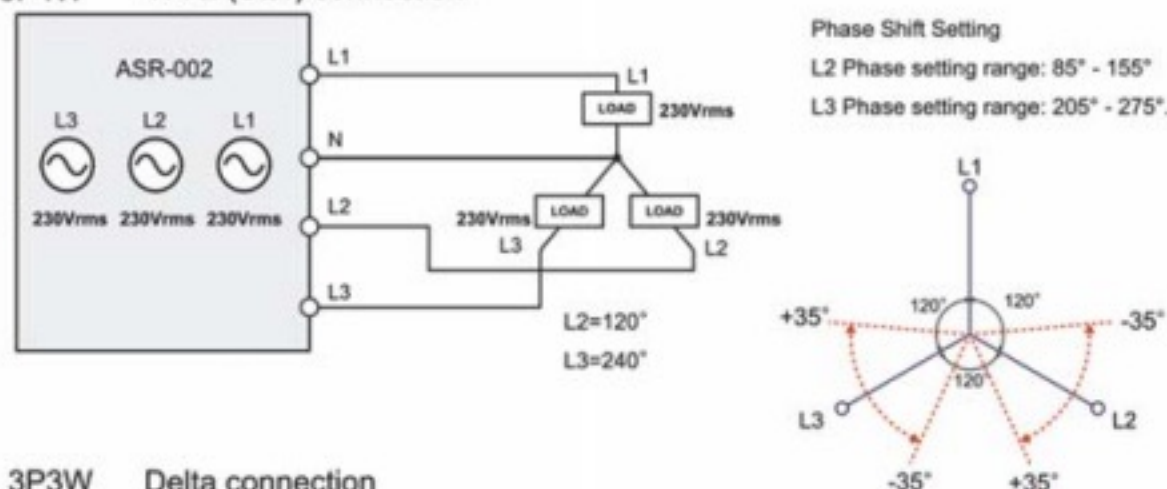

3P3W Delta connection

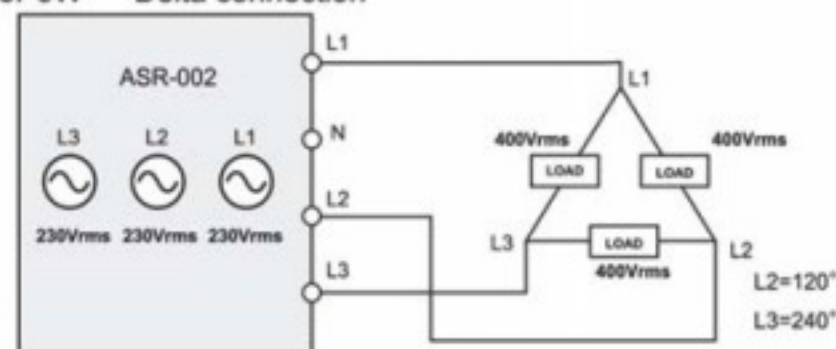

ISO-16750-2 Pretest with ASR-2000 Series

The applications of electronic technology products are growing at a fast pace in our daily lives. Other than mobile phones, tablet computers or general consumer electronics, electronic technology products are also utilized in the automotive industry, including LED headlights / taillights, HUD (Head Up Display), adaptive front lighting, tire pressure monitoring system, ABS system, GPS, windshield wiper, AV system, etc. In order to ensure the safety of drivers and passengers as well as driving, vehicle manufacturers are required to have a higher product stability and stricter quality control standards for electronic devices installed in the automobile.

Vehicle driving process is an extremely harsh challenge for electronics manufacturers manufacturing automotive electronics. Rough-road driving, vibration from a piston-engine, electrical systems exposed to low or high temperatures, temporary exposure to unknown chemical mixtures, alternator overvoltage, and momentary drop in supply voltage all may cause the product to malfunction. Therefore, the environmental reliability requirements of automotive electronic products will be more rigorously regulated. At present, the ISO-16750 has been widely adopted and referenced by relevant automotive electronics manufacturers. ISO-16750 contains 5 parts. In addition to ISO-16750-1 General, the rest are ISO-16750-2 Electrical loads, ISO-16750-3 Mechanical loads, ISO-16750-4 Climate loads, and ISO-16750-5 Chemical loads. The sequence mode of ASR-2000 can arbitrarily edit the voltage test waveform, which is very suitable for generating the verification waveform of ISO-16750-2 Electrical loads.

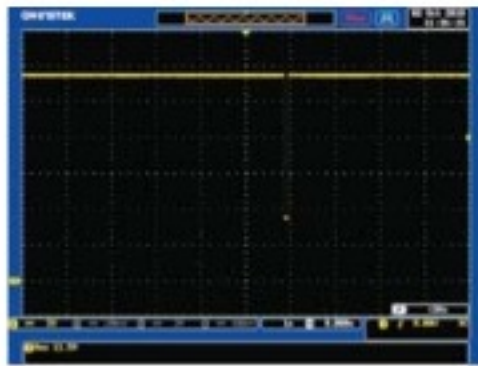

Momentary drop in supply voltage by ASR-2000 Series

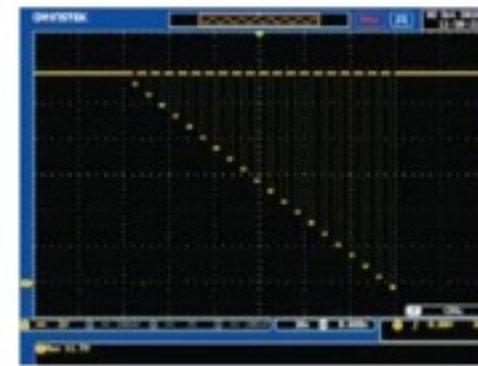

Reset behavior at voltage drop by ASR-2000 Series

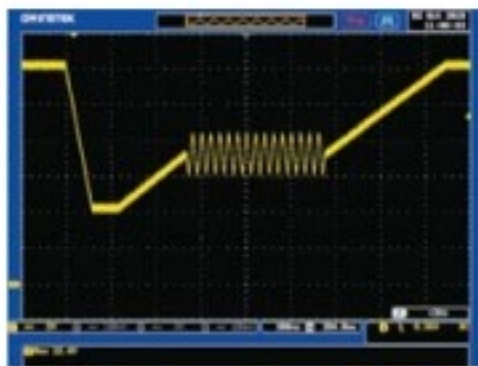

Starting profile by ASR-2000 Series

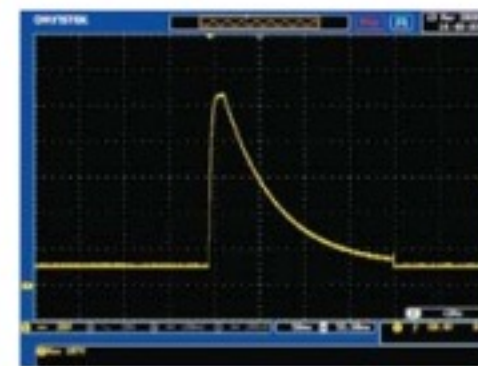

Load dump by ASR-2000 Series

ASR-2000 for the Applications of ISO-16750-2 Verification Items are as Follows:

Direct Current Supply Voltage

ASR-2000 Series provides the maximum / minimum supply voltage to verify the DUT of a full range of 12V power supply system and the 24V power supply system.

Overvoltage

ASR-2000 Series simulates the occurrence of overvoltage when the generator regulator fails.

Superimposed Alternating Voltage

The internal resistance parameter requirements of the power supply is not considered. ASR-2000 Series collocating with a signal generator can simulate power output to have the frequency change from 1 to 999.9Hz.

Slow Decrease And Increase of Supply Voltage

ASR-2000 Series sequence mode can simulate the battery being gradually charged and discharged.

Momentary Drop in Supply Voltage

Setting ASR-2000 Series power supply voltage to be interrupted instantaneously can simulate the effect caused by the melting of the conventional fuse component in another circuit. ASR-2000 Series can provide a minimum power interruption output of 100us.

Reset Behaviour at Voltage Drop

ASR-2000 Series can flexibly set different voltage drop times to test the reset behaviour of the DUT.

Starting Profile

The starting profile generated by ASR-2000 Series can verify the characteristics of the DUT during and after the car ignition.

Load Dump

Load dump is generated when the battery powering the generator or inductive component is instantaneously disconnected. If the parameter requirements of the input impedance of the power supply are not considered, editing the ASR-2000's Series sequence mode can obtain the waveforms of ISO-16750 test A and test B.

Reversed Voltage

ASR-2000 Series reversed output can meet the verification requirements of various automotive electronic products.

Vehicle Power Supply Simulation and Windshield Wiper Motor Application

With the popularity of technology and the evolution of electronic products, the electronic components used in today's cars are also becoming more diverse. Power windows, power mirrors, parking sensors, windshield wiper motors, etc., use batteries as a source of power. However, during the running of the vehicle, the supplied power supply is not constant. In order to ensure that the electronic components of the vehicle can still work normally under the condition of power supply fluctuation, the power supply can be used to simulate the abnormal output that may be generated by the battery to perform functional tests on the vehicle electronic products that is conducive to screen out defective components and products during the product testing phase.

Take the windshield wiper motor as an example. The processes of the windshield wiper motor operation generally include: 1 The rotation of the motor drives the back and forth of the windshield wiper. 2 Each time the windshield wiper is stationary, the windshield wiper must stay at the edge of the viewing angle without obstructing the driver's line of sight. 3 When the two windshield wipers are brushed at the same time, there should be no collision. The motor operating voltage range is DC: 10V ~ 15V, and its maximum operating current will be different at low speed or high speed. In order to verify that the varying power supply voltage does not affect the operation of the windshield wiper motor, the DC power supply can be used directly to generate a series of varying power outputs to the windshield wiper motor. The following figure shows the variable power supply for testing the windshield wiper motor. As follows, after a stable DC power supply, an unstable power supply output is provided to the windshield wiper motor and its operation is evaluated.

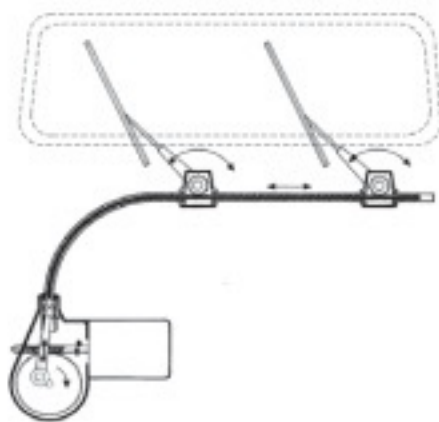

Schematic Windshield Wiper Motor

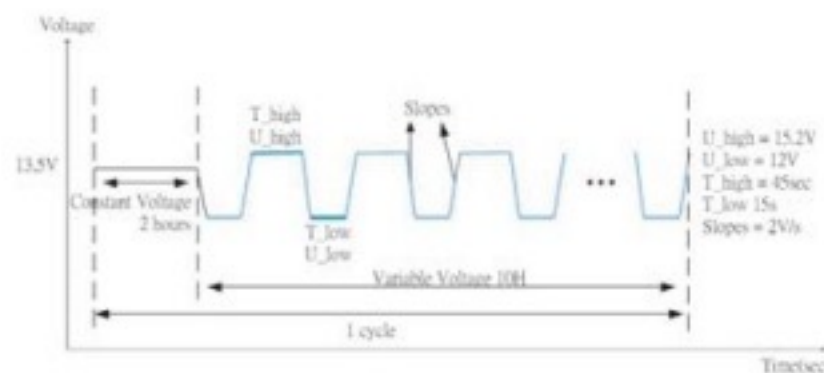

PSW-Series Test Scripts Function

The PSW Test Script function can be used to plan a continuous set of voltage changes. Users can edit the output voltage, current and execution time separately. For individual steps, OVP, OCP, voltage rise/fall slope or current rise/fall slope, and constant voltage or constant current priority mode can be set.

By editing the required power change output (eg. 200 cycles) on the Excel table, then loading the Excel table into the PSW stand-alone unit to perform the stand-alone automated execution, users can perform the above power output to verify the operation of the windshield wiper motor by a stand-alone unit.

Step	Point	Output	Time(sec)	Voltage (V)	Current (A)	OVP(V)	OCP(A)	Bleeder	TV Mode	V _{rise} up(V/s)	V _{rise} down(V/s)	I _{rise} up(A/s)	I _{rise} down(A/s)	Beeper	Sense Ave.	Jump to	Jump Cnt
1	start	On	7200	13.5	6	MAX	MIN	ON	CVHS	MAX	MAX	MAX	MAX				
2		On	1.5	12	6	MAX	MIN	ON	CVHS	MAX	MAX	2	MAX				
3		On	1.5	12	4	MAX	MIN	ON	CVHS	MAX	MAX	MAX	MAX				
4		On	1.6	15.2	6	MAX	MIN	ON	CVHS	MAX	2	MAX	MAX				
5		On	45	15.2	6	MAX	MIN	ON	CVHS	MAX	MAX	MAX	MAX				
6		On	1.6	12	6	MAX	MIN	ON	CVHS	MAX	MAX	2	MAX			3	569
7	end	On	1	13.5	6	MAX	MIN	ON	CVHS	MAX	MAX	MAX	MAX			1	199
8																	
9																	
10																	
11																	
12																	

With the Test Script function provided by GW Instek, it is very easy to perform the complex power output control under Excel editing. For users, there is no need to install an additional software, and there is no cumbersome step. Hence, using the PSW to perform complex sequential power outputs is a simple task.

PSW30-36 Internal resistance setting range : 0.000Ω~0.833Ω



PSW Built-in Resistance Variable Function Simulating Battery Output Resistance and Wire Harness

In addition, for the simulation of the real power supply situation at the factory, PSW can simulate the battery to supply power to the windshield wiper motor and activate PSW's built-in resistance variable function to set the built-in resistance value to simulate the battery output resistance and Wire Harness's resistance. By so doing, PSW can verify the output characteristics of the windshield wiper motor before it is installed in the car.

Car DC-DC Converter Effectiveness Evaluation

The output voltage of common electric vehicle batteries is high voltage ranging from 200V to 400V. In order to drive conventional 12V vehicle electronic devices, e.g. instrument panel display, lighting, electronic control unit (ECU), etc., the high-voltage output battery often transforms the high voltage of the battery into a 12V output through the step-down DC-DC converter. The step-down DC-DC converter is generally required to provide a stable voltage output, even if its input source cannot be maintained at a stable output. Therefore, the output characteristic test of the step-down DC-DC converter is very important. Generally, a high-voltage power supply can be used to simulate the input of the step-down DC-DC converter, and a large-capacity electronic load can be used to simulate vehicle electronic devices to test the output capability of the step-down DC-DC converter.

The PSU high-voltage model includes a voltage output range from 200V to 400V, and it can achieve a power output of 6KW through parallel connection, which can be used to simulate the battery output of the electric vehicle. The PEL-3955 can simulate the power consumption of a 12V automotive electronic device and output the monitored current to the oscilloscope for observation.

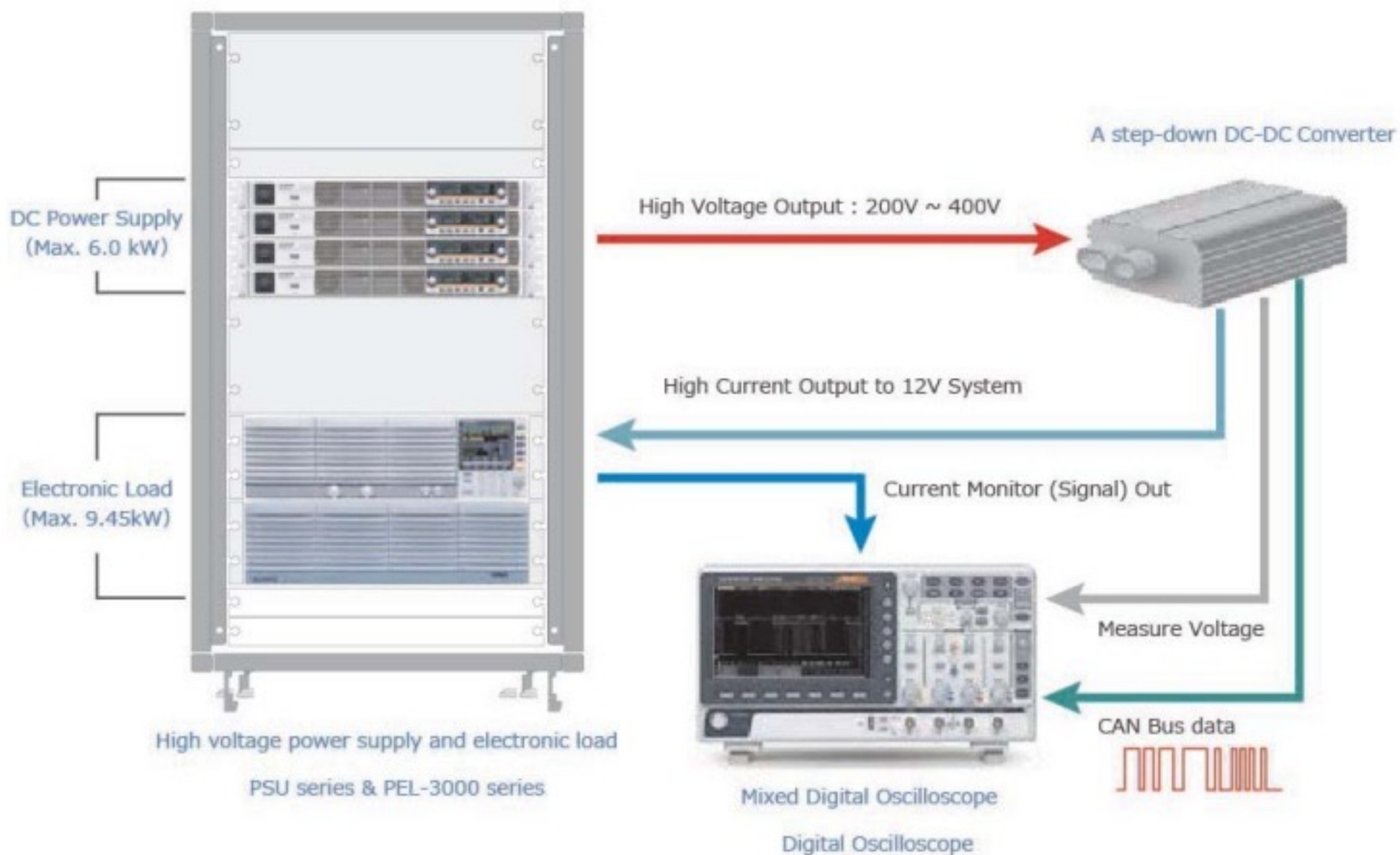

PSU can set the sequential power output to generate a set of varying power outputs to the step-down DC-DC converter to evaluate the Line Regulation characteristics of the step-down DC-DC converter. In addition, setting the PEL-3955 to operate under the Dynamic mode, users can evaluate the transient recovery time and load regulation of the step-down DC-DC converter. According to the load waveform of the vehicle device, users can edit the PEL-3955's sequence function to generate the load waveform so as to verify the output capability of the step-down DC-DC converter.

The Reliability Test of Vehicle Horn

Vehicle Horn is often used in transportation such as cars, motorcycles, trucks, buses, trains, etc. During the travel of the vehicle, the Vehicle Horn can sound to warn other vehicles or draw attention to avoid danger. If the sound intensity of the Vehicle Horn is to be measured during the burn-in test, the fanless PFR series power supply best meets such test requirements. The PFR series fanless design structure can quietly output power to the Vehicle Horn and the sequential output power function Test Script allows users to edit the burn-in test process.

PFR-Series

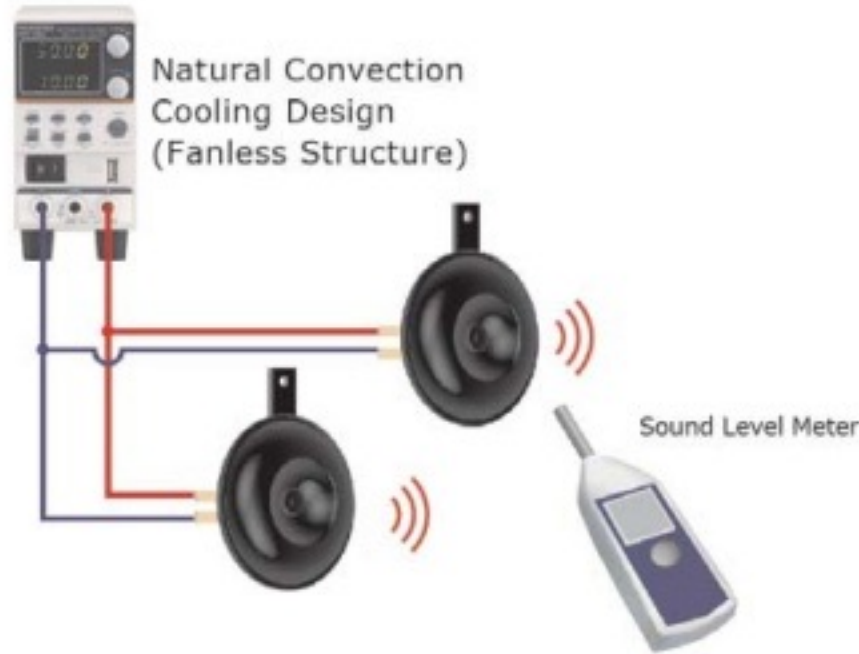

A Sound Measurement of the Vehicle Horn

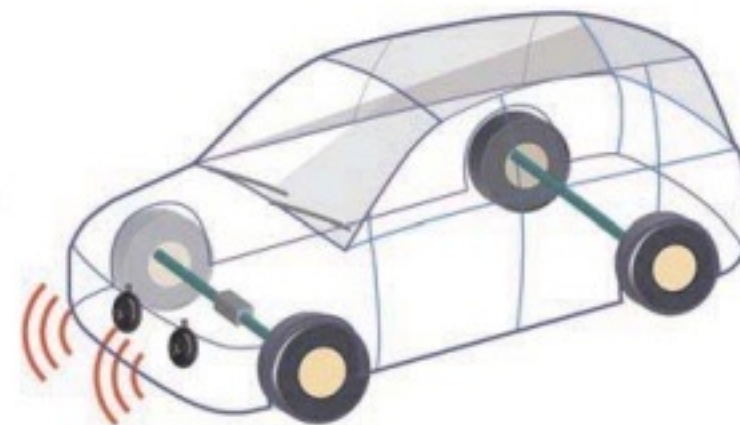

A Car Equipped Vehicle Horn

Edited Test Script to PFR for Burn-in Test :

	A	B	C	D	E	F
1	memo	Hone test				
2	DisplayItem	VI				
3	CycleItem	Number	Start Step	End step		
4	Cycle	50000	2	3		
5	Step	Point	Output	Time(sec)	Voltage(V)	Current(A)
6		1 Start	Off	0.5	0	7
7		2	On	1	13	7
8		3	Off	4	13	7
9		4 End	Off	0.5	0	7
10						

Voltage : 13.0V
Current : 7.0A
Cycle : 50,000



PFR-Series

PFR Output Waveform for Burn-in Test :

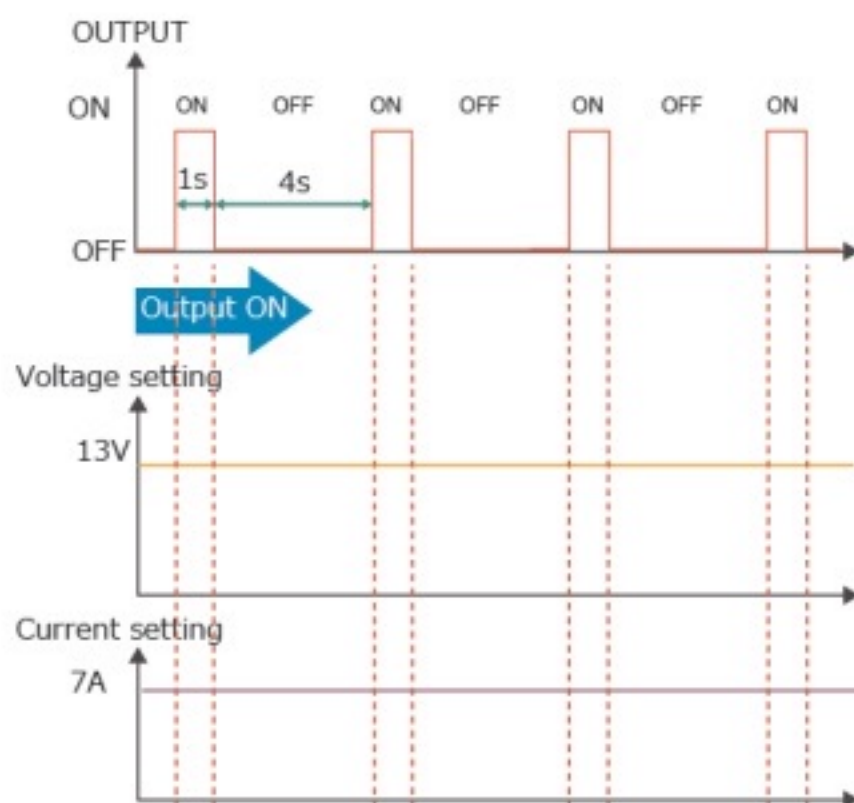

LED Test Application

The light-emitting diode is a special diode. Its main structure is the same as that of a common diode. It is composed of a P-type and N-type semiconductor. It uses the different characteristics of the forward bias and reverse bias of the P-N junction to turn on or off. The voltage-current output relationship when applying a forward bias to a light-emitting diode (see Fig. 1.). When the applied forward bias is greater than the V_f value, the diode begins to emit light, and the luminosity of the LED is directly related to the magnitude of the driving current. The larger the current value, the stronger the illuminance. If the current value is too large and exceeds the rated current value, the LED will have permanent damage.

In the actual test process of the LED, the conventional power supply output is usually under the CV mode. When the forward bias voltage is greater than the V_f value of the LED, the LED may be given a surge current due to the instantaneous conduction. If this surge current exceeds the rated maximum current value, it may cause permanent damage to the LED.

The CC priority mode function designed by GW Instek on the power supplies allows the output of the power supply to run under the CC mode preferentially to avoid the surge current and prevent the LED from being damaged by the surge current during the LED test.

Note: PFR series, PLR series, PSW series, PSU series, PSB-1000 series support the CC priority mode function.

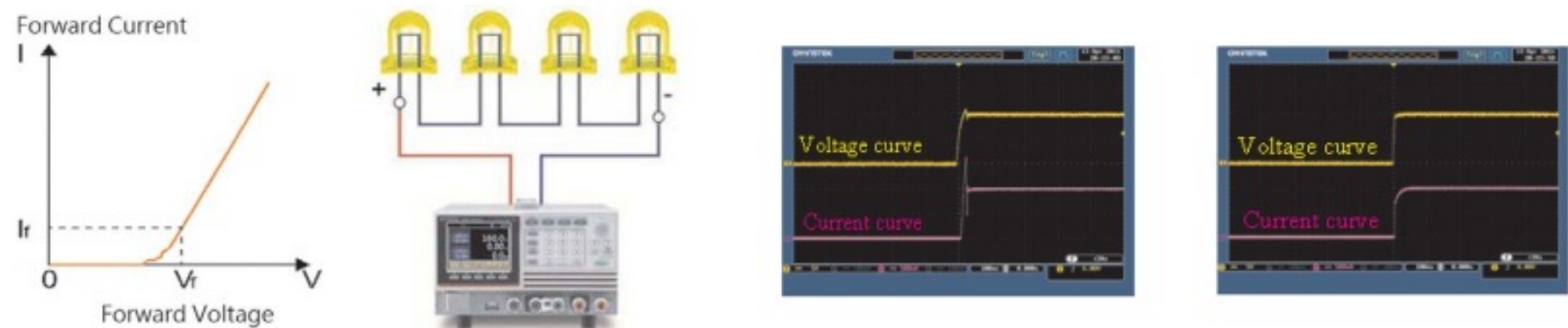

Fig. 1.: V-I Characteristic Chart

Illustrations of PSB-1000 Connecting to LEDs

Under the Conventional C.V Mode, Inrush Current and Surge Voltage Appeared at Forward Voltage (V_f) of LED

Under C.C Priority Mode, Inrush and Surge Voltage are Effectively Restrained

Precise Control RF Attenuator with PEL-3021

PSW+PEL-3000 can form a low-cost, high-accuracy, high-resolution current output controller. Typical RF Attenuators often use PIN diodes as microwave switches and microwave attenuators. In high frequency applications, providing a PIN diode forward bias or reverse bias can control whether the high frequency signal R_{Fin} can be output to R_{Fout} .

As shown in the figure below, the DC Block component is nearly short-circuited for the high-frequency R_{Fin} signal, so the R_{Fin} signal can pass directly. The RF Block is nearly open-circuited for the high-frequency R_{Fin} signal, so that the R_{Fin} signal is output to the R_{Fout} via the DC Block and the PIN diode. Precise control of the DC current flowing through the PIN diode allows precise determination of how much R_{Fin} signal is attenuated and then be output to R_{Fout} .

The PEL-3021 has a high resolution setting of 0.01mA. It can increase the DC control current by the increment of 10uA to observe the relationship between the measurement signal R_{Fin} and R_{Fout} , and further draw the attenuation curve of the RF Attenuator. The RF Attenuator's automated measurement can automatically increase the load current value using the PEL-3021's Sequence Function and simultaneously trigger the external device to conduct measurement using the Trigger Output function.

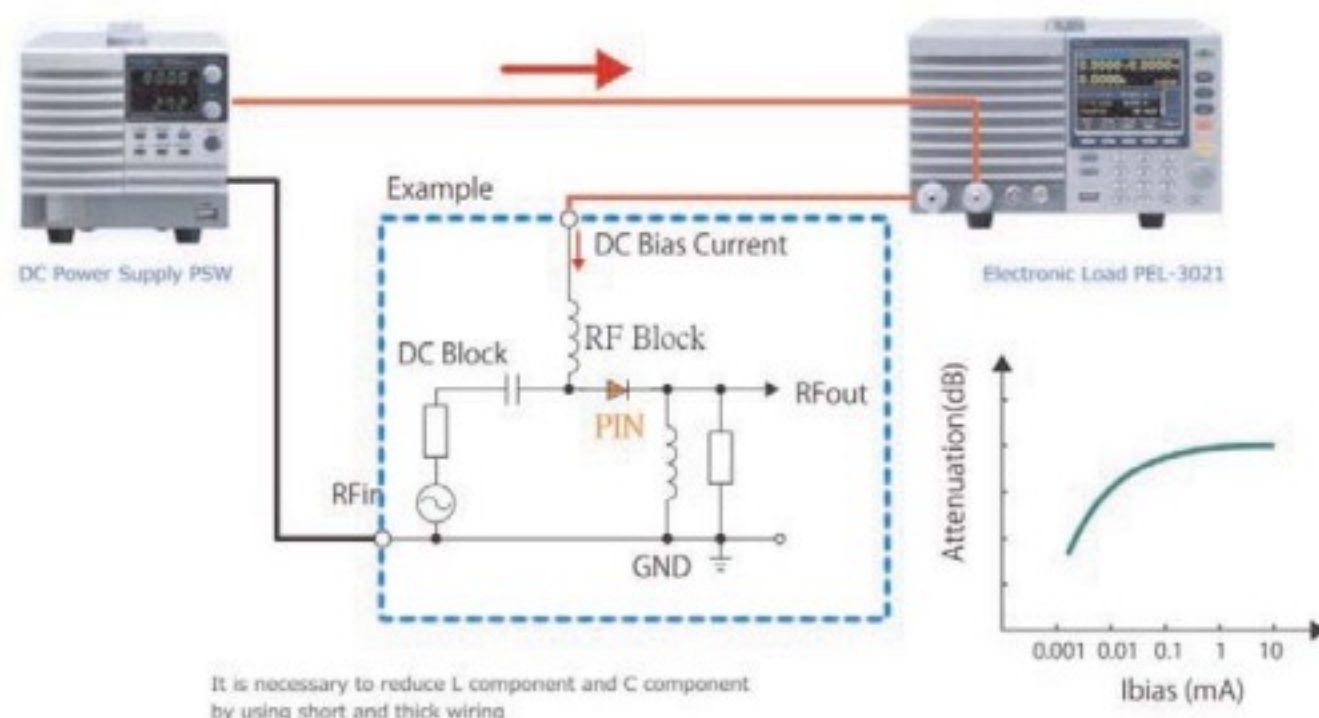

It is necessary to reduce L component and C component by using short and thick wiring

Bias Current vs. Attenuations

Reliability Test for Relay Using GW PSW Power Supply and PEL-3111 E. Load

How do you conduct relay connection point (N.O. / N.C.) tests? How do you test the life cycle of relay's connection point (N.O. / N.C.)? How do you evaluate the connection resistance of connection point (N.O. / N.C.) after multiple tests? How do you evaluate the speed for operating connection point (N.O. / N.C.)?

Relay, functioning to produce mechanical on-off movement by receiving electric signal to change electro magnet, is often applied to control other electronic device via receiving electronic signal. Voltage exerted on relay's coil allows current to pass through coil and magnetizes core. Armature is then be pulled by core due to electromagnetic force. Hence, a mechanical on-off movement is produced.

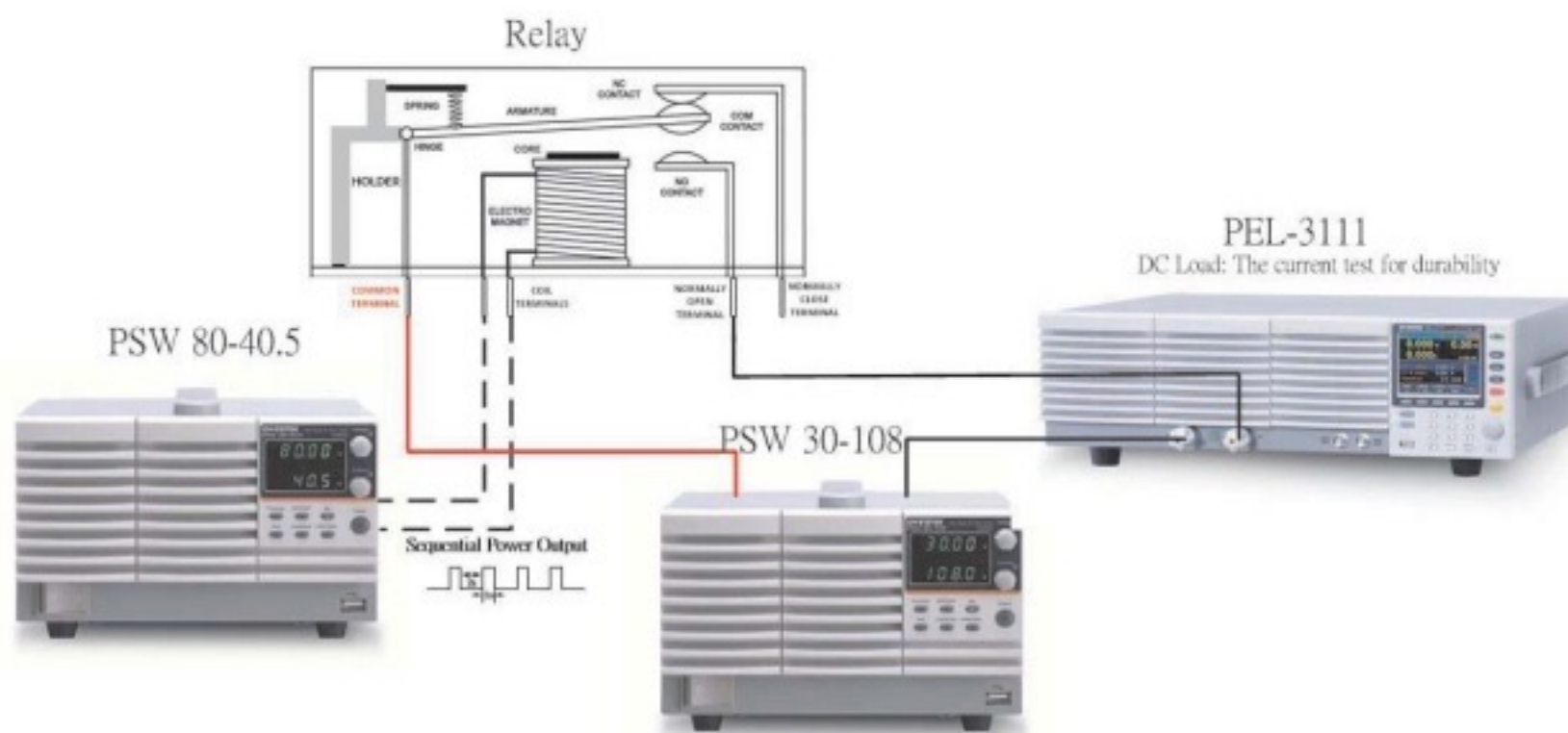

As shown on the top diagram, PSW 30-108, Relay and PEL-3111 are connected by series. PEL-3111 is set to 80A current sink. Each time, Relay's NO-COM is closed, NO-COM is tested for its current reliability. In the meantime, PSW 80-40.5 is utilized to output sequential power supply to produce control signal to control Relay's NO-COM.

One GW Instek PSW 80-40.5 can meet the actual measurement requirements via planning Relay's control signal. It not only controls signal's voltage, current, time and period, but also determines the number of operating cycle. There are totally 20,000 steps and each step can be set from 50ms to 20 days. The number of cycle can reach 1 billion or infinite by different specifications. Relay's control signal can only verify the mechanical characteristics of NO-COM and NC-COM. For further electric characteristic verification of NO-COM and NC-COM, PSW 30-108 and PEL-3111 must be concurrently utilized to produce C.C. output. Based upon Relay's specifications, the combined application of two instruments can conduct fast current switching test and provide large current verification, including current withstanding value and current withstanding time so as to ensure Relay's quality.

Waveforms Measured

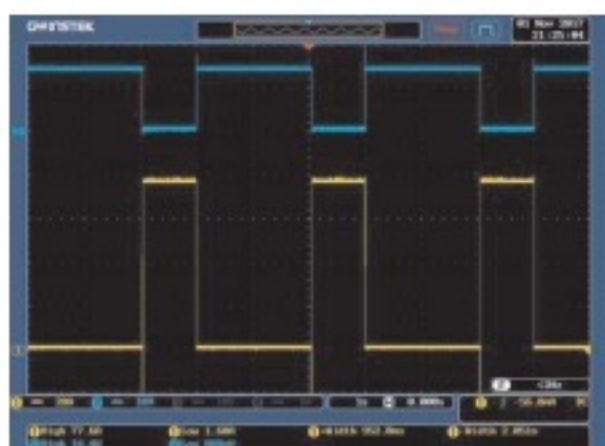

Ch1: Current Waveform



Ch2: Voltage Waveform for Relay 80A for 1s and 0A for 2s

Note:

NO: The NO pin is open to com pin in general unless the power provides to the coil. So it calls Normally Open Terminal of Relay.

NC: The NC pin is short to com pin in general unless the power provides to the coil. So it calls Normally Closed Terminal of Relay.

NO-COM: Its a connection status between NO pin and COM pin. It is short when power provides the coil; otherwise, it keeps open.

LED Pulse Current Assessment Test

Electronic load simulates actual loads by drawing current. The drawn current is called load current for power supply that can be used to test the characteristics of power supply or battery. By placing an electronic load in series with a power supply and a load (such as LED Module) and by setting different constant current conditions on the electronic load, the electronic load can draw different current targets from the system loop. The PEL-3000 series features the fast slew rate and the sequence function to simulate real and fast load changes.

The following diagram illustrates a pulse current test system composed of a programmable DC electronic load and a DC power supply to conduct tests on LED illumination characteristics.

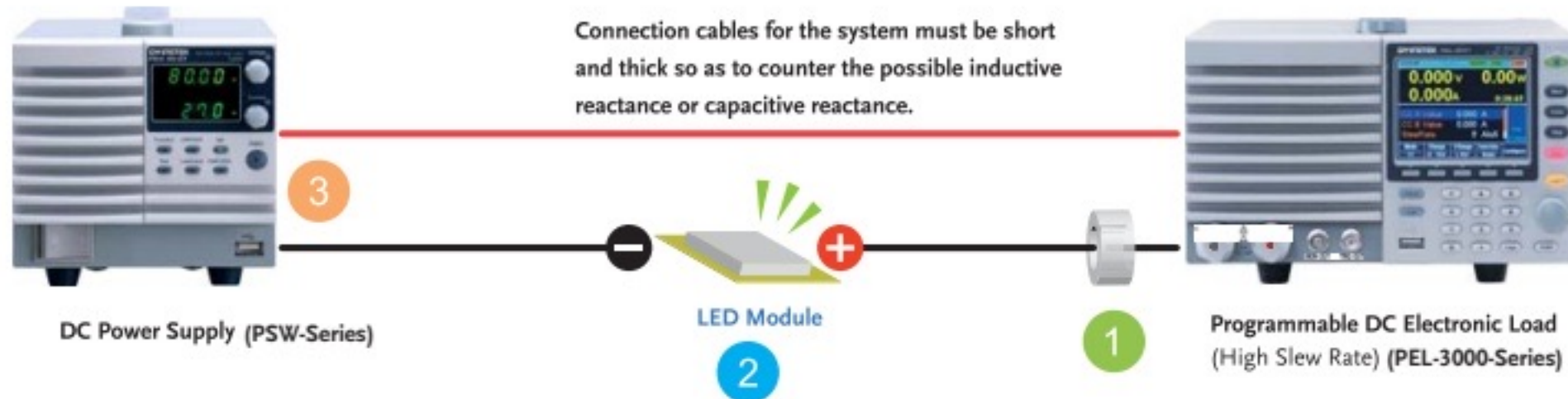

Programmable DC electronic loads, after settings, simulate DUT's pulse current (fast load changes) capability by drawing large and small current. Electronic loads produce pulse current and collocate with the sequence function to execute tests on fast or arbitrary waveform current. Oscilloscope monitors voltage waveform changes for LED and current source. Oscilloscope with a current probe can monitor current waveform in real time.

The lagged or delayed current will cause large transient power consumption when diode is on. Power supply outputs voltage (CV setting) CV is the required voltage for LED. Normally, it exceeds 1.5V.

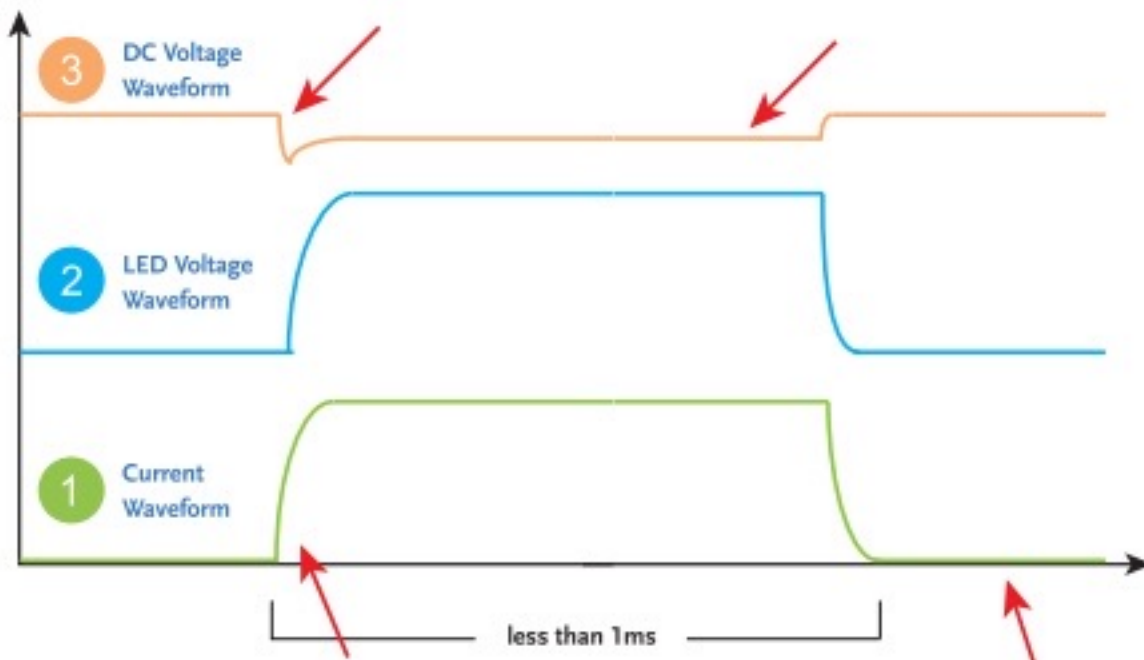

LED module will produce inductive reactance or capacitive reactance due to the length or diameter of wiring. The current waveform will experience delay.

Step-down current can be set as 0A. For a high speed electronic load, real electronic load current can not be 0A. Normally, there is current leakage.

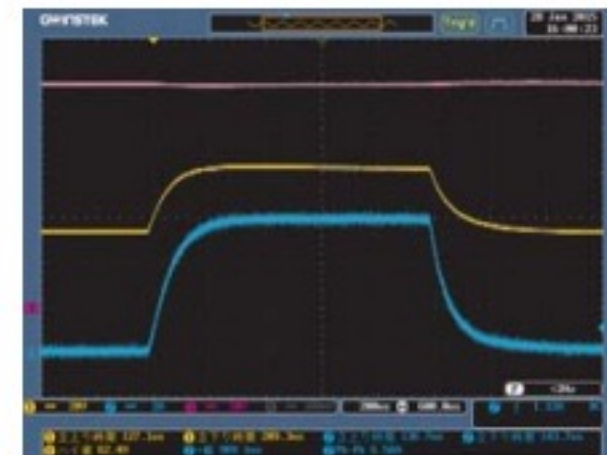

LED Pulse Current Assessment Test:

Benefits of PEL-3000 Series Applications

Construct A Large Pulse Current Source with Lower Costs

Normally, bipolar power is fast in response but it is also very expensive. Therefore, equipment for large pulse current is expensive. The feature of fast switching of electronic load can be used to construct pulse current source with lower costs.

Rating Current Requires Only 1.5V Input Voltage

Power supply outputs voltage - the required voltage of LED is approximately 1.5V, which requires only 1.5V peak value. PEL-3021 (175W) can satisfy 35A pulse current requirement with 1.5V voltage input.

For Constant Current Usages and Multiple DUT Applications

Constant current source can be used on changing characteristics for diode device of LED, surface processing (electroplating), pulse charging of rechargeable battery, burn-out of various fuses, and current sensor applications.

The Benefits That PFR-100 Power Supply Can Provide in Burn-in Test

Burn-in is one of many common methods manufacturers utilize to sort out defective components and products during the testing process of the electronic products. Burn-in test is normally conducted in the factory before shipment and after products are completely assembled. Burn-in process helps manufacturers sieve out defective components so as to prevent defective products from being sold to customers. Burn-in test requires additional space for power supplies and its power consumption for a long period of time will increase energy demand and electric bill. Burn-in test is a tremendous cost challenge to all manufacturers in terms of space, electric power and man power. To tackle this cost challenge, GW Instek PFR series can easily assist manufacturers in solving all difficult problems.

- * With respect to space, the PFR series provides better space flexibility in the limited test area by its 3U height (H:124/W:70/D:300 mm) and as light as a total weight of 2.5kg.
- * Pertaining to power saving, the PFR series, a high-efficiency power conversion power supply, adopts high-efficiency PWM design comparing with low-efficiency linear power supplies. Hence, the PFR series is capable of saving electricity during long-time burn-in test. Compared the same 100W output power supplies, the PFR series requires 143W of input power, while the linear power supplies with 0.5 efficiency require 200W of input power. After a full year of burn-in test, the PFR series will consume 1235 kWh and the linear power supplies will consume 1728kWh. For three years of burn-in test, the PFR series only consumes 3703kWh and linear power supplies consume 5184kWh.
- * The PFR series is a five-fold multi-range power supply, which allows users to arbitrarily adjust voltage and current within the rated power. This function allows users to adjust the voltage and current settings according to the maximum output power. Compared with the conventional 100W power supplies with maximum output 20V/5A, the 100W PFR-100L provides a maximum output of 50V@2A or 10V@10A, and the PFR-100M provides an output of up to 250V@0.4A or 50V@2A.

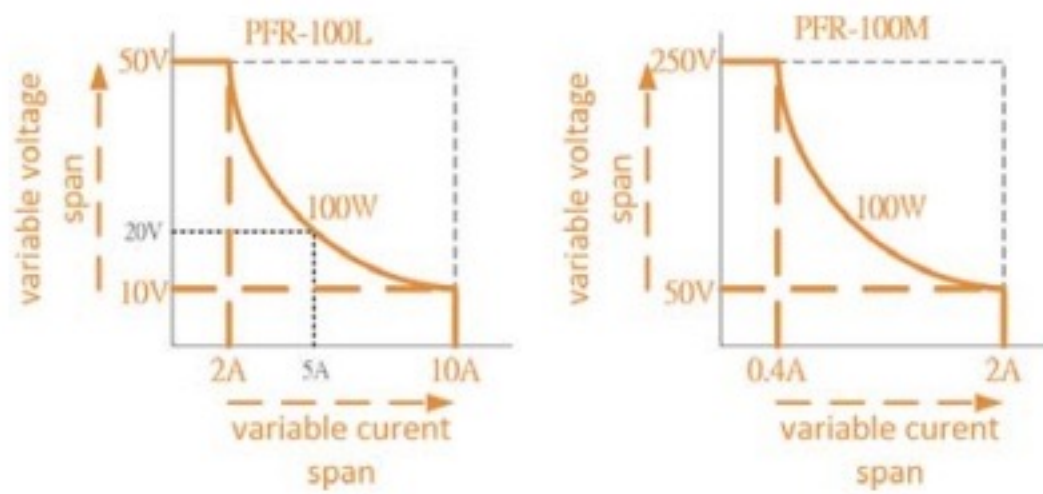

Voltage/Current Operating Area

- * In terms of personnel operation, the Test Script function of PFR series edits sequential power outputs based upon customer's burn-in test process and executes automatically during the burn-in procedures. Additionally, the built-in USB, RS- 232/485 communications of the PFR series allow testing personnel to remotely control or execute self-defined programs to realize automated tests and reduce manpower investment during burn-in process.
- * For power supplies connected to the inside of the Chamber, the phenomenon of voltage drop is often happened due to the long wiring. The PFR series provides the Remote Sense function to compensate the voltage drop so as to ensure an accurate voltage output to the DUT. The operator does not need to adjust voltage for voltage drop.
- * Conventional power supplies produce fan noise while in operation. Power supplies with fan design will absorb dust in the fan filter during long-term operation. The accumulated dust may affect the air circulation inside the power supply. Poor air circulation inside the power supply will cause the internal components of the power supply to function under a high-temperature environment. The components that work in the high-temperature environment for a long time will shorten the life cycle of the power supply. The fanless PFR series without fan noise is suitable for a quiet working environment, furthermore, fanless design is ideal for clean and quiet test environment (e.g. clean room). The fanless PFR series can prolong its life cycle during burn-in test.

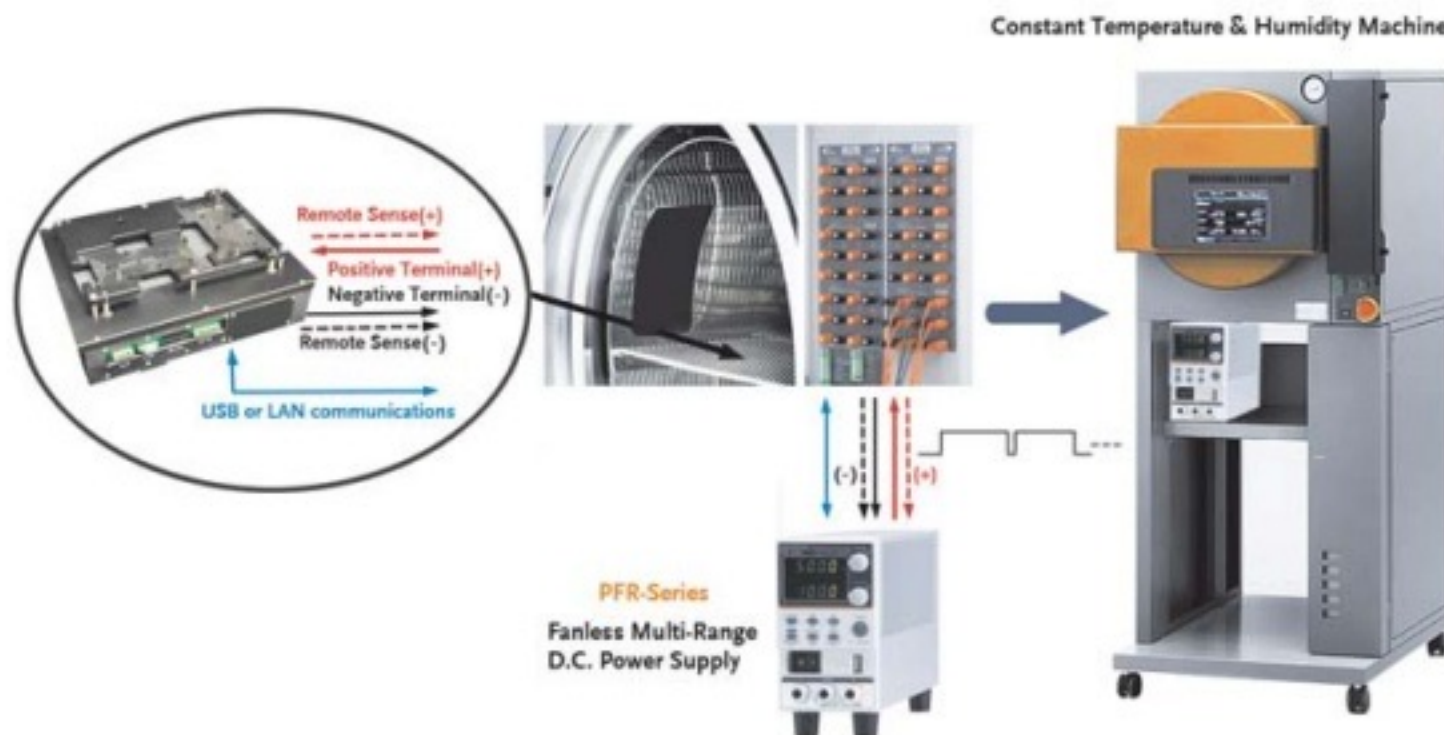

Schematic Diagram for Burn-in Test

Best-fitting Electronic Load for Your Test (Single Channel or Multiple Channels?)

Electronic loads are often simulated as the characteristics (constant resistance, constant voltage or constant current) of the DUTs to test whether the output capability of the battery, power supply, solar cell, or power supply unit meets user's requirements. Unlike using general resistive components to test batteries and power supplies, electronic loads can dynamically switch simulated resistors, voltages or currents, customize the rise and fall times of current sink, and even edit a complex and continuous load change.

THE BASIC APPLICATIONS OF THE SINGLE-CHANNEL DC ELECTRONIC LOAD PEL-3000 SERIES

Current Sensor Evaluation

The PEL-3000 series provides three current levels: high, medium and low. The minimum current resolution of 0.01 mA can be selected based upon the test requirements. If a PEL-3000 collocating with a DC power supply, a high-precision constant current power supply can be formed to evaluate the current sensor.



Current Sensor Evaluation

Solar Panel I-V Curve Display & MPPT Measurement

The MPPT Function can be done by the PEL-3000 series to simulate the operating current of the solar panel ranging from zero to the maximum current value, and at the same time measuring the output voltage and power of the solar panel to obtain the solar panel output voltage/current/power curve. The MPPT Function of the PEL-3000 series not only provides users with the Pmax, Vmp, Imp, Isc, Voc values of the solar panel, but also tracks the maximum power point of the solar panel in different shade conditions.

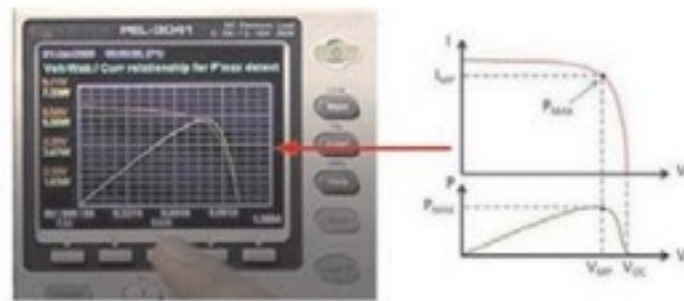

I-V Curve of The Solar Panel



Connections Between PEL-3041 and Solar Panel



Measurements for MPPT

- Remark:
- Pmax → Maximum Power Point
 - V_{MP} → Voltage at Maximum Power
 - I_{MP} → Current at maximum power
 - Voc → Open Circuit Voltage
 - Isc → Short Circuit Current

Best-fitting Electronic Load for Your Test (Single Channel or Multiple Channels?)

If users need to measure multiple sets of batteries or power supply units at a time, or evaluate multi-channel power output in the circuit, the multi-channel DC electronic load PEL-2000A will be the best measurement solution. PEL-2000A can evaluate the simultaneous power output capability of multiple power supplies, or test the output current of multiple power supplies by sequentially loading each output current according to the time interval defined by each output.

THE BASIC APPLICATIONS OF THE MULTI-CHANNEL DC ELECTRONIC LOAD PEL-2000A SERIES

The Output Test of PC Power Supply

Power supply output devices with small-power, multi-group and different specifications such as the ATX power supply for PCs can use PEL-2000A to evaluate the synchronous power output of multiple power supplies. A typical ATX power supply has 6 outputs. In order to ensure that the ATX power supply can provide sufficient power output when the 6 channels output simultaneously, the PEL-2000A can perform dynamic mode and load regulation tests on six outputs at the same time, or users can edit the Program mode to customize the severe test conditions to automatically determine the Pass or Fail of the ATX

ATX Power Supply Typ. Spec.

Total Power : 596.1W		Modules	Channels
+3.3V :	20A	PEL-2020A	PEL-2020L
+5V :	20A		PEL-2020R
-12V :	0.8A	PEL-2030A	PEL-2020L
+12V1 :	17A		PEL-2020R
+12V2 :	17A	PEL-2040A	PEL-2040
+5VSB :	2.5A	PEL-2041A	PEL-2041



Test Diagram for ATX Power Supply

Battery Evaluation Test

Automated testing of high-speed battery charge and high-speed discharge can be achieved by using the PEL-2000A electronic load module in series and parallel with the power supply. The automated switching operation between the module and the module of the PEL-2000A can greatly shorten the test time and increase the reliability during the measurement process while comparing with the manual operation.

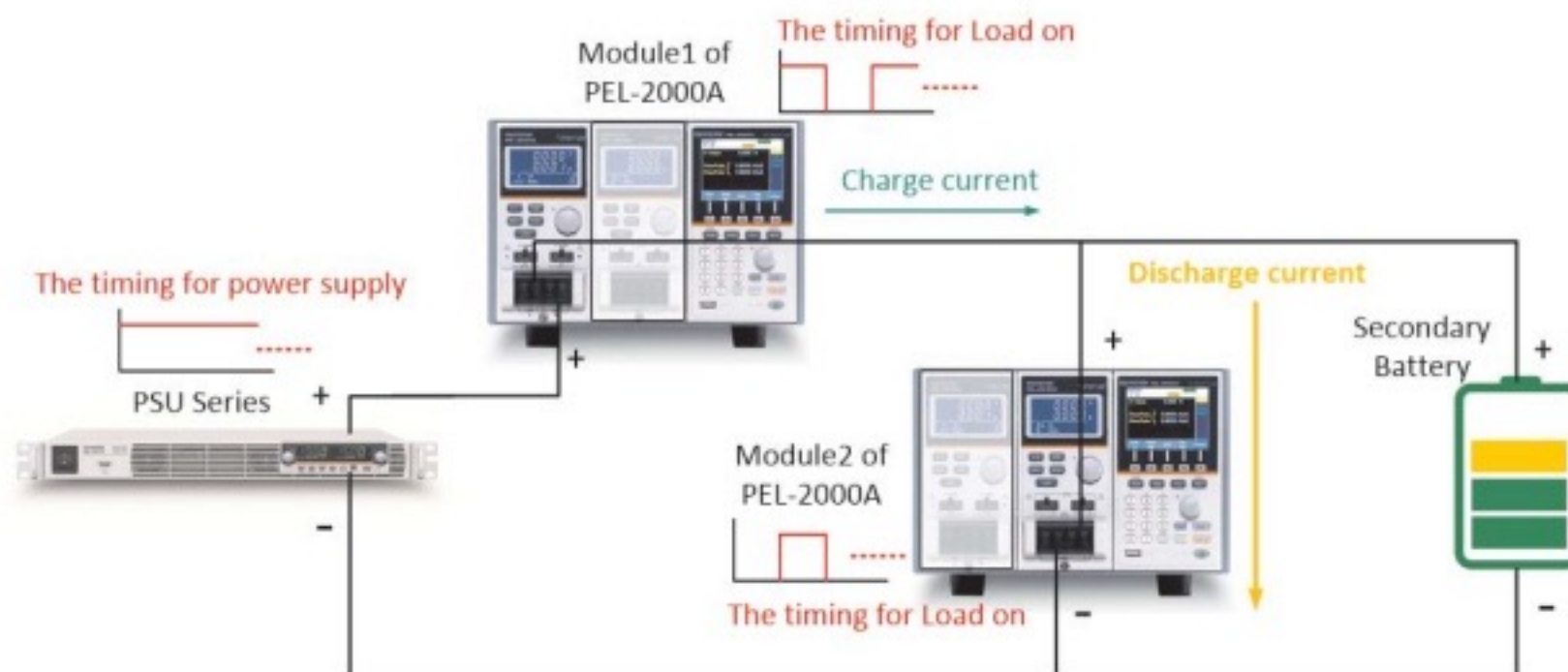

Automated Charge/ Discharge Test with PEL-2000A

Automotive Wire Harness Performance Test System

Automotive Wire Harness Uses Multi-Channel and Continuous Power Supply Test System

Electric wire, installed in the automobile, plays an important role in supplying power and transmitting signals. The importance of electric wire has increased in the wake of the evolution of automotive electronization. For safe and comfortable driving, the reliability test for automotive wire harness is essential. The multi-channel test system, composed of a DC electronic load and a large current power supply, saves time in testing each wire harness and saves space for placing test instruments.

DC power supply and DC electronic load can be rack mounted by customers' electric power wiring test requirements. The following diagram shows many units of PEL-2000A series were used for providing power to multi-channel automotive wire harness in a long period of time.

The PEL-2000A series saves system rack space and costs. The series can flexibly arrange the required number of channels according to the actual requirements of DUTs. The series can also simulate many automotive devices to conduct continuous tests.

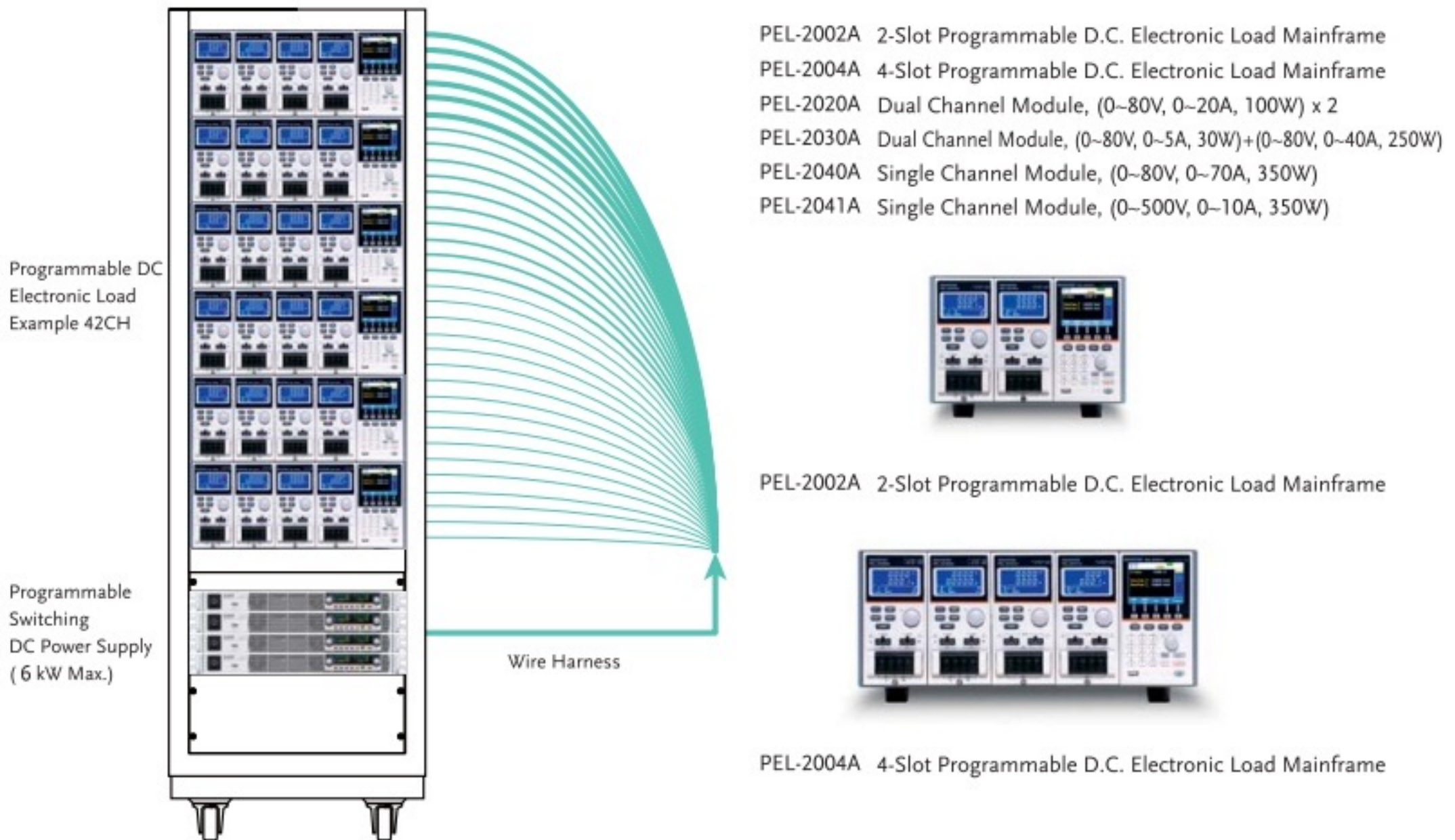

The PEL-2000A series saves system rack space and costs. The PEL-2000A series programmable DC electronic load, via USB or GPIB, can conduct independent control over multiple channels. By using custom-made monitor software, the series can simultaneously control many independent channels.

Test terminal and rack can be custom made. Users' test wire harness required terminal can be jointly mounted on a rack.

Test Script Applications-Solving Complex Test Patterns

The uniqueness of GW Instek Test Script function is to streamline test operator's complex measurement work by directly planning a set of changing voltage and current parameters via Microsoft Excel and uploading the edited Excel file to GW Instek power supplies so as to execute sequential power outputs. The following four test applications with different test patterns were easily executed by GW Instek Test Script function without software programming.

Test Script allows users to run repetitive cycle tests by setting parameters including output voltage, current, time, cycle, OVP, OCP, Bleeder, etc. Four GW Instek Power supplies support Test Script, including PFR, PSU, PSB, and PSW.



Pattern 1: Pulse output

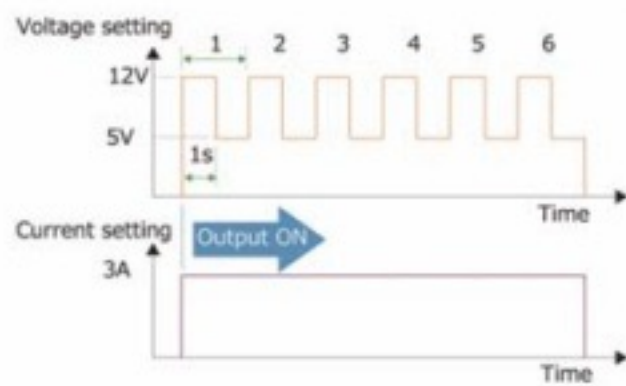

Pattern Setting

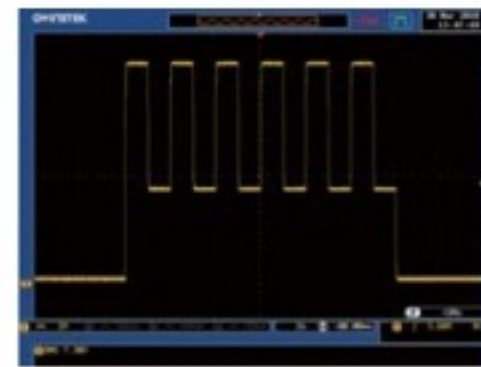

Waveform Measurement

Settings: Set and execute a pattern that switches 12V/1sec to 5V/1sec for 6 times with the current setting of 3A.

Test Script Setting :

28	Cycle/Items	Number	Start Step	End Step							
29	Cycle										
30											
31	Step	Point	Output	Time(sec)	Voltage (V)	Current (A)	Beeper	Sense Aver	Jump to	Jump Cnt	Trig
32	1	Start	On	0.5	0	0					
33	2		On	1	12	3	On				
34	3		On	1	5	3			2	5	
35	4	end	On	1	0	0					

Parrern 2: Aging test with a controlled rise time

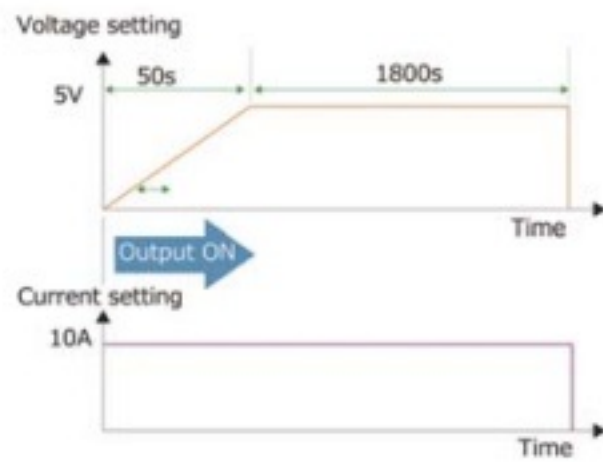

Pattern Setting



Waveform Measurement

The output voltage rises from 0V to 5V in 50 seconds at current setting of 10A and maintains the settings for 30 minutes and then output is turned off automatically.

Test Script Setting :

Step	Point	Output	Time(sec)	Voltage (V)	Current (A)	OVP(V)	OCP(A)	Bleeder	IV Mode	Var up(V/Hz)	Var down(V/Hz)	Ir up(A/Hz)	Ir down(A/Hz)	
27														
28	Cycle/Items	Number	Start Step	End Step										
29	Cycle	1	1	2										
30														
31	Step	Point	Output	Time(sec)	Voltage (V)	Current (A)	OVP(V)	OCP(A)	Bleeder	IV Mode	Var up(V/Hz)	Var down(V/Hz)	Ir up(A/Hz)	Ir down(A/Hz)
32	1	Start	On	50	5	10	MAX	MAX	ON	CVLS	0.1	MAX	MAX	MAX
33	2	end	On	1800	5	10	MAX	MAX	ON	CVHS	MAX	MAX	MAX	MAX
34	3													

Parrern 3: Add burst noise

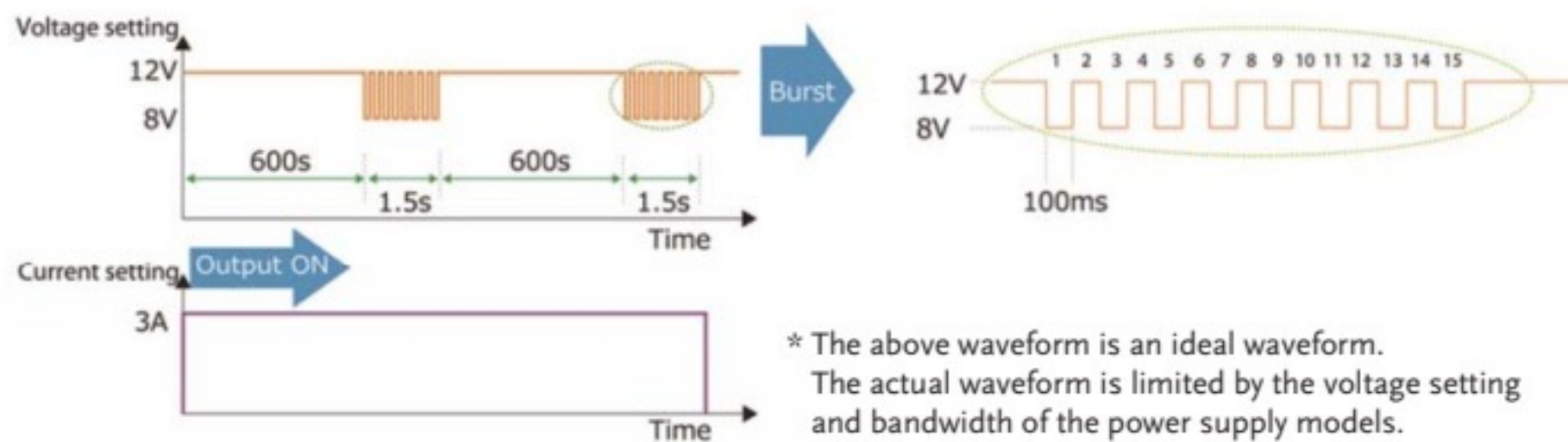

Pattern Setting

* The above waveform is an ideal waveform. The actual waveform is limited by the voltage setting and bandwidth of the power supply models.

Burst signals are applied in the middle of the constant voltage output. For example, a continuous voltage output generates a burst noise that fluctuates between 12V and 8V. Each burst signal is 100ms and the burst signals last 1.5s that appears after every 10 minutes (600 s) of constant 12V output.

Test Script Setting :

Step	Point	Output	Time(sec)	Voltage (V)	Current (A)	OVP(V)	OCP(A)	Bleeder	IV Mode	Jump to	Jump Cnt	Trig	
27													
28	Cycle/Items	Number	Start Step	End Step									
29	Cycle	1	1	2									
30													
31	Step	Point	Output	Time(sec)	Voltage (V)	Current (A)	OVP(V)	OCP(A)	Bleeder	IV Mode	Jump to	Jump Cnt	Trig
32	1	Start	On	600	12	3	MAX	MAX	ON	CVHS			
33	2	On	0.1	8	3	MAX	MAX	ON	CVHS				
34	3	On	0.1	12	3	MAX	MAX	ON	CVHS	2	7		
35	4	End	On	0.1	12	3	MAX	MAX	ON	CVHS	1	10000	
36	5												

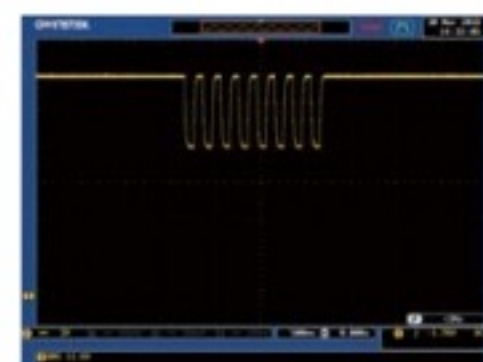

Waveform Measurement

Parrern 4: Lifetime test

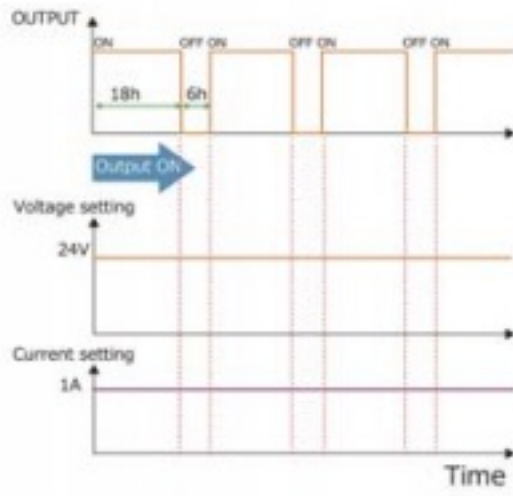

Pattern Setting

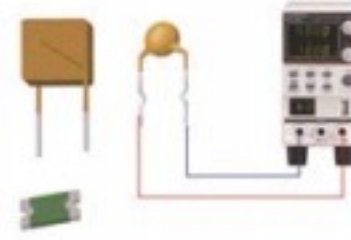

Waveform Measurement

For durability tests such as lights, heaters, etc., pattern that repeats for 18-hour output on and 6-hour output off for 100 days is as follows.

Test Script Setting :

27															
28	Cycle/Item Number	Start Step	End Step												
29	Cycle	0	1	2											
30															
31	Step	Point	Output	Time(sec)	Voltage (V)	Current (A, OVP(V))	OCF(A)	Bleeder	IV Mode	V _{set up} (V/A)	V _{set down} (V)	I _{set up} (A/m)	I _{set down} (A/R(ohm))	Beeper	
32	1	Start	On	64800	24	1 MAX	MAX	ON	CVHS	MAX	MAX	MAX	MAX	MIN	
33	2	End	Off	21600	24	1 MAX	MAX	ON	CVHS	MAX	MAX	MAX	MAX	MIN	
34	3														

Parrern 5: PPTC device (Resettable fuse) test

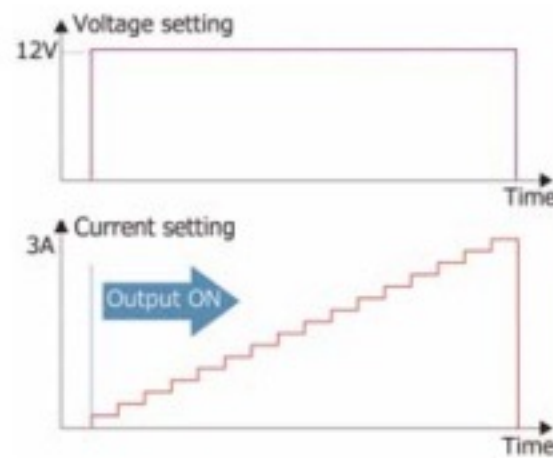

Pattern Setting

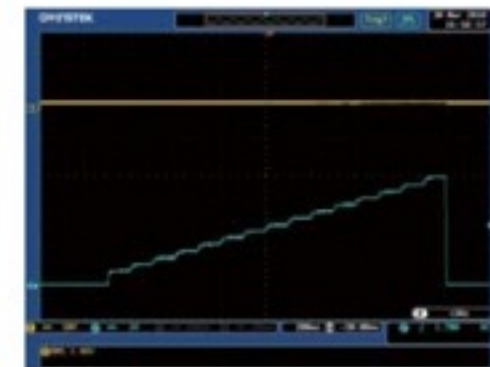

Waveform Measurement

A test example of self-resetting PTC verifies its open circuit characteristic by increasing current from 0 to 3A with 16-step resolutions. Test Script can easily execute a series of different currents under a constant voltage setting to test the blown and reset characteristic of a self-resetting PTC.

Test Script Setting :

27															
28	Cycle/Item Number	Start Step	End Step												
29	Cycle	1	1	16											
30															
31	Step	Point	Output	Time(sec)	Voltage (V)	Current (A, OVP(V))	OCF(A)	Bleeder	IV Mode	V _{set up} (V/A)	V _{set down} (V)	I _{set up} (A/m)	I _{set down} (A/R(ohm))	Beeper	
32	1	Start	On	0.1	12	0.1875 MAX	MAX	ON	CCHS	MAX	MAX	MAX	MAX	MIN	
33	2	On	On	0.1	12	0.375 MAX	MAX	ON	CCHS	MAX	MAX	MAX	MAX	MIN	
34	3	On	On	0.1	12	0.5625 MAX	MAX	ON	CCHS	MAX	MAX	MAX	MAX	MIN	
35	4	On	On	0.1	12	0.75 MAX	MAX	ON	CCHS	MAX	MAX	MAX	MAX	MIN	
36	5	On	On	0.1	12	0.9375 MAX	MAX	ON	CCHS	MAX	MAX	MAX	MAX	MIN	
37	6	On	On	0.1	12	1.125 MAX	MAX	ON	CCHS	MAX	MAX	MAX	MAX	MIN	
38	7	On	On	0.1	12	1.3125 MAX	MAX	ON	CCHS	MAX	MAX	MAX	MAX	MIN	
39	8	On	On	0.1	12	1.5 MAX	MAX	ON	CCHS	MAX	MAX	MAX	MAX	MIN	
40	9	On	On	0.1	12	1.6875 MAX	MAX	ON	CCHS	MAX	MAX	MAX	MAX	MIN	
41	10	On	On	0.1	12	1.875 MAX	MAX	ON	CCHS	MAX	MAX	MAX	MAX	MIN	
42	11	On	On	0.1	12	2.0625 MAX	MAX	ON	CCHS	MAX	MAX	MAX	MAX	MIN	
43	12	On	On	0.1	12	2.25 MAX	MAX	ON	CCHS	MAX	MAX	MAX	MAX	MIN	
44	13	On	On	0.1	12	2.4375 MAX	MAX	ON	CCHS	MAX	MAX	MAX	MAX	MIN	
45	14	On	On	0.1	12	2.625 MAX	MAX	ON	CCHS	MAX	MAX	MAX	MAX	MIN	
46	15	On	On	0.1	12	2.8125 MAX	MAX	ON	CCHS	MAX	MAX	MAX	MAX	MIN	
47	16	End	On	0.1	12	3 MAX	MAX	ON	CCHS	MAX	MAX	MAX	MAX	MIN	
48															

Model Number Index

AE		
AEL-5002-350-18.75	50V/18.75A/1875W AC & DC Electronic Load	D119
AEL-5003-350-28	350V/28A/2800W AC & DC Electronic Load	D119
AEL-5004-350-37.5	350V/37.5A/3750W AC & DC Electronic Load	D119
AEL-5006-350-56	350V/56A/5600W AC & DC Electronic Load	D119
AEL-5008-350-75	350V/75A/7500W AC & DC Electronic Load	D119
AEL-5012-350-112.5	350V/112.5A/11250W AC & DC Electronic Load	D119
AEL-5015-350-112.5	350V/112.5A/15000W AC & DC Electronic Load	D119
AEL-5019-350-112.5	350V/112.5A/18750W AC & DC Electronic Load	D119
AEL-5023-350-112.5	350V/112.5A/22500W AC & DC Electronic Load	D119
AEL-5002-425-18.75	425V/18.75A/1875W AC & DC Electronic Load	D119
AEL-5003-425-28	425V/28A/2800W AC & DC Electronic Load	D119
AEL-5004-425-37.5	425V/37.5A/3750W AC & DC Electronic Load	D119
AEL-5006-425-56	425V/56A/5600W AC & DC Electronic Load	D119
AEL-5008-425-75	425V/75A/7500W AC & DC Electronic Load	D119
AEL-5012-425-112.5	425V/112.5A/11250W AC & DC Electronic Load	D119
AEL-5015-425-112.5	425V/112.5A/15000W AC & DC Electronic Load	D119
AEL-5019-425-112.5	425V/112.5A/18750W AC & DC Electronic Load	D119
AEL-5023-425-112.5	425V/112.5A/22500W AC & DC Electronic Load	D119
AEL-5003-480-18.75	480V/18.75A/2800W AC & DC Electronic Load	D119
AEL-5004-480-28	480V/28A/3750W AC & DC Electronic Load	D119
AP		
APS-001	Accessory -- GPIB Interface Card	D129
APS-002	Accessory -- RS-232/USB Interface Card	D129
APS-003	Accessory -- Output Voltage Capacity (0 ~ 600Vrms)	D129
APS-004	Accessory -- Output Frequency Capacity (45~999.9Hz)	D129
APS-007	Accessory -- RS-232 Interface Card	D129
APS-008	Accessory -- Air Inlet Filter	D129
APS-7050	500VA Programmable Linear AC Power Source	D83
APS-7100	1000VA Programmable Linear AC Power Source	D83
APS-7050E	500VA AC Power Source	D87
APS-7100E	1000VA AC Power Source	D87
APS-7200	2000VA Programmable Linear AC Power Source	D83
APS-7300	3000VA Programmable Linear AC Power Source	D83
AS		
ASR-001	Accessory -- Air Inlet Filter	D129
ASR-002	Accessory -- External Three Phase Control Unit	D129
ASR-2050	500VA Programmable AC/DC Power Source	D79
ASR-2100	1000VA Programmable AC/DC Power Source	D79
ASR-2050R	500VA Programmable AC/DC Power Source for 3U 1/2 Rack Mount	D79
ASR-2100R	1000VA Programmable AC/DC Power Source for 3U 1/2 Rack Mount	D79
ASR-3200	2kVA Programmable AC/DC Power Source	D73
ASR-3300	3kVA Programmable AC/DC Power Source	D73
ASR-3400	4kVA Programmable AC/DC Power Source	D73
ASR-3400HF	4kVA Programmable AC/DC Power Source	D73
GE		
GET-001	Accessory -- Extended Terminal for 30V/80V/160V Models	D129
GET-002	Accessory -- Extended Terminal for 250V/800V Models	D129
GET-003	Accessory -- Extended Universal Power Socket	D129
GET-004	Accessory -- Extended European Power Socket	D129
GET-005	Accessory -- Extended European Terminal for 30V/80V/160V Models	D129
GP		
GPC-3060D	375W, 3-Channel, Linear D.C. Power Supply	D66
GPC-6030D	375W, 3-Channel, Linear D.C. Power Supply	D66
GPD-2303S	180W, 2-Channel, Programmable Linear D.C. Power Supply	D58
GPD-3303D	195W, 3-Channel, Programmable Linear D.C. Power Supply	D58
GPD-3303S	195W, 3-Channel, Programmable Linear D.C. Power Supply	D58
GPD-4303S	195W, 4-Channel, Programmable Linear D.C. Power Supply	D58
GPE-1326	192W, Single Channel, Linear D.C. Power Supply	D64
GPE-2323	192W, 2-Channel, Linear D.C. Power Supply	D64
GPE-3323	217W, 3-Channel, Linear D.C. Power Supply	D64
GPE-4323	212W, 4-Channel, Linear D.C. Power Supply	D64
GPP-1326	Single-Output Programmable DC Power Supply	D56
GPP-2323	Dual-Output Programmable DC Power Supply	D56
GPP-3323	Three-Output Programmable DC Power Supply	D56
GPP-3060	385W Triple-channel Programmable DC Power Supply	D52
GPP-3650	385W Triple-channel Programmable DC Power Supply	D52
GPP-4323	Four-Output Programmable DC Power Supply	D56
GPP-6030	385W Triple-channel Programmable DC Power Supply	D52
GPR-0830HD	240W Linear D.C. Power Supply	D67
GPR-11H30D	330W Linear D.C. Power Supply	D67
GPR-1810HD	180W Linear D.C. Power Supply	D68
GPR-1820HD	360W Linear D.C. Power Supply	D67
GPR-3060D	180W Linear D.C. Power Supply	D68
GPR-30H10D	300W Linear D.C. Power Supply	D67
GPR-3510HD	350W Linear D.C. Power Supply	D67
GPR-6030D	180W Linear D.C. Power Supply	D68
GPR-6060D	360W Linear D.C. Power Supply	D67
GPR-7550D	375W Linear D.C. Power Supply	D67
GPS-001	Accessory -- Knob, Voltage/Current Protection Knob	D129

GPS-1830D	54W Linear D.C. Power Supply	D69
GPS-1850D	90W Linear D.C. Power Supply	D69
GPS-3030D	90W Linear D.C. Power Supply	D69
GPS-3030DD	90W Linear D.C. Power Supply	D69
GPS-2303	180W, 2-Channel, Linear D.C. Power Supply	D65
GPS-3303	195W, 3-Channel, Linear D.C. Power Supply	D65
GPS-4303	200W, 4-Channel, Linear D.C. Power Supply	D65
GPW-001	Accessory -- UL/CSA Power Cord, 3000mm	D129
GPW-002	Accessory -- VDE Power Cord, 3000mm	D129
GPW-003	Accessory -- PSE Power Cord, 3000mm	D129
GPW-005	Accessory -- Power Cord, 3000mm	D129
GPW-006	Accessory -- Power Cord, 3000mm	D129
GPW-007	Accessory -- Power Cord, 3000mm	D129
GR		
GRA-401	Accessory -- Rack Adapter Kit, 19", 4U Size	D129
GRA-403	Accessory -- Rack Adapter Kit, 19", 4U Size	D129
GRA-407	Accessory -- Rack Adapter Kit, 19", 4U Size	D129
GRA-408	Accessory -- Rack Adapter Kit, 19", 4U Size	D129
GRA-409	Accessory -- Rack Adapter Kit, 19", 4U Size	D129
GRA-410-E	Accessory -- Rack Mount Kit (EIA), 19", 3U Size	D129
GRA-410-J	Accessory -- Rack Mount Kit (JIS), 19", 3U Size	D129
GRA-413-E	Accessory -- Rack Mount Kit (EIA), 19", 3U Size for PEL-3211	D129
GRA-413-J	Accessory -- Rack Mount Kit (JIS), 19", 3U Size for PEL-3211	D129
GRA-414-E	Accessory -- Rack Mount Kit (EIA), 19", 3U Size for PEL-3021/3041/3111	D129
GRA-414-J	Accessory -- Rack Mount Kit (JIS), 19", 3U Size for PEL-3021/3041/3111	D129
GRA-418-E	Accessory -- Rack Mount Kit (EIA), 19", 2U Size	D129
GRA-418-J	Accessory -- Rack Mount Kit (JIS), 19", 2U Size	D129
GRA-423	Accessory -- Rack Mount Kit, 19", 2U Size	D129
GRA-424	Accessory -- Rack Mount Kit, 19", 2U Size	D129
GRA-428	Accessory -- Rack Mount Kit (EIA), 19", 3U Size	D129
GRA-429	Accessory -- Rack Mount Kit, 7U Size	D129
GRA-430	Accessory -- Rack Mount Kit, 9U Size	D129
GRA-431-J	Accessory -- Rack Mount Kit (JIS)	D129
GRA-431-E	Accessory -- Rack Mount Kit (EIA)	D129
GRA-439-J	Accessory -- Rack Mount Kit (JIS), 19", 4U Size	D129
GRA-439-E	Accessory -- Rack Mount Kit (EIA), 19", 4U Size	D129
GRA-441-J	Accessory -- Rack Mount Kit (JIS), 19", 4U Size	D129
GRA-441-E	Accessory -- Rack Mount Kit (EIA), 19", 4U Size	D129
GRA-442-J	Accessory -- Rack Mount Kit (JIS), 19", 4U Size	D129
GRA-442-E	Accessory -- Rack Mount Kit (EIA), 19", 4U Size	D129
GRA-449-J	Accessory -- Rack Mount Kit (JIS), 19", 3U Size	D129
GRA-449-E	Accessory -- Rack Mount Kit (EIA), 19", 4U Size	D129
GRJ-1101	Accessory -- Module Cable (0.5m)	D129
GRM-001	Accessory -- Slide Bracket 2pcs/set	D129
GS		
GSM-20H10	Source Measure Unit	D39
GT		
GTL-104A	Accessory -- Test Lead, U-type to Alligator Test Lead, Max. Current 10A, 1000mm	D129
GTL-120	Accessory -- Test Lead, O-type to O-type Test Lead, Max. 40A, 1200mm	D129
GTL-121	Accessory -- Sense Lead, O-type to free Lead, 1200mm	D129
GTL-122	Accessory -- Test Lead, U-type to Alligator Test Lead, Max. Current 40A, 1200mm	D129
GTL-123	Accessory -- Test Lead, O-type to O-type Test Lead, 1200mm	D129
GTL-130	Accessory -- Test Leads: 2 x red, 2 x Black, for 250V/800V Models, 1200mm	D129
GTL-134	Accessory -- Test Leads for Rear Panel, 1200mm, 10A, 16 AWG	D129
GTL-137	Accessory -- Output Power wire(load wire_10AWG:50A, 600V/sense wire_16AWG:20A, 600V)	D129
GTL-202	Accessory -- Sense Lead, Banana to Banana Lead, European Terminal, 200mm	D129
GTL-203A	Accessory -- Test Lead, Banana to Alligator, European Terminal, Max. Current 3A, 1000mm	D129
GTL-204A	Accessory -- Test Lead, Banana to Alligator, European Terminal, Max. Current 10A, 1000mm	D129
GTL-218	Accessory -- Test Lead, O-type to O-type Test Lead, Max. 200A, 1500mm	D129
GTL-219	Accessory -- Test Lead, O-type to O-type Test Lead, Max. 200A, 3000mm	D129
GTL-220	Accessory -- Test Lead, O-type to O-type Test Lead, Max. 300A, 1500mm	D129
GTL-221	Accessory -- Test Lead, O-type to O-type Test Lead, Max. 300A, 3000mm	D129
GTL-222	Accessory -- Test Lead, O-type to O-type Test Lead, Max. 400A, 1500mm	D129
GTL-223	Accessory -- Test Lead, O-type to O-type Test Lead, Max. 400A, 3000mm	D129
GTL-232	Accessory -- RS-232C Cable, 9-pin, F-F Type, Null Modem, 2000mm	D129
GTL-238	Accessory -- RS-232 Cable, 9-pin, M-F type, 1000mm	D129
GTL-240	Accessory -- USB Cable, USB 2.0, A-B type (L type), 1200mm	D129
GTL-246	Accessory -- USB Cable, USB 2.0, A-B type, 1200mm	D129
GTL-248	Accessory -- GPIB Cable, Double Shielded, 2000mm	D129

Model Number Index

GTL-249	Accessory – Frame Link Cable, 300mm	D129
GTL-255	Accessory – Frame Link Cable, 300mm	D129
GTL-258	Accessory – GPIB Cable, 25 pins Micro-D Connector	D129
GTL-259	Accessory – RS-232 Cable with DB9 connector to RJ45	D129
GTL-260	Accessory – RS-485 Cable with DB9 connector to RJ45	D129
GTL-261	Accessory – Serial Master Cable+Terminator, 0.5M	D129
GTL-262	Accessory – RS-485 Slave cable	D129
GU		
GUG-001	Accessory – GPIB-USB Adaptor, GPIB to USB Adaptor	D129
GUR-001A	Accessory – RS232-USB Cable, 300mm	D129
GUR-001B	Accessory – RS-232 to USB Adapter with #4-40 UNC Rivet Nut	D129
PE		
PEL-001	Accessory – GPIB Card	D105
PEL-002	Accessory – Rack Mount Kit, PEL-2000 Series	D105
PEL-003	Accessory – Panel Cover	D105
PEL-004	Accessory – GPIB Card	D129
PEL-005	Accessory – Connect Cu Plate	D129
PEL-006	Accessory – Connect Cu Plate	D129
PEL-007	Accessory – Connect Cu Plate	D129
PEL-008	Accessory – Connect Cu Plate	D129
PEL-009	Accessory – Connect Cu Plate	D129
PEL-010	Accessory – Dust Filter	D129
PEL-011	Accessory – Load Input Terminal Cover	D129
PEL-012	Accessory – Terminal Fittings Kits	D129
PEL-013	Accessory – Flexible Terminal Cover	D129
PEL-014	Accessory – J1/J2 Protection Plug	D129
PEL-016	Accessory – LAN Card	D105
PEL-018	Accessory – LAN Card	D129
PEL-022	Accessory – GPIB Card	D110
PEL-023	Accessory – RS-232 Card	D110
PEL-024	Accessory – LAN Card	D110
PEL-025	Accessory – USB Card	D110
PEL-026	Accessory – Hook Ring	D110
PEL-027-1-4	Accessory – Rack Mount Kit	D110
PEL-028	Accessory – HANDLES, U-shaped Handle(Fixed to the Bracket)	D110
PEL-029	Accessory – HANDLES, Rack Accessories	D124
PEL-030	Accessory – GPIB+RS-232 Card	D111
PEL-031	Accessory – Rack Mount Kit	D125
PEL-032	Accessory – 9923 Current Waveform Generator + RS232 Interface	D125
PEL-503-80-50	80V/50A/250W DC Electronic Load	D117
PEL-504-80-70	80V/70A/350W DC Electronic Load	D117
PEL-504-500-15	500V/15A/350W DC Electronic Load	D117
PEL-507-80-140	80V/140A/700W DC Electronic Load	D117
PEL-507-500-30	500V/30A/700W DC Electronic Load	D117
PEL-2002A(B)	2-Slot Programmable D.C. Electronic Load Mainframe	D105
PEL-2004A(B)	4-Slot Programmable D.C. Electronic Load Mainframe	D105
PEL-2020A(B)	200W, Dual Channel D.C. Electronic Load Module, (1–80V, 20A, 100W) x 2	D105
PEL-2030A(B)	200W, Dual Channel D.C. Electronic Load Module, (1–80V, 5A, 30W) & (1–80V, 40A, 250W)	D105
PEL-2040A(B)	350W, Single Channel D.C. Electronic Load Module, (1–80V, 70A, 350W)	D105
PEL-2041A(B)	350W, Single Channel D.C. Electronic Load Module, (2.5–500V, 10A, 350W)	D105
PEL-3021	175W Programmable D.C. Electronic Load	D93
PEL-3041	350W Programmable D.C. Electronic Load	D93
PEL-3111	1050W Programmable D.C. Electronic Load	D93
PEL-3211	2100W Booster Unit for PEL-3111 only	D93
PEL-3212	2100W Programmable D.C. Electronic Load	D93
PEL-3322	3150W Programmable D.C. Electronic Load	D93
PEL-3323	3150W Programmable D.C. Electronic Load	D93
PEL-3424	4200W Programmable D.C. Electronic Load	D93
PEL-3533	5250W Programmable D.C. Electronic Load	D93
PEL-3535	5250W Programmable D.C. Electronic Load	D93
PEL-3744	7350W Programmable D.C. Electronic Load	D93
PEL-3955	9450W Programmable D.C. Electronic Load	D93
PEL-3021H	175W Programmable D.C. Electronic Load	D93
PEL-3041H	350W Programmable D.C. Electronic Load	D93
PEL-3111H	1050W Programmable D.C. Electronic Load	D93
PEL-3211H	2100W Booster Unit for PEL-3111 only	D93
PEL-3212H	2100W Programmable D.C. Electronic Load	D93
PEL-3322H	3150W Programmable D.C. Electronic Load	D93
PEL-3323H	3150W Programmable D.C. Electronic Load	D93
PEL-3424H	4200W Programmable D.C. Electronic Load	D93
PEL-3533H	5250W Programmable D.C. Electronic Load	D93
PEL-3535H	5250W Programmable D.C. Electronic Load	D93
PEL-3744H	7350W Programmable D.C. Electronic Load	D93
PEL-3955H	9450W Programmable D.C. Electronic Load	D93
PEL-3031E	150V/60A/300W Programmable Single-channel D.C. Electronic Load	D99
PEL-3032E	500V/15A/300W Programmable Single-channel D.C. Electronic Load	D99
PEL-5006C-150-600	150V/600A/6kW High Power DC Electronic Load	D109

PEL-5008C-150-800	150V/800A/8kW High Power DC Electronic Load	D109
PEL-5010C-150-1000	150V/1000A/10kW High Power DC Electronic Load	D109
PEL-5012C-150-1200	150V/1200A/12kW High Power DC Electronic Load	D109
PEL-5015C-150-1500	150V/1500A/15kW High Power DC Electronic Load	D109
PEL-5018C-150-1800	150V/1800A/18kW High Power DC Electronic Load	D109
PEL-5020C-150-2000	150V/2000A/20kW High Power DC Electronic Load	D109
PEL-5024C-150-2000	150V/2000A/24kW High Power DC Electronic Load	D109
PEL-5006C-600-420	600V/420A/6kW High Power DC Electronic Load	D109
PEL-5008C-600-560	600V/560A/8kW High Power DC Electronic Load	D109
PEL-5010C-600-700	600V/700A/10kW High Power DC Electronic Load	D109
PEL-5012C-600-840	600V/840A/12kW High Power DC Electronic Load	D109
PEL-5015C-600-1050	600V/1050A/15kW High Power DC Electronic Load	D109
PEL-5018C-600-1260	600V/1260A/18kW High Power DC Electronic Load	D109
PEL-5020C-600-1400	600V/1400A/20kW High Power DC Electronic Load	D109
PEL-5024C-600-1680	600V/1680A/24kW High Power DC Electronic Load	D109
PEL-5006C-1200-240	1200V/240A/6kW High Power DC Electronic Load	D109
PEL-5008C-1200-320	1200V/320A/8kW High Power DC Electronic Load	D109
PEL-5010C-1200-400	1200V/400A/10kW High Power DC Electronic Load	D109
PEL-5012C-1200-480	1200V/480A/12kW High Power DC Electronic Load	D109
PEL-5015C-1200-600	1200V/600A/15kW High Power DC Electronic Load	D109
PEL-5018C-1200-720	1200V/720A/18kW High Power DC Electronic Load	D109
PEL-5020C-1200-800	1200V/800A/20kW High Power DC Electronic Load	D109
PEL-5024C-1200-960	1200V/960A/24kW High Power DC Electronic Load	D109
PEL-5004G-150-400	150V/400A/4000kW High Power DC Electronic Load	D125
PEL-5005G-150-500	150V/500A/5000kW High Power DC Electronic Load	D125
PEL-5006G-150-600	150V/600A/6000kW High Power DC Electronic Load	D125
PEL-5004G-600-280	600V/280A/4000kW High Power DC Electronic Load	D125
PEL-5005G-600-350	600V/350A/5000kW High Power DC Electronic Load	D125
PEL-5006G-600-420	600V/420A/6000kW High Power DC Electronic Load	D125
PEL-5004G-1200-160	1200V/160A/4000kW High Power DC Electronic Load	D125
PEL-5005G-1200-200	1200V/200A/5000kW High Power DC Electronic Load	D125
PEL-5006G-1200-240	1200V/240A/6000kW High Power DC Electronic Load	D125

PF		
PFR-100M	Fanless Multi-range D.C. Power Supply	D27
PFR-100L	Fanless Multi-range D.C. Power Supply	D27

PP		
PPE-3323	207W, 3-Channel, Programmable Linear D.C. Power Supply	D61
PPH-1503	45W Programmable High Precision Linear D.C. Power Supply	D43
PPH-1503D	45W/18W Programmable High Precision Linear D.C. Power Supply	D43
PPH-1506D	45W/36W Programmable High Precision Linear D.C. Power Supply	D43
PPH-1510D	45W/36W Programmable High Precision Linear D.C. Power Supply	D43
PPT-1830	138W, 3-Channel, Programmable Linear D.C. Power Supply	D62
PPT-3615	126W, 3-Channel, Programmable Linear D.C. Power Supply	D62
PPX-1005	10V/5A/50W Programmable High-precision DC Power Supply	D47
PPX-2002	20V/2A/40W Programmable High-precision DC Power Supply	D47
PPX-2005	20V/5A/100W Programmable High-precision DC Power Supply	D47
PPX-3601	36V/1A/36W Programmable High-precision DC Power Supply	D47
PPX-3603	36V/3A/108W Programmable High-precision DC Power Supply	D47
PPX-10H01	100V/1A/100W Programmable High-precision DC Power Supply	D47
PPX-G	Accessory – GPIB Interface(Factory Installed)	D47

PS		
PSB-001	Accessory – GPIB Card	D29
PSB-003	Accessory – Parallel Connection kit (for horizontal installation), Kit includes: (PSB-007 Joint Kit, Horizontal bus bar x 2 , PSB-005 x1)	D29
PSB-004	Accessory – Parallel Connection kit (for vertical installation) Kit includes:(PSB-007 Joint Kit, Vertical bus bar x 2, PSB-005x1)	D29
PSB-005	Accessory – Parallel Connection Signal Cable	D29
PSB-006	Accessory – Serial Connection Signal Cable	D29
PSB-007	Accessory – Joint Kit: Includes 4 Joining plates, [M3x6]screws x 4 ; [M3x8]screw x 2	D29
PSB-008	Accessory – RS232C Cable (PSB-2000 Only)	D29
PSB-101	Accessory – Cable for 2 units	D33
PSB-102	Accessory – Cable for 3 units	D33
PSB-103	Accessory – Cable for 4 units	D33
PSB-104	Accessory – Cable for 2 units	D33
PSB-105	Accessory – GPIB Card	D33
PSB-106	Accessory – Basic Accessory Kit	D33
PSB-1400L	40V/40A/400W Programmable Multi-Range D.C. Power Supply	D33
PSB-1400M	160V/10A/400W Programmable Multi-Range D.C. Power Supply	D33
PSB-1800L	40V/80A/800W Programmable Multi-Range D.C. Power Supply	D33
PSB-1800M	160V/20A/800W Programmable Multi-Range D.C. Power Supply	D33
PSB-2400H	400W Multi-Range Programmable Switching D.C. Power Supply	D29
PSB-2400L	400W Multi-Range Programmable Switching D.C. Power Supply	D29
PSB-2400L2	800W Multi-Range, 2-Channel, Programmable Switching D.C. Power Supply	D29
PSB-2800H	800W Multi-Range Programmable Switching D.C. Power Supply	D29
PSB-2800L	800W Multi-Range Programmable Switching D.C. Power Supply	D29
PSB-2800LS	800W Slave (Booster) Unit For Current Extension Only	D29
PSH-2018A	360W Programmable Switching D.C. Power Supply	D35
PSH-3610A	360W Programmable Switching D.C. Power Supply	D35
PSH-3620A	720W Programmable Switching D.C. Power Supply	D35
PSH-3630A	1080W Programmable Switching D.C. Power Supply	D35

PSM-2010	200W Programmable Dual-Range Linear D.C. Power Supply	D59
PSM-3004	120W Programmable Dual-Range Linear D.C. Power Supply	D59
PSM-6003	200W Programmable Dual-Range Linear D.C. Power Supply	D59
PSP-2010	200W Programmable Switching D.C. Power Supply	D36
PSP-405	200W Programmable Switching D.C. Power Supply	D36
PSP-603	200W Programmable Switching D.C. Power Supply	D36
PSS-2005	100W Programmable Linear D.C. Power Supply	D60
PSS-3203	96W Programmable Linear D.C. Power Supply	D60
PST-3201	96W Triple Output Programmable D.C. Power Supply	D63
PST-3202	158W Triple Output Programmable D.C. Power Supply	D63
PSU 6-200	1200W Programmable Switching DC Power Supply	D19
PSU 8-180	1440W Programmable Switching DC Power Supply	D19
PSU 12.5-120	1500W Programmable Switching DC Power Supply	D19
PSU 15-100	1500W Programmable Switching DC Power Supply	D19
PSU 20-76	1520W Programmable Switching DC Power Supply	D19
PSU 30-50	1500W Programmable Switching DC Power Supply	D19
PSU 40-38	1520W Programmable Switching DC Power Supply	D19
PSU 50-30	1500W Programmable Switching DC Power Supply	D19
PSU 60-25	1500W Programmable Switching DC Power Supply	D19
PSU 80-19	1520W Programmable Switching DC Power Supply	D19
PSU 100-15	1500W Programmable Switching DC Power Supply	D19
PSU 150-10	1500W Programmable Switching DC Power Supply	D19
PSU 300-5	1500W Programmable Switching DC Power Supply	D19
PSU 400-3.8	1520W Programmable Switching DC Power Supply	D19
PSU 600-2.6	1560W Programmable Switching DC Power Supply	D19
PSU-001	Accessory -- Front Panel Filter kit(factory Installed)	D19
PSU-01A	Accessory -- Joins a Vertical Stack of 2 PSU Units Together. 2U-Sized Handles x2, Joining Plates x2	D19
PSU-01B	Accessory -- Bus Bar for 2 units in Parallel Operation	D19
PSU-01C	Accessory -- Cable for 2 units in Parallel Operation	D19
PSU-02A	Accessory -- Joins a Vertical Stack of 3 PSU units Together. 3U-sized handles x2, Joining Plates x2	D19
PSU-02B	Accessory -- Bus Bar for 3 units in Parallel Operation	D19
PSU-02C	Accessory -- Cable for 3 units in Parallel Operation	D19
PSU-03A	Accessory -- Joins a Vertical Stack of 4 PSU units Together. 4U-sized Handles x2, Joining Plates x2	D19
PSU-03B	Accessory -- Bus Bar for 4 units in Parallel Operation	D19
PSU-03C	Accessory -- Cable for 4 units in Parallel Operation	D19
PSU-232	Accessory -- RS232 Cable with DB9 Connector kit	D19
PSU-485	Accessory -- RS485 Cable with DB9 Connector kit	D19
PSU-GPIB	Accessory -- PSU GPIB Interface Card (Factory Installed)	D19
PSU-ISO-I	Accessory -- Isolated Current Remote Control Card (Factory Installed)	D19
PSU-ISO-V	Accessory -- Isolated Voltage Remote Control Card (Factory Installed)	D19
PSW160-14.4	720W Multi-Range Programmable Switching D.C. Power Supply	D15
PSW160-21.6	1080W Multi-Range Programmable Switching D.C. Power Supply	D15
PSW160-7.2	360W Multi-Range Programmable Switching D.C. Power Supply	D15
PSW250-13.5	1080W Multi-Range Programmable Switching D.C. Power Supply	D15
PSW250-4.5	360W Multi-Range Programmable Switching D.C. Power Supply	D15
PSW250-9	720W Multi-Range Programmable Switching D.C. Power Supply	D15
PSW30-108	1080W Multi-Range Programmable Switching D.C. Power Supply	D15
PSW30-36	360W Multi-Range Programmable Switching D.C. Power Supply	D15
PSW30-72	720W Multi-Range Programmable Switching D.C. Power Supply	D15
PSW40-27	1080W Multi-Range Programmable Switching D.C. Power Supply	D15
PSW40-54	360W Multi-Range Programmable Switching D.C. Power Supply	D15
PSW40-81	720W Multi-Range Programmable Switching D.C. Power Supply	D15
PSW-720L11	30V/36A*2 720W Multi-Range D.C. Power Supply	D9
PSW-720L12	30V/36A*1 40V/27A*1 720W Multi-Range D.C. Power Supply	D9
PSW-720L14	30V/36A*1 80V/13.5A*1 720W Multi-Range D.C. Power Supply	D9
PSW-720L15	30V/36A*1 160V/7.2A*1 720W Multi-Range D.C. Power Supply	D9
PSW-720L22	40V/27A*2 720W Multi-Range D.C. Power Supply	D9
PSW-720L24	40V/27A*1 80V/13.5A*1 720W Multi-Range D.C. Power Supply	D9
PSW-720L25	40V/27A*1 160V/7.2A*1 720W Multi-Range D.C. Power Supply	D9
PSW-720L44	80V/13.5A*2 720W Multi-Range D.C. Power Supply	D9
PSW-720L45	80V/13.5A*1 160V/7.2A*1 720W Multi-Range D.C. Power Supply	D9
PSW-720L55	160V/7.2A*2 720W Multi-Range D.C. Power Supply	D9
PSW-720H66	250V/4.5A*2 720W Multi-Range D.C. Power Supply	D9
PSW-720H68	250V/4.5A*1 800V/1.44A*1 720W Multi-Range D.C. Power Supply	D9
PSW-720H88	800V/1.44A*2 720W Multi-Range D.C. Power Supply	D9
PSW800-1.44	360W Multi-Range Programmable Switching D.C. Power Supply	D15
PSW800-2.88	720W Multi-Range Programmable Switching D.C. Power Supply	D15
PSW800-4.32	1080W Multi-Range Programmable Switching D.C. Power Supply	D15
PSW80-13.5	360W Multi-Range Programmable Switching D.C. Power Supply	D15
PSW80-27	720W Multi-Range Programmable Switching D.C. Power Supply	D15
PSW80-40.5	1080W Multi-Range Programmable Switching D.C. Power Supply	D15
PSW-1080L111	30V/36A*3 1080W Multi-Range D.C. Power Supply	D9
PSW-1080L112	30V/36A*2 40V/27A*1 1080W Multi-Range D.C. Power Supply	D9
PSW-1080L114	30V/36A*2 80V/13.5A*1 1080W Multi-Range D.C. Power Supply	D9
PSW-1080L115	30V/36A*2 160V/7.2A*1 1080W Multi-Range D.C. Power Supply	D9
PSW-1080L122	30V/36A*1 40V/27A*2 1080W Multi-Range D.C. Power Supply	D9
PSW-1080L124	30V/36A*1 40V/27A*1 80V/13.5A*1 1080W Multi-Range D.C. Power Supply	D9
PSW-1080L125	30V/36A*1 40V/27A*1 160V/7.2A 1080W Multi-Range D.C. Power Supply	D9

PSW-1080L144	30V/36A*1 80V/13.5A*2 1080W Multi-Range D.C. Power supply	D9
PSW-1080L145	30V/36A*1 80V/13.5A*1 160V/7.2A*1 1080W Multi-Range D.C. Power Supply	D9
PSW-1080L155	30V/36A*1 160V/7.2A*2 1080W Multi-Range D.C. Power Supply	D9
PSW-1080L222	40V/27A*3 1080W Multi-Range D.C. Power Supply	D9
PSW-1080L224	40V/27A*2 80V/13.5A*1 1080W Multi-Range D.C. Power Supply	D9
PSW-1080L225	40V/27A*2 160V/7.2A*1 1080W Multi-Range D.C. Power Supply	D9
PSW-1080L244	40V/27A*1 80V/13.5A*2 1080W Multi-Range D.C. Power Supply	D9
PSW-1080L245	40V/27A*1 80V/13.5A*1 160V/7.2A*1 1080W Multi-Range D.C. Power Supply	D9
PSW-1080L255	40V/27A*1 160V/7.2A*2 1080W Multi-Range D.C. Power supply	D9
PSW-1080L444	80V/13.5A*3 1080W Multi-Range D.C. Power supply	D9
PSW-1080L445	80V/13.5A*2 160V/7.2A*1 1080W Multi-Range D.C. Power supply	D9
PSW-1080L455	80V/13.5A*1 160V/7.2A*2 1080W Multi-Range D.C. Power supply	D9
PSW-1080L555	160V/7.2A*3 1080W Multi-Range D.C. Power supply	D9
PSW-1080H666	250V/4.5A*3 1080W Multi-Range D.C. Power Supply	D9
PSW-1080H668	250V/4.5A*2 800V/1.44A*1 1080W Multi-Range D.C. Power Supply	D9
PSW-1080H688	250V/4.5A*1 800V/1.44A*2 1080W Multi-Range D.C. Power Supply	D9
PSW-1080H888	800V/1.44A*3 1080W Multi-Range D.C. Power Supply	D9
PSW-001	Accessory -- Accessory Kits	D15
PSW-002	Accessory -- Simple IDC Tool	D15
PSW-003	Accessory -- Contact Removal Tool	D15
PSW-004	Accessory -- Basic Accessory Kit for 30V/80V/160V Models	D15
PSW-005	Accessory -- Series Operation Cable for 2 units(for 30V/80V/160V)	D15
PSW-006	Accessory -- Parallel Operation Cable for 2 units	D15
PSW-007	Accessory -- Parallel Operation Cable for 3 units	D15
PSW-008	Accessory -- Basic Accessory Kit for 250V/800V Models	D15
PSW-009	Accessory -- Output Terminal Cover for 30V/80V/160V Models	D15
PSW-010	Accessory -- Large Filter (Type II/III)	D15
PSW-011	Accessory -- Output Terminal Cover for 250V/800V Models	D15
PSW-012	Accessory -- High Voltage Output Terminal for 250V/800V Model	D15

SP

SPD-3606	375W, 3-Channel, Programmable Switching D.C. Power Supply	D38
SPS-1230	360W Switching D.C. Power Supply	D37
SPS-1820	360W Switching D.C. Power Supply	D37
SPS-2415	360W Switching D.C. Power Supply	D37
SPS-3610	360W Switching D.C. Power Supply	D37
SPS-606	360W Switching D.C. Power Supply	D37



DC POWER SUPPLIES

Stemming from the design and manufacture demands of electronic industries, GW Instek offers diverse power supply product lines to meet user's demand for a variety of applications. Based on different needs, the product lines can be divided into several categories including DC Power Supply, AC Power Source, DC Electronic Load and Source Measure Unit.

For DC Power Supply, the products can be briefly categorized by the following types, Technic, Programmable or Non-programmable, Single or Multiple Outputs, High Precision or Affordable Price, Dual Range and Wide Combinations of Voltage and Current, which can be selected to meet the application requirements.

Precision source meter is the latest product offering a four-quadrant power supply, which can accurately utilize voltage or current and measure voltage and/or current at the same time.

GW Instek offers more than 100 power supply products, which are suitable for the requirements of Electronic Assembly Testing, Education, Component Testing, Wireless Product Testing, Burn-in, Battery-Power Product Testing Automotive, Aerospace industries and so on.

PRODUCTS

- Programmable & Single Channel DC Power Supply
- Non-Programmable & Single Channel DC Power Supply
- Programmable & Multiple Channel DC Power Supply
- Non-Programmable & Multiple Channel DC Power Supply
- Source Measure Unit

DC POWER SUPPLIES

GENERAL SELECTION GUIDE OF POWER SUPPLY BY APPLICATION

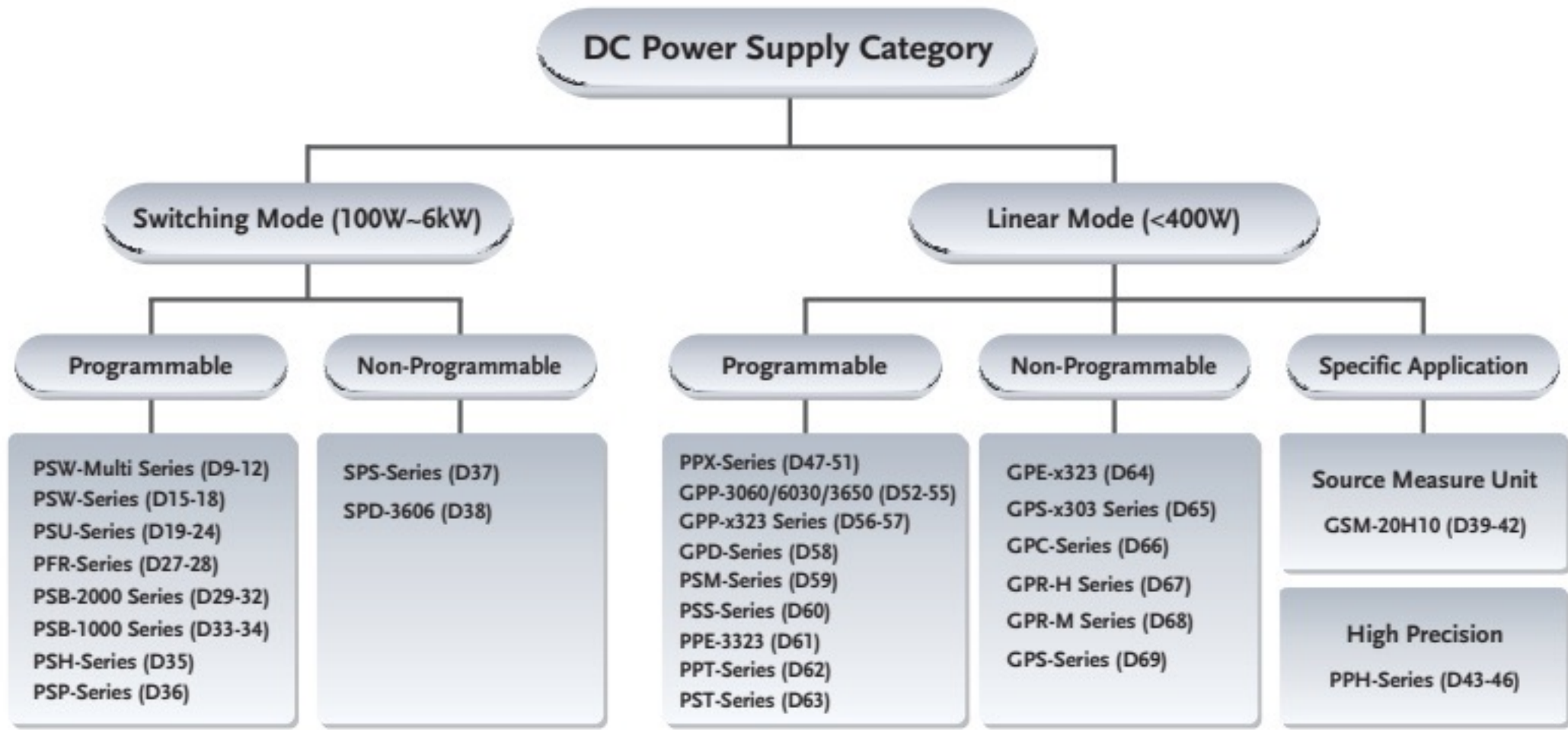

Series	Education	R&D/ Research Lab	Production Testing	ATE for Production	Burn-IN	Page
PSW-Multi Series		✓	✓	✓	✓	D9-12
PSW-Series		✓	✓	✓	✓	D15-18
PSU-Series		✓	✓	✓	✓	D19-24
PFR-Series		✓		✓		D27-28
PSB-2000 Series		✓	✓	✓	✓	D29-32
PSB-1000 Series		✓	✓	✓	✓	D33-34
PSH-Series		✓	✓	✓	✓	D35
PSP-Series	✓	✓		✓		D36
SPS-Series			✓	✓	✓	D37
SPD-3606	✓	✓	✓		✓	D38
GSM-20H10	✓	✓	✓	✓		D39-42
PPH-Series		✓	✓		✓	D43-46
PPX-Series		✓	✓		✓	D47-51
GPP-3060/6030/3650		✓	✓	✓	✓	D52-55
GPP-x323 Series	✓	✓	✓		✓	D56-57
GPD-Series	✓	✓	✓			D58
PSM-Series		✓	✓		✓	D59
PSS-Series		✓	✓	✓		D60
PPE-3323	✓	✓	✓	✓		D61
PPT-Series	✓	✓	✓	✓		D62
PST-Series	✓	✓	✓	✓		D63
GPE-x323	✓	✓	✓			D64
GPS-x303 Series	✓	✓	✓			D65
GPC-Series	✓	✓	✓			D66
GPR-H Series		✓	✓		✓	D67
GPR-M Series		✓	✓		✓	D68
GPS-Series	✓	✓	✓			D69

DC POWER SUPPLIES

GENERAL SELECTION GUIDE OF DC POWER SUPPLY BY TECHNIC

Technic	Channel	Programmability	Display	Model Series	Page	
Switching	2, 3	Programmable	LED	PSW-Multi Series	D9-12	
	1		LED	PSW-Series	D15-18	
	1		LED	PSU-Series	D19-24	
	1		LED	PFR-Series	D25-28	
	1		LED	PSB-2400L/PSB-2800L/PSB-2400H/PSB-2800H/PSB-2800LS	D29-32	
	1		LCD	PSB-1000 Series	D33-34	
	1		LCD	PSH-Series	D35	
	1		LCD	PSP-Series	D36	
	1		Non-Programmable	LED	SPS-Series	D37
	2	Programmable	LED	PSB-2400L2	D29-32	
	3	Non-Programmable	LED	SPD-3606	D38	
	Linear	1	Programmable	LCD	PPH-1503	D43-46
		1		LCD	GSM-20H10	D39-42
1		LED		GPP-1326	D56-57	
1		LCD		PPX-Series	D47-51	
1		VFD		PSM-Series	D59	
1		LCD		PSS-Series	D60	
1		Non-Programmable	LED	GPR-H Series	D67	
1			LED	GPR-M Series	D68	
1			LED	GPS-1830D/GPS-1850D/GPS-3030D/GPS-3030DD	D69	
1			LED	GPE-1326	D64	
2		Programmable	LCD	PPH-1503D/PPH-1506D/PPH-1510D	D43-46	
3			LCD	GPP-3060/GPP-6030	D52-55	
2			LCD	GPP-2323	D56-57	
3				GPP-3323		
4				GPP-4323		
2			LED	GPD-2303S	D58	
3				GPD-3303S		
4				GPD-4303S		
3				PPE-3323		
3			LED	PPT-Series	D62	
3			LED	PST-3201	D63	
3			LED	PST-3202		
2			Non-Programmable	LED	GPE-2323	D64
3					GPE-3323	
4		GPE-4323				
2		LED		GPS-2303	D65	
3				GPS-3303		
4	GPS-4303					
3	LED	GPC-Series	D66			

DC POWER SUPPLIES

GENERAL SELECTION GUIDE OF DC POWER SUPPLY BY CHANNEL

Channel	Programmability	Technic	Display	Model Series	Page
Single Channel	Programmable	Switching	LED	PSW-Series	D15-18
			LED	PSU-Series	D19-24
			LED	PFR-Series	D25-28
			LED	PSB-2400L/PSB-2800L/PSB-2400H/PSB-2800H/PSB-2800LS	D29-32
			LCD	PSB-1000 Series	D33-34
			LCD	PSH-Series	D35
		LCD	PSP-Series	D36	
		Linear	LCD	PPH-1503	D43-46
			LCD	GSM-20H10	D39-42
			LED	GPP-1326	D56-57
			LCD	PPX-Series	D47-51
	VFD		PSM-Series	D59	
	Non-Programmable	Switching	LCD	PSS-Series	D60
			LED	SPS-Series	D37
Linear		LED	GPE-1326	D64	
		LED	GPR-H Series	D67	
		LED	GPR-M Series	D68	
		LED	GPS-1830D/GPS-1850D/GPS-3030D/GPS-3030DD	D69	
		LED	GPD-Series	D58	
Multiple Channel	Programmable	Switching	LED	PSB-2400L2	D29-32
			LED	PSW-Multi Series	D9-12
		Linear	LCD	PPH-1503D/PPH-1506D/PPH-1510D	D43-46
			LCD	GPP-3060/GPP-6030	D52-55
			LCD	GPP-2323/GPP-3323/GPP-4323	D56-57
			LED	GPD-Series	D58
			LED	PPE-3323	D61
			LED	PPT-Series	D62
			LED	PST-3201	D63
			LED	PST-3202	D63
	Non-Programmable	Switching	LED	SPD-3606	D38
		Linear	LED	GPE-2323/GPE-3323/GPE-4323	D64
			LED	GPS-x303 Series	D65
LED	GPC-Series	D66			

DC POWER SUPPLIES

PROGRAMMABLE & SINGLE CHANNEL DC POWER SUPPLY

Voltage(V)	Current(A)	Total Power(W)	Model Name	Display	Technic	Interface	Page
6	200	1200	PSU 6-200	LED	Switching	RS-232, RS-485, USB, LAN, Analog Control, (Opt)GPIB	D19-24
8	180	1440	PSU 8-180	LED	Switching	RS-232, RS-485, USB, LAN, Analog Control, (Opt)GPIB	
15	100	1500	PSU 15-100	LED	Switching	RS-232, RS-485, USB, LAN, Analog Control, (Opt)GPIB	
30	50	1500	PSU 30-50	LED	Switching	RS-232, RS-485, USB, LAN, Analog Control, (Opt)GPIB	
50	30	1500	PSU 50-30	LED	Switching	RS-232, RS-485, USB, LAN, Analog Control, (Opt)GPIB	
80	19	1520	PSU 80-19	LED	Switching	RS-232, RS-485, USB, LAN, Analog Control, (Opt)GPIB	
8	20	200	PSM-2010	VFD	Linear	RS-232, (Opt)GPIB	D59
9	5	45	PPH-1503	LCD	Linear	USBCDC, LAN, GPIB	D43-46
10	5	50	PPX-1005	LCD	Linear	USBCDC, LAN, RS-232, RS-485, (Opt)GPIB	D47-51
12.5	120	1500	PSU 12.5-120	LED	Switching	RS-232, RS-485, USB, LAN, Analog Control, (Opt)GPIB	D19-24
15	3	45	PPH-1503	LCD	Linear	USBCDC, LAN, GPIB	D43-46
15	7	120	PSM-3004	VFD	Linear	RS-232, (Opt)GPIB	D59
20	1	20	GSM-20H10	LCD	Linear	RS-232, USBTMC, LAN, GPIB	D39-42
20	2	40	PPX-2002	LCD	Linear	USBCDC, LAN, RS-232, RS-485, (Opt)GPIB	D47-51
20	5	100	PPX-2005	LCD	Linear	USBCDC, LAN, RS-232, RS-485, (Opt)GPIB	
20	5	100	PSS-2005	LCD	Linear	RS-232, (Opt)GPIB	
20	10	200	PSP-2010	LCD	Switching	RS-232	D36
20	10	200	PSM-2010	VFD	Linear	RS-232, (Opt)GPIB	D59
20	18	360	PSH-2018A	LCD	Switching	RS-232, (Opt)GPIB	D35
20	76	1520	PSU 20-76	LED	Switching	RS-232, RS-485, USB, LAN, Analog Control, (Opt)GPIB	D19-24
30	4	120	PSM-3004	VFD	Linear	RS-232, (Opt)GPIB	D59
30	6	200	PSM-6003	VFD	Linear	RS-232, (Opt)GPIB	
30	36	360	PSW 30-36	LED	Switching	LAN, USB, Analog Control, (Opt)GPIB, RS-232	D15-18
30	72	720	PSW 30-72	LED	Switching	LAN, USB, Analog Control, (Opt)GPIB, RS-232	
30	108	1080	PSW 30-108	LED	Switching	LAN, USB, Analog Control, (Opt)GPIB, RS-232	
32	3	96	PSS-3203	LCD	Linear	RS-232, (Opt)GPIB	D60
32	6	192	GPP-1326	LCD	Linear	USBCDC, RS-232, (Opt)LAN, GPIB	D56-57
36	1	36	PPX-3601	LCD	Linear	USBCDC, LAN, RS-232, RS-485, (Opt)GPIB	D47-51
36	3	108	PPX-3603	LCD	Linear	USBCDC, LAN, RS-232, RS-485, (Opt)GPIB	
36	10	360	PSH-3610A	LCD	Switching	RS-232, (Opt)GPIB	D35
36	20	720	PSH-3620A	LCD	Switching	RS-232, (Opt)GPIB	
36	30	1080	PSH-3630A	LCD	Switching	RS-232, (Opt)GPIB	
40	27	360	PSW 40-27	LED	Switching	LAN, USB, Analog Control, (Opt)GPIB, RS-232	D15-18
40	54	720	PSW 40-54	LED	Switching	LAN, USB, Analog Control, (Opt)GPIB, RS-232	
40	81	1080	PSW 40-81	LED	Switching	LAN, USB, Analog Control, (Opt)GPIB, RS-232	
40	5	200	PSP-405	LCD	Switching	RS-232	D36
40	38	1520	PSU 40-38	LED	Switching	RS-232, RS-485, USB, LAN, Analog Control, (Opt)GPIB	D19-24
40	40	400	PSB-1400L	LCD	Switching	LAN, USBCDC, Analog Control, (Opt)GPIB	D33-34
40	80	800	PSB-1800L	LCD	Switching	LAN, USBCDC, Analog Control, (Opt)GPIB	
50	10	100	PFR-100L	LED	Switching	RS-232, RS-485, USB, LAN, (Opt)GPIB	D25-28
60	3.3	200	PSM-6003	VFD	Linear	RS-232, (Opt)GPIB	D59
60	3.5	200	PSP-603	LCD	Switching	RS-232	D36
60	25	1500	PSU 60-25	LED	Switching	RS-232, RS-485, USBCDC, LAN, Analog Control, (Opt)GPIB	D19-24
80	13.5	360	PSW 80-13.5	LED	Switching	LAN, USBCDC, Analog Control, (Opt)GPIB, RS-232	D15-18
80	27	720	PSW 80-27	LED	Switching	LAN, USBCDC, Analog Control, (Opt)GPIB, RS-232	
80	40	400	PSB-2400L	LED	Switching	USBCDC, Analog Control, (Opt)GPIB, RS-232	D29-32
80	40.5	1080	PSW 80-40.5	LED	Switching	LAN, USBCDC, Analog Control, (Opt)GPIB	D15-18
80	80	800	PSB-2800L	LED	Switching	RS-232, USBCDC, Analog Control, (Opt)GPIB	D29-32
80	80	800	PSB-2800LS	LED	Switching	RS-232, USBCDC, Analog Control, (Opt)GPIB	
100	1	100	PPX-10H01	LCD	Linear	USBCDC, LAN, RS-232, RS-485, (Opt)GPIB	D47-51
100	15	1500	PSU 100-15	LED	Switching	RS-232, RS-485, USBCDC, LAN, Analog Control, (Opt)GPIB	D19-24
150	10	1500	PSU 150-10	LED	Switching	RS-232, RS-485, USBCDC, LAN, Analog Control, (Opt)GPIB	
160	7.2	360	PSW 160-7.2	LED	Switching	LAN, USBCDC, Analog Control, (Opt)GPIB, RS-232	D15-18

DC POWER SUPPLIES

Voltage(V)	Current(A)	Total Power(W)	Model Name	Display	Technic	Interface	Page
160	10	400	PSB-1400M	LCD	Switching	LAN, USB CDC, Analog Control, (Opt) GPIB, RS-232	D33-34
160	14.4	720	PSW 160-14.4	LED	Switching	LAN, USB CDC, Analog Control, (Opt) GPIB, RS-232	D15-18
160	20	800	PSB-1800M	LCD	Switching	LAN, USB CDC, Analog Control, (Opt) GPIB	D33-34
160	21.6	1080	PSW 160-21.6	LED	Switching	LAN, USB CDC, Analog Control, (Opt) GPIB	D15-18
200	0.1	20	GSM-20H10	LCD	Linear	RS-232, USB TMC, LAN, GPIB	D39-42
250	2	100	PFR-100M	LED	Switching	RS-232, RS-485, USB CDC, LAN, (Opt) GPIB, RS-232	D25-28
250	4.5	360	PSW 250-4.5	LED	Switching	LAN, USB CDC, Analog Control, (Opt) GPIB, RS-232	D15-18
250	9	720	PSW 250-9	LED	Switching	LAN, USB CDC, Analog Control, (Opt) GPIB, RS-232	
250	13.5	1080	PSW 250-13.5	LED	Switching	LAN, USB CDC, Analog Control, (Opt) GPIB, RS-232	
300	5	1500	PSU 300-5	LED	Switching	RS-232, RS-485, USB CDC, LAN, Analog Control, (Opt) GPIB	D19-24
400	3.8	1520	PSU 400-3.8	LED	Switching	RS-232, RS-485, USB CDC, LAN, Analog Control, (Opt) GPIB	
600	2.6	1560	PSU 600-2.6	LED	Switching	RS-232, RS-485, USB CDC, LAN, Analog Control, (Opt) GPIB	
800	1.44	360	PSW 800-1.44	LED	Switching	LAN, USB CDC, Analog Control, (Opt) GPIB, RS-232	D15-18
800	2.88	720	PSW 800-2.88	LED	Switching	LAN, USB CDC, Analog Control, (Opt) GPIB, RS-232	
800	3	400	PSB-2400H	LED	Switching	RS-232, USB CDC, Analog Control, (Opt) GPIB	D29-32
800	4.32	1080	PSW 800-4.32	LED	Switching	LAN, USB CDC, Analog Control, (Opt) GPIB, RS-232	D15-18
800	6	800	PSB-2800H	LED	Switching	RS-232, USB CDC, Analog Control, (Opt) GPIB	D29-32

NON-PROGRAMMABLE & SINGLE CHANNEL DC POWER SUPPLY

Voltage(V)	Current(A)	Total Power(W)	Model Name	Display	Technic	Remark	Page
8	30	240	GPR-0830HD	LED	Linear	Rear-Panel Output	D67
12	30	360	SPS-1230	LED	Switching	Rear-Panel Output	D37
18	3	54	GPS-1830D	LED	Linear	Rear-Panel Output	D69
18	5	90	GPS-1850D	LED	Linear		
18	10	180	GPR-1810HD	LED	Linear	Rear-Panel Output	D68
18	20	360	SPS-1820	LED	Switching	Rear-Panel Output	D37
18	20	360	GPR-1820HD	LED	Linear	Rear-Panel Output	D67
24	15	360	SPS-2415	LED	Switching		D37
30	3	90	GPS-3030D	LED	Linear	Rear-Panel Output	D69
30	3	90	GPS-3030DD	LED	Linear		
30	6	180	GPR-3060D	LED	Linear	Rear-Panel Output	D68
32	6	192	GPE-1326	LED	Linear	Rear-Panel Output	D64
35	10	350	GPR-3510HD	LED	Linear	Rear-Panel Output	D67
36	10	360	SPS-3610	LED	Switching	Rear-Panel Output	D37
60	3	180	GPR-6030D	LED	Linear	Rear-Panel Output	D68
60	6	360	SPS-606	LED	Switching	Rear-Panel Output	D37
60	6	360	GPR-6060D	LED	Linear	Rear-Panel Output	D67
75	5	375	GPR-7550D	LED	Linear	Rear-Panel Output	
110	3	330	GPR-11H30D	LED	Linear	Rear-Panel Output	
300	1	300	GPR-30H10D	LED	Linear	Rear-Panel Output	

DC POWER SUPPLIES

PROGRAMMABLE & MULTIPLE CHANNEL DC POWER SUPPLY

	Voltage(V)	Current(A)	Power per. CH	Total Power(W)	Model Name	Channel	Display	Technic	Interface	Page
CH1	15	3	45	63	PPH-1503D	2	LCD	Linear	USBTMC, LAN, GPIB	D43-46
	9	5	45							
CH2	12	1.5	18	81	PPH-1506D	2	LCD	Linear	USBTMC, LAN, GPIB	
CH1	15	3	45							
CH2	12	3	36	81	PPH-1510D	2	LCD	Linear	USBTMC, LAN, GPIB	
CH1	9	5	45							
	4.5	10	45	138	PPT-1830	3	LED	Linear	GPIB	
CH2	12	3	36							
CH1	18	3	54	385	GPP-3060	3	LCD	Linear	USBCDC, RS-232, (Opt)LAN, GPIB	
CH2	18	3	54							
CH3	6	5	30	180	GPD-2303S	2	LED	Linear	USBCDC	
CH1	30	6	180							
CH2	30	6	180	195	GPD-3303S	3	LED	Linear	USBCDC	
CH3	1.8/2.5/3.3/5.0	5	25							
CH1	30	3	90	195	GPD-4303S	4	LED	Linear	USBCDC	
CH2	30	3	90							
CH1	30	3	90	195	GPD-3303D	3	LED	Linear	USBCDC	
CH2	30	3	90							
CH3	2.5/3.3/5.0	3	15	192	GPP-2323	2	LCD	Linear	USBCDC, RS-232, (Opt)LAN, GPIB	
CH1	30	3	90							
CH2	30	3	90	217	GPP-3323	3	LCD	Linear	USBCDC, RS-232, (Opt)LAN, GPIB	
CH3	1.8/2.5/3.3/5.0	5	25							
CH1	32	3	96	212	GPP-4323	4	LCD	Linear	USBCDC, RS-232, (Opt)LAN, GPIB	
CH2	32	3	96							
CH3	5	1	5	207	PPE-3323	3	LED	Linear	RS-232	
CH4	15	1	15							
CH1	32	3	96	126	PPT-3615	3	LED	Linear	GPIB	
CH2	32	3	96							
CH3	3.3 / 5	3	15	158	PST-3202	3	LED	Linear	RS-232(O), GPIB	
CH1	36	1.5	54							
CH2	36	1.5	54	96	PST-3201	3	LED	Linear	RS-232(O), GPIB	
CH3	6	5	30							
CH1	32	1	32	385	GPP-6030	3	LCD	Linear	USBCDC, RS-232, (Opt)LAN, GPIB	
CH2	32	1	32							
CH3	32	1	32	800	PSB-2400L2	2	LED	Switching	RS-232, USB, Analog Control,	
CH1	60	3	180							
CH2	60	3	180	720	PSW-720L11	2	LED	Switching	LAN, USB, Analog Control, (Opt)GPIB, RS-232	
CH3	1.8/2.5/3.3/5.0	5	25							
CH1	80	40	400	720	PSW-720L12	2	LED	Switching	LAN, USB, Analog Control, (Opt)GPIB, RS-232	
CH2	80	40	400							
CH1	30	36	360	720	PSW-720L14	2	LED	Switching	LAN, USB, Analog Control, (Opt)GPIB, RS-232	
CH2	30	36	360							
CH1	30	36	360	720	PSW-720L15	2	LED	Switching	LAN, USB, Analog Control, (Opt)GPIB, RS-232	
CH2	80	13.5	360							
CH1	30	36	360	720	PSW-720L22	2	LED	Switching	LAN, USB, Analog Control, (Opt)GPIB, RS-232	
CH2	160	7.2	360							
CH1	40	27	360	720	PSW-720L24	2	LED	Switching	LAN, USB, Analog Control, (Opt)GPIB, RS-232	
CH2	40	27	360							
CH1	40	27	360	720	PSW-720L25	2	LED	Switching	LAN, USB, Analog Control, (Opt)GPIB, RS-232	
CH2	80	13.5	360							
CH1	40	27	360	720	PSW-720L44	2	LED	Switching	LAN, USB, Analog Control, (Opt)GPIB, RS-232	
CH2	160	7.2	360							
CH1	80	13.5	360	720	PSW-720L45	2	LED	Switching	LAN, USB, Analog Control, (Opt)GPIB, RS-232	
CH2	80	13.5	360							
CH1	80	13.5	360	720	PSW-720L55	2	LED	Switching	LAN, USB, Analog Control, (Opt)GPIB, RS-232	
CH2	160	7.2	360							
CH1	160	7.2	360	720	PSW-720H66	2	LED	Switching	LAN, USB, Analog Control, (Opt)GPIB, RS-232	
CH2	160	7.2	360							
CH1	250	4.5	360	720	PSW-720H68	2	LED	Switching	LAN, USB, Analog Control, (Opt)GPIB, RS-232	
CH2	250	4.5	360							
CH1	250	4.5	360	720	PSW-720H88	2	LED	Switching	LAN, USB, Analog Control, (Opt)GPIB, RS-232	
CH2	800	1.44	360							
CH1	800	1.44	360	1080	PSW-1080L111	3	LED	Switching	LAN, USB, Analog Control, (Opt)GPIB, RS-232	
CH2	800	1.44	360							
CH3	160	7.2	360	1080	PSW-1080L112	3	LED	Switching	LAN, USB, Analog Control, (Opt)GPIB, RS-232	
CH1	30	36	360							
CH2	30	36	360	1080	PSW-1080L114	3	LED	Switching	LAN, USB, Analog Control, (Opt)GPIB, RS-232	
CH3	40	27	360							
CH1	30	36	360	1080	PSW-1080L115	3	LED	Switching	LAN, USB, Analog Control, (Opt)GPIB, RS-232	
CH2	30	36	360							
CH3	80	13.5	360	1080	PSW-1080L122	3	LED	Switching	LAN, USB, Analog Control, (Opt)GPIB, RS-232	
CH1	30	36	360							
CH2	30	36	360	1080	PSW-1080L115	3	LED	Switching	LAN, USB, Analog Control, (Opt)GPIB, RS-232	
CH3	160	7.2	360							
CH1	30	36	360	1080	PSW-1080L122	3	LED	Switching	LAN, USB, Analog Control, (Opt)GPIB, RS-232	
CH2	30	36	360							
CH3	40	27	360	1080	PSW-1080L122	3	LED	Switching	LAN, USB, Analog Control, (Opt)GPIB, RS-232	
CH1	30	36	360							

DC POWER SUPPLIES

	Voltage(V)	Current(A)	Power per. CH	Total Power(W)	Model Name	Channel	Display	Technic	Interface	Page									
CH1	30	36	360	1080	PSW-1080L124	3	LED	Switching	LAN, USB, Analog Control, (Opt)GPIB, RS-232	D9									
CH2	40	27	360																
CH3	80	13.5	360																
CH1	30	36	360	1080	PSW-1080L125	3	LED	Switching	LAN, USB, Analog Control, (Opt)GPIB, RS-232		D9								
CH2	40	27	360																
CH3	160	7.2	360																
CH1	30	36	360	1080	PSW-1080L144	3	LED	Switching	LAN, USB, Analog Control, (Opt)GPIB, RS-232			D9							
CH2	80	13.5	360																
CH3	80	13.5	360																
CH1	30	36	360	1080	PSW-1080L145	3	LED	Switching	LAN, USB, Analog Control, (Opt)GPIB, RS-232				D9						
CH2	80	13.5	360																
CH3	160	7.2	360																
CH1	30	36	360	1080	PSW-1080L155	3	LED	Switching	LAN, USB, Analog Control, (Opt)GPIB, RS-232					D9					
CH2	160	7.2	360																
CH3	160	7.2	360																
CH1	40	27	360	1080	PSW-1080L222	3	LED	Switching	LAN, USB, Analog Control, (Opt)GPIB, RS-232						D9				
CH2	40	27	360																
CH3	40	27	360																
CH1	40	27	360	1080	PSW-1080L224	3	LED	Switching	LAN, USB, Analog Control, (Opt)GPIB, RS-232							D9			
CH2	40	27	360																
CH3	80	13.5	360																
CH1	40	27	360	1080	PSW-1080L225	3	LED	Switching	LAN, USB, Analog Control, (Opt)GPIB, RS-232								D9		
CH2	40	27	360																
CH3	160	7.2	360																
CH1	40	27	360	1080	PSW-1080L244	3	LED	Switching	LAN, USB, Analog Control, (Opt)GPIB, RS-232									D9	
CH2	80	13.5	360																
CH3	80	13.5	360																
CH1	40	27	360	1080	PSW-1080L245	3	LED	Switching	LAN, USB, Analog Control, (Opt)GPIB, RS-232										D9
CH2	80	13.5	360																
CH3	160	7.2	360																
CH1	40	27	360	1080	PSW-1080L255	3	LED	Switching	LAN, USB, Analog Control, (Opt)GPIB, RS-232	D9									
CH2	160	7.2	360																
CH3	160	7.2	360																
CH1	80	13.5	360	1080	PSW-1080L444	3	LED	Switching	LAN, USB, Analog Control, (Opt)GPIB, RS-232		D9								
CH2	80	13.5	360																
CH3	80	13.5	360																
CH1	80	13.5	360	1080	PSW-1080L445	3	LED	Switching	LAN, USB, Analog Control, (Opt)GPIB, RS-232			D9							
CH2	80	13.5	360																
CH3	160	7.2	360																
CH1	80	13.5	360	1080	PSW-1080L455	3	LED	Switching	LAN, USB, Analog Control, (Opt)GPIB, RS-232				D9						
CH2	160	7.2	360																
CH3	160	7.2	360																
CH1	160	7.2	360	1080	PSW-1080L555	3	LED	Switching	LAN, USB, Analog Control, (Opt)GPIB, RS-232					D9					
CH2	160	7.2	360																
CH3	160	7.2	360																
CH1	250	4.5	360	1080	PSW-1080H666	3	LED	Switching	LAN, USB, Analog Control, (Opt)GPIB, RS-232						D9				
CH2	250	4.5	360																
CH3	250	4.5	360																
CH1	250	4.5	360	1080	PSW-1080H668	3	LED	Switching	LAN, USB, Analog Control, (Opt)GPIB, RS-232							D9			
CH2	250	4.5	360																
CH3	800	1.44	360																
CH1	250	4.5	360	1080	PSW-1080H688	3	LED	Switching	LAN, USB, Analog Control, (Opt)GPIB, RS-232								D9		
CH2	800	1.44	360																
CH3	800	1.44	360																
CH1	800	1.44	360	1080	PSW-1080H888	3	LED	Switching	LAN, USB, Analog Control, (Opt)GPIB, RS-232									D9	
CH2	800	1.44	360																
CH3	800	1.44	360																

NON-PROGRAMMABLE & MULTIPLE CHANNEL DC POWER SUPPLY

	Voltage(V)	Current(A)	Power per. CH	Total Power(W)	Model Name	Channel	Display	Technic	Page			
CH1	30	6	180	375	SPD-3606	3	LED	Switching	D38			
CH2	30	6	180									
CH3	5	3	15									
CH1	32	3	96	192	GPE-2323	2	LED	Linear	D64			
CH2	32	3	96									
CH1	32	3	96									
CH2	32	3	96	217	GPE-3323	3	LED	Linear		D64		
CH3	1.8/2.5/3.3/5.0	5	25									
CH1	32	3	96									
CH2	32	3	96	212	GPE-4323	4	LED	Linear			D64	
CH3	5	1	5									
CH4	15	1	15									
CH1	30	3	90	180	GPS-2303	2	LED	Linear				D65
CH2	30	3	90									
CH1	30	3	90	195	GPS-3303	3	LED	Linear				
CH2	30	3	90									
CH3	5	3	15									
CH1	30	3	90	200	GPS-4303	4	LED	Linear	D65			
CH2	30	3	90									
CH3	2.2 ~ 5.2	1	5.2									
CH4	8 ~ 15	1	15									
CH1	30	6	180	375	GPC-3060D	3	LED	Linear		D66		
CH2	30	6	180									
CH3	5	3	15									
CH1	60	3	180	375	GPC-6030D	3	LED	Linear			D66	
CH2	60	3	180									
CH3	5	3	15									

Dual-channel/Triple-channel Programmable Switching D.C. Power Supply



PSW-Multi Series

NEW

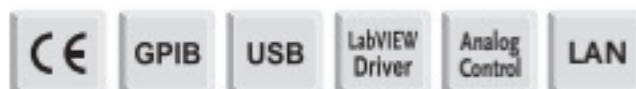

FEATURES

- * Multi-channel: Maximum 720W for Dual-channel Module and Maximum 1080W for Triple-channel Models; The PSW-Multi Series Also Features a New Built-in Function That Allows Individual Synchronizd Output Control of Each Voltage Module Output Latency Between Channels with the Same Voltage Module is Less Than 0.1ms
- * Multiple Voltage Combinations: Low Voltage Combinations Can be Selected From 30V/40V/80V/160V; High Voltage Combinations Can be Selected From 250V/800V
- * Advanced Web Server: Executes SCPI Commands; Web Controls Through Server; Data Log; Edit Sequence
- * CC/CV Priority Mode Selection is Ideal for Battery and LED Industries
- * Adjustable Rising and Falling Slew Rate
- * 720W/1080W Adopt 1/3, 1/2 Rack Mount Frame Designs (Standard EIA/JIS)
- * Standard Communications Interfaces: LAN, USB, External Analog Remote Control Terminal
- * Optional Communications Interfaces: GPIB-USB Adapter, RS232-USB Cable
- * Support LabVIEW Driver

GRA-410-J/E Rack Mount Kit (JIS/EIA)

For : PSW-Series



PSW-Multi Series is a dual-channel or triple-channel wide range output programmable switching DC power supply. The maximum output power can reach 1080W. There are 13 dual-channel models with a rated power of 720W, and 24 triple-channel models with a rated power of 1080W. The rated voltages of low voltage modules are 30V, 40V, 80V, 160V. The rated voltages of high voltage modules are 250V and 800V.

The CV/CC priority selection of the PSW-Multi Series is a very useful feature for DUT protection. The conventional power supply normally operates under CV mode when the power output is turned on. This could bring a high inrush current to the capacitive load or current-intensive load at the power output-on stage. Taking the I-V curve verification of LED as an example, it becomes a very challenging task to perform this measurement using a conventional power supply.

With LED connected to a power supply under CV mode as the initial setting, when the power output is turned on and the voltage rises to the LED forward voltage, the current will suddenly peak up and exceed the preset value of current limit. Upon detecting this high current, the power supply starts the transition from CV mode to CC mode. Though the current becomes stable after the CC mode being activated, the current spike occurred at the CV and CC crossover point may possibly damage the DUT. At the power output-on stage, the PSW-Multi Series is able to operate under CC priority to limit the current spike occurred at the threshold voltage and therefore protects DUT from the inrush current damage.

The adjustable slew rate of the PSW-Multi Series allows users to set for either output voltage or output current, a specific rise time from low to high level transition, and a specific fall time from high to low level transition. This facilitates the characteristic verification of a DUT during voltage or current level changes with controllable slew rates. Most manufacturing tests of lighting device or large capacitor during power output-on are associated with the occurrence of high surge current, which can greatly reduce the life time of the DUT. To prevent inrush current from damaging current-intensive devices, a smooth and slow voltage transition during power On-Off can significantly reduce the pike current and protect the device from high current damage.

The OVP and OCP are provided with the PSW-Multi Series. Both OVP and OCP levels can be selected, with default level set at 110%, of the rated voltage/current of the power supply. When any of the protection levels is tripped, the power output will be switched off to protect the DUT. The PSW-Multi Series provides USB Host/Device and LAN interfaces as standard, GPIB-USB adapter and RS232-USB cable as optional. The LabVIEW driver and the Data Logging PC software are supported on all the available interfaces. An analog control/monitoring connector is also available on the rear panel for external control of power On/Off and external monitoring of power output Voltage and Current.

DUAL-CHANNEL MODELS ARE AS FOLLOWS

MODEL	CH1	CH2	SIZE
PSW-720L11	30.00V	30.00V	1/3 Rack 3U
PSW-720L12	30.00V	40.00V	1/3 Rack 3U
PSW-720L14	30.00V	80.00V	1/3 Rack 3U
PSW-720L15	30.00V	160.0V	1/3 Rack 3U
PSW-720L22	40.00V	40.00V	1/3 Rack 3U
PSW-720L24	40.00V	80.00V	1/3 Rack 3U
PSW-720L25	40.00V	160.0V	1/3 Rack 3U
PSW-720L44	80.00V	80.00V	1/3 Rack 3U
PSW-720L45	80.00V	160.0V	1/3 Rack 3U
PSW-720L55	160.0V	160.0V	1/3 Rack 3U
PSW-720H66	250.0V	250.0V	1/3 Rack 3U
PSW-720H68	250.0V	800.0V	1/3 Rack 3U
PSW-720H88	800.0V	800.0V	1/3 Rack 3U

TRIPLE-CHANNEL MODELS ARE AS FOLLOWS

MODEL	CH1	CH2	CH3	SIZE
PSW-1080L111	30.00V	30.00V	30.00V	1/2 Rack 3U
PSW-1080L112	30.00V	30.00V	40.00V	1/2 Rack 3U
PSW-1080L114	30.00V	30.00V	80.00V	1/2 Rack 3U
PSW-1080L115	30.00V	30.00V	160.0V	1/2 Rack 3U
PSW-1080L122	30.00V	40.00V	40.00V	1/2 Rack 3U
PSW-1080L124	30.00V	40.00V	80.00V	1/2 Rack 3U
PSW-1080L125	30.00V	40.00V	160.0V	1/2 Rack 3U
PSW-1080L144	30.00V	80.00V	80.00V	1/2 Rack 3U
PSW-1080L145	30.00V	80.00V	160.0V	1/2 Rack 3U
PSW-1080L155	30.00V	160.0V	160.0V	1/2 Rack 3U
PSW-1080L222	40.00V	40.00V	40.00V	1/2 Rack 3U
PSW-1080L224	40.00V	40.00V	80.00V	1/2 Rack 3U
PSW-1080L225	40.00V	40.00V	160.0V	1/2 Rack 3U
PSW-1080L244	40.00V	80.00V	80.00V	1/2 Rack 3U
PSW-1080L245	40.00V	80.00V	160.0V	1/2 Rack 3U
PSW-1080L255	40.00V	160.0V	160.0V	1/2 Rack 3U
PSW-1080L444	80.00V	80.00V	80.0V	1/2 Rack 3U
PSW-1080L445	80.00V	80.00V	160.0V	1/2 Rack 3U
PSW-1080L455	80.00V	160.0V	160.0V	1/2 Rack 3U
PSW-1080L555	160.0V	160.0V	160.0V	1/2 Rack 3U
PSW-1080H666	250.0V	250.0V	250.0V	1/2 Rack 3U
PSW-1080H668	250.0V	250.0V	800.0V	1/2 Rack 3U
PSW-1080H688	250.0V	800.0V	800.0V	1/2 Rack 3U
PSW-1080H888	800.0V	800.0V	800.0V	1/2 Rack 3U

Notes :

- *1: At 85 ~ 132Vac or 170 ~ 265Vac, constant load.
- *2: From No-load to Full-load, constant input voltage. Measured at the sensing point in Remote Sense.
- *3: Measure with JEITA RC-9131B (1:1) probe
- *4: Measurement frequency bandwidth is 10Hz to 20MHz.
- *5: Measurement frequency bandwidth is 5Hz to 1MHz.

- *6: From 10% to 90% of rated output voltage, with rated resistive load.
- *7: From 90% to 10% of rated output voltage, with rated resistive load.
- *8: Time for output voltage to recover within 0.1% + 10mV of its rated output for a load change from 50 to 100% of its rated output current.
- *9: For load voltage change, equal to the unit voltage rating, constant input voltage.

SPECIFICATIONS

Module Type			1	2	4	5	6	8	
H/L Voltage Classification		—	L	L	L	L	H	H	
Rated output voltage		V	30	40	80	160	250	800	
Rated output current		A	36	27	13.5	7.2	4.5	1.44	
Rated output power		W	360	360	360	360	360	360	
Power ratio		—	3	3	3	3.2	3.125	3.2	
Constant Voltage Mode			30-36	40-27	80-13.5	160-7.2	250-4.5	800-1.44	
Line regulation (*1)		mV	18	23	43	83	128	403	
Load regulation (*2)		mV	20	25	45	85	130	405	
Ripple and noise (*3)	p-p (*4)	mV	60	60	60	60	80	150	
	r.m.s. (*5)	mV	7	7	7	12	15	30	
Temperature coefficient		ppm/°C	100ppm/°C of rated output voltage, after a 30 minute warm-up						
Remote sense compensation voltage (single wire)		V	0.6	0.6	0.6	0.6	1	1	
Rise time (*6)	Rated load	ms	50	50	50	100	100	150	
	No load	ms	50	50	50	100	100	150	
Fall time (*7)	Rated load	ms	50	50	50	100	150	300	
	No load	ms	500	500	500	1000	1200	2000	
Transient response time (*8)		ms	1	1	1	2	2	2	
Constant Current Mode			30-36	40-27	80-13.5	160-7.2	250-4.5	800-1.44	
Line regulation (*1)		mA	41	32	18.5	12.2	9.5	6.44	
Load regulation (*9)		mA	41	32	18.5	12.2	9.5	6.44	
Ripple and noise	r.m.s.	mA	72	54	27	15	10	5	
Temperature coefficient		ppm/°C	200ppm/°C of rated output current, after a 30 minute warm-up						
Protection Function			30-36	40-27	80-13.5	160-7.2	250-4.5	800-1.44	
Over voltage protection (OVP)	Setting range	V	3-33	4-44	8-88	16-176	20-275	20-880	
	Setting accuracy		± (2% of rated output voltage)						
Over current protection (OCP)	Setting range	A	3.6-39.6	2.7-29.7	1.35-14.85	0.72-7.92	0.45-4.95	0.144-1.584	
	Setting accuracy		± (2% of rated output current)						
Over temperature protection (OTP)	Operation		Turn the output off						
Low AC input protection (AC-FAIL)	Operation		Turn the output off						
Power limit (POWER LIMIT)	Operation		Over power limit.						
	Value (fixed)		Approx. 105% of rated output power						
Analog Programming and Monitoring			30-36	40-27	80-13.5	160-7.2	250-4.5	800-1.44	
External voltage control output voltage	at 23 °C ± 5 °C		Accuracy and linearity: ±0.5% of rated output voltage.						
External voltage control output current	at 23 °C ± 5 °C		Accuracy and linearity: ±1% of rated output current.						
External resistor control output voltage	at 23 °C ± 5 °C		Accuracy and linearity: ±1.5% of rated output voltage.						
External resistor control output current	at 23 °C ± 5 °C		Accuracy and linearity: ±1.5% of rated output current.						
Output voltage monitor	at 23 °C ± 5 °C		Accuracy: ±1%						
Output current monitor	at 23 °C ± 5 °C		Accuracy: ±1%						
Shutdown control			Turns the output off with a LOW (0V to 0.5V) or short-circuit						
Output on/off control			Possible logic selections: Turn the output on using a LOW (0V to 0.5V) or short-circuit, turn the output off using a HIGH (4.5V to 5V) or open-circuit. Turn the output on using a HIGH (4.5V to 5V) or open-circuit, turn the output off using a LOW (0V to 0.5V) or short-circuit.						
CV/CC/ALM/PWR ON/OUT ON indicator			Photocoupler open collector output; Maximum voltage 30V, maximum sink current 8mA.						
Front Panel			30-36	40-27	80-13.5	160-7.2	250-4.5	800-1.44	
Display, 4 digits	Voltage accuracy	at 23 °C ± 5 °C; ± (0.1% +	mV	20	20	20	100	200	400
	Current accuracy	at 23 °C ± 5 °C; ± (0.1% +	mA	40	30	20	5	5	2
Indications			GREEN LED's: CV, CC, VSR, ISR, DLY, RMT, 20, 40, 60, 80, 100, %W, W, V, A						
			RED LED's: ALM						
Buttons			Function, OVP/OCP, Set, Test, Lock/Local, PWR DSPL, Output						
Knobs			Voltage, Current						
USB port			Type A USB connector						
Programming and Measurement (USB, LAN, GPIB)			30-36	40-27	80-13.5	160-7.2	250-4.5	800-1.44	
Output voltage programming accuracy	at 23 °C ± 5 °C; ± (0.1% +	mV	10	10	10	100	200	400	
Output current programming accuracy	at 23 °C ± 5 °C; ± (0.1% +	mA	30	20	10	5	5	2	
Output voltage programming resolution		mV	1	1	2	3	5	14	
Output current programming resolution		mA	1	1	1	1	1	1	
Output voltage measurement accuracy	at 23 °C ± 5 °C; ± (0.1% +	mV	10	10	10	100	200	400	
Output current measurement accuracy	at 23 °C ± 5 °C; ± (0.1% +	mA	30	20	10	5	5	2	
Output voltage measurement resolution		mV	1	1	2	3	5	14	
Output current measurement resolution		mA	1	1	1	1	1	1	
Input Characteristics			30-36	40-27	80-13.5	160-7.2	250-4.5	800-1.44	
Efficiency	100Vac	%	77	78	78	79	79	80	
	200Vac	%	79	80	80	81	81	82	
Input Characteristics			Dual Channel			Triple Channel			
Nominal input rating			100Vac to 240Vac, 50Hz to 60Hz, single phase						
Input voltage range			85Vac ~ 265Vac						
Input frequency range			47Hz ~ 63Hz						
Maximum input current	100Vac	A	10			15			
	200Vac	A	5			7.5			
Inrush current			Less than 50A			Less than 75A			
Maximum input power		VA	1000			1500			
Power factor	100Vac		0.99						
	200Vac		0.97						
Hold-up time			20ms or greater						
Interface Capabilities			Dual Channel			Triple Channel			
USB			TypeA: Host, TypeB: Slave, Speed: 1.1/2.0, USB Class: CDC(Communications Device Class)						
LAN			MAC Address, DNS IP Address, User Password, Gateway IP Address, Instrument IP Address, Subnet Mask						
GPIB			Optional: GUC-001 (GPIB to USB Adapter)						
Environmental Conditions			Dual Channel			Triple Channel			
Operating temperature			0 °C to 50 °C						
Storage temperature			-25 °C to 70 °C						
Operating humidity			20% to 85% RH; No condensation						
Storage humidity			90% RH or less; No condensation						
Altitude			Maximum 2000m						
General Specifications			Dual Channel			Triple Channel			
Weight	main unit only	kg	Approx. 5.4kg			Approx. 7.7kg			
Dimensions	(W×H×D)	mm	142 x 124 x 350			214 x 124 x 350			
Cooling			Forced air cooling by internal fan						
EMC			Complies with the European EMC directive for Class A test and measurement products						
Safety			Complies with the European Low Voltage Directive and carries the CE-marking						
Withstand voltage	Between input and chassis		No abnormalities at 1500 Vac for 1 minute						
	Between input and output		No abnormalities at 3000 Vac for 1 minute						
	Between output and chassis		No abnormalities at 500 Vdc for 1 minute for 30V, 40V, 80V, 160V models No abnormalities at 1500 Vdc for 1 minute for 250V, 800V models						
Insulation resistance	Between input and chassis		500 Vdc, 100 MΩ or more						
	Between input and output		500 Vdc, 100 MΩ or more						
	Between output and chassis		500 Vdc, 100 MΩ or more for 30V, 40V, 80V, 160V and 250V models 1000 Vdc, 100 MΩ or more for 800V models						

Dual-channel/Triple-channel Programmable Switching D.C. Power Supply



PSW-Multi Series(Three-channel)



PSW-Multi Series(Two-channel)



PSW-Multi Series (LV)
Three-channel Models Rear Panel



PSW-Multi Series (HV)
Three-channel Models Rear Panel



PSW-Multi Series (LV)
Two-channel Models Rear Panel



PSW-Multi Series (HV)
Two-channel Models Rear Panel

ORDERING INFORMATION

Dual Channel Model

PSW-720L11	30V/36A*2	720W Multi-Range D.C. Power Supply
PSW-720L12	30V/36A*1 40V/27A*1	720W Multi-Range D.C. Power Supply
PSW-720L14	30V/36A*1 80V/13.5A*1	720W Multi-Range D.C. Power Supply
PSW-720L15	30V/36A*1 160V/7.2A*1	720W Multi-Range D.C. Power Supply
PSW-720L22	40V/27A*2	720W Multi-Range D.C. Power Supply
PSW-720L24	40V/27A*1 80V/13.5A*1	720W Multi-Range D.C. Power Supply
PSW-720L25	40V/27A*1 160V/7.2A*1	720W Multi-Range D.C. Power Supply
PSW-720L44	80V/13.5A*2	720W Multi-Range D.C. Power Supply
PSW-720L45	80V/13.5A*1 160V/7.2A*1	720W Multi-Range D.C. Power Supply
PSW-720L55	160V/7.2A*2	720W Multi-Range D.C. Power Supply
PSW-720H66	250V/4.5A*2	720W Multi-Range D.C. Power Supply
PSW-720H68	250V/4.5A*1 800V/1.44A*1	720W Multi-Range D.C. Power Supply
PSW-720H88	800V/1.44A*2	720W Multi-Range D.C. Power Supply

Triple Channel Model

PSW-1080L111	30V/36A*3	1080W Multi-Range D.C. Power Supply
PSW-1080L112	30V/36A*2 40V/27A*1	1080W Multi-Range D.C. Power Supply
PSW-1080L114	30V/36A*2 80V/13.5A*1	1080W Multi-Range D.C. Power Supply
PSW-1080L115	30V/36A*2 160V/7.2A*1	1080W Multi-Range D.C. Power Supply
PSW-1080L122	30V/36A*1 40V/27A*2	1080W Multi-Range D.C. Power Supply
PSW-1080L124	30V/36A*1 40V/27A*1 80V/13.5A*1	1080W Multi-Range D.C. Power Supply
PSW-1080L125	30V/36A*1 40V/27A*1 160V/7.2A	1080W Multi-Range D.C. Power Supply
PSW-1080L144	30V/36A*1 80V/13.5A*2	1080W Multi-Range D.C. Power Supply
PSW-1080L145	30V/36A*1 80V/13.5A*1 160V/7.2A*1	1080W Multi-Range D.C. Power Supply
PSW-1080L155	30V/36A*1 160V/7.2A*2	1080W Multi-Range D.C. Power Supply
PSW-1080L222	40V/27A*3	1080W Multi-Range D.C. Power Supply
PSW-1080L224	40V/27A*2 80V/13.5A*1	1080W Multi-Range D.C. Power Supply
PSW-1080L225	40V/27A*2 160V/7.2A*1	1080W Multi-Range D.C. Power Supply
PSW-1080L244	40V/27A*1 80V/13.5A*2	1080W Multi-Range D.C. Power Supply
PSW-1080L245	40V/27A*1 80V/13.5A*1 160V/7.2A*1	1080W Multi-Range D.C. Power Supply
PSW-1080L255	40V/27A*1 160V/7.2A*2	1080W Multi-Range D.C. Power Supply
PSW-1080L444	80V/13.5A*3	1080W Multi-Range D.C. Power Supply
PSW-1080L445	80V/13.5A*2 160V/7.2A*1	1080W Multi-Range D.C. Power Supply
PSW-1080L455	80V/13.5A*1 160V/7.2A*2	1080W Multi-Range D.C. Power Supply
PSW-1080L555	160V/7.2A*3	1080W Multi-Range D.C. Power Supply
PSW-1080H666	250V/4.5A*3	1080W Multi-Range D.C. Power Supply
PSW-1080H668	250V/4.5A*2 800V/1.44A*1	1080W Multi-Range D.C. Power Supply
PSW-1080H688	250V/4.5A*1 800V/1.44A*2	1080W Multi-Range D.C. Power Supply
PSW-1080H888	800V/1.44A*3	1080W Multi-Range D.C. Power Supply

Apart from the differences in output type, each unit differs at output channels and voltage.
The PSW-720 is dual channel output and PSW-1080 is triple channel output.

ACCESSORIES :

	Power Cord x1 (Region dependent)
GTL-123	Test Lead x 1 (30V/40V/80V/160V One low voltage module for each channel)
GTL-240	USB Cable "L" Type x1
PSW-004	Basic Accessories Kit x1 (30V/40V/80V/160V low voltage module)
PSW-008	Basic Accessories Kit x1 (250V/800V high voltage module)
PSW-009	Output terminal cover (30V/40V/80V/160V low voltage module)
PSW-011	Output terminal cover (250V/800V high voltage module)
PSW-012	High voltage output terminal (250V/800V high voltage module)

OPTIONAL ACCESSORIES

PSW-001	Accessory Kit
PSW-002	Simple IDC Tool
PSW-003	Contact Removal Tool
GUG-001	GPIB to USB Adaptor
GRA-410-J	Rack Mount Kit(JIS)
GRA-410-E	Rack Mount Kit(KIA)
GET-001	Extended Terminal with max. 30A (30V/40V/80V/160V low voltage module)
GET-002	Extended Terminal with max. 10A (250V/800V high voltage module)
GET-005	Extended European Terminal with max. 20A (30V/40V/80V/160V low voltage module)
GTL-130	Test Lead: 2x red, 2x black (250V/800V high voltage module)
GTL-248	GPIB Cable, 2000mm
GTL-250	GPIB Cable, 600mm
GUR-001A	USB to RS-232 Cable (M3), 3000mm
GUR-001B	USB to RS-232 Cable (#4-40 UNC), 3000mm



A. MULTI-RANGE OPERATION

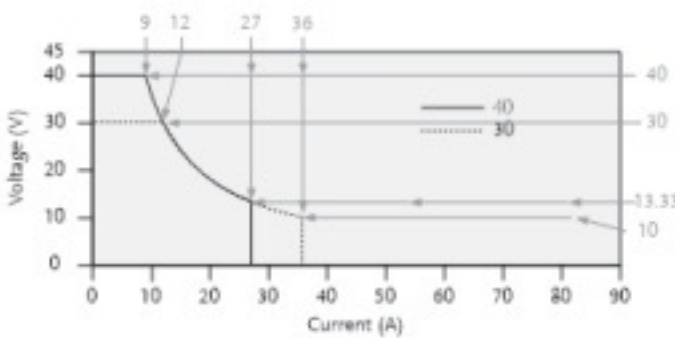

PSW 30V/40V Series Operating Area

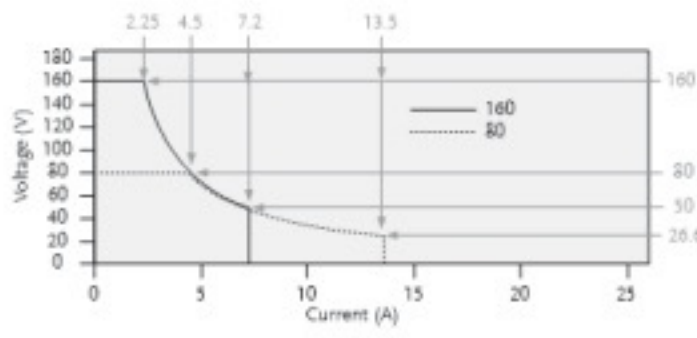

PSW 80V/160V Series Operating Area

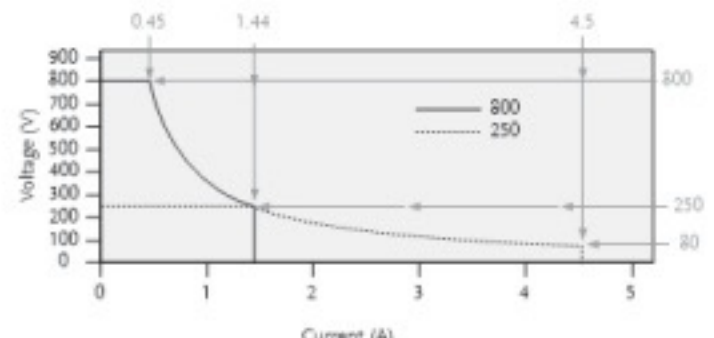

PSW 250V/800V Series Operating Area

When the power supply is configured that the total output (Current x Voltage output) is less than the rated power output, it functions as a typical Constant Current (CC) and Constant Voltage (CV) power supply.

However, when the power supply is configured such that the total output power (Current x Voltage Output) exceeds the rated power output, the effective output is actually limited to the operation area of the unit.

B. MULTI-CHANNEL

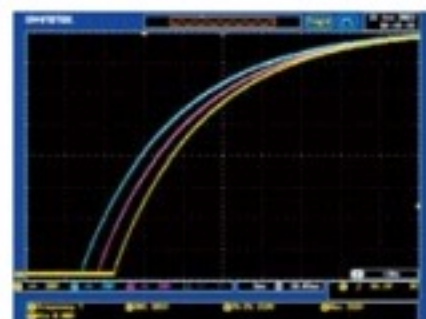

Figure 1

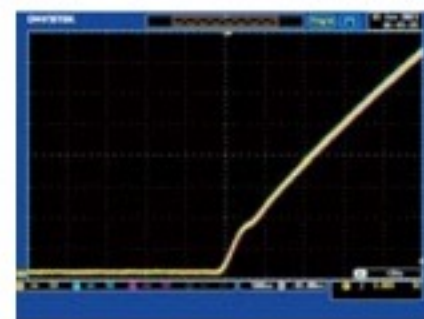

Figure 2

Multi-Channel, Dual-channel or triple-channel; the output latency between channels for same voltage module is less than 0.1ms.

When using a single-channel power supply with three units connected in parallel through the backplane for synchronized output, each unit will experience a voltage output latency of approximately 5 to 10 ms. (Figure 1)

When using a single-channel power supply for parallel multiple voltage output testing, there are different delays and slew rate settings, resulting in longer voltage output delay times and lack of control. The PSW-Multi Series features a built-in synchronous output control function (F130) that allow Dual-channel or triple-channel; the output latency between channels for same voltage module is less than 0.1ms.

The waveform of PSW-Multi Series in triple-channel synchronized output mode exhibits voltage output latency times less than 0.1 ms for each channel (with the same voltage model) (Figure 2)

It can fulfill diverse testing applications, for example: multi-channel digital device testing, electronic circuit verification, battery charging and discharging testing, and more.

Dual-channel/Triple-channel Programmable Switching D.C. Power Supply

C. ADVANCED WEB SERVER



Figure 1



Figure 2



Figure 3



Figure 4



SCPI commands can be issued directly on the browser, examples are as follows: Direct control of PSW-Multi series power supplies on the browser. (Figure 1)

Data Log can be performed on the browser. For standard web server, the fastest data log time interval is 1 second. PSW-Multi series also provide paid version (active by option license key), the fastest data log time interval is 0.1 seconds and the data save to USB drive directly. (Figure 2)

Sequences can be edited on the browser. (Figure 3)

The above advanced web server functions are new functions of PSW-Multi. Currently, there is no plan to update the advanced web server in the existing PSW-Series (Single Channel). (Figure 4)

D. CV / CC PRIORITY SELECTION



The Inrush Current and Surge Voltage occur at LED Forward Voltage (V_f) Under C.V Priority



The CC Priority Feature Effectively Limits the Occurrence of Inrush Current and Surge Voltage when the Supplied Voltage Rises to the LED Forward Voltage

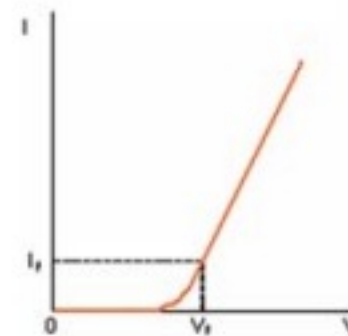

V-I Characteristic of Diode

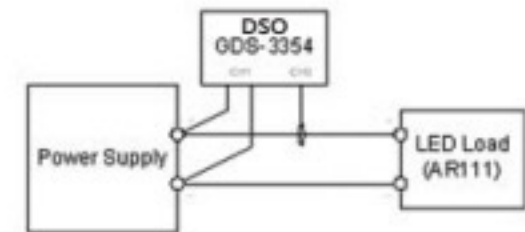

Using GDS-3354 DSO to Test LED Operation Under CV Priority and CC Priority Respectively

The PSW-Multi Series provides CC Mode and CV Mode to fit various applications in the general purpose market. To get into critical application niches, however, the power supply needs to provide advanced features

to meet the specific requirements. The CC and CV Priority Selection enable the power supply to run under CC priority, rather than normal CV priority, at the output-on stage.

E. ADJUSTABLE SLEW RATE

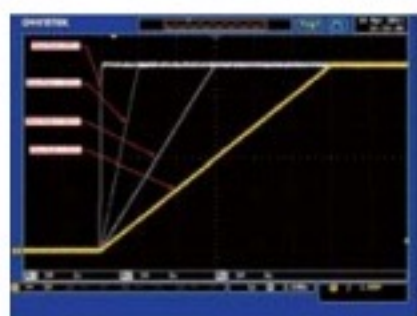

The Adjustable Rise Time of the PSW 30V Module



The Adjustable Rise Time of the PSW 800V Module

The PSW-Multi Series has adjustable slew rates for the level transition of both Current and Voltage. This gives the PSW-Multi Series power supply the ability to set specific rise time and fall time of the Voltage and Current drawn from the power supply to verify DUT performance during the Voltage/Current level transition. The feature also provides the benefit to slow down the voltage transition at the power output-on to protect DUT from inrush current damage. This is especially useful for the test of heavy-current-drawn devices like capacitors.

F. BLEEDER CONTROL

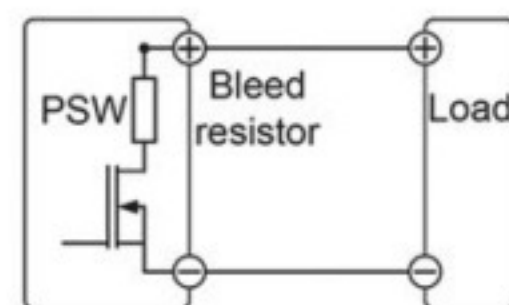

PSW-Multi Series Built-in Bleed Resistor

The PSW-Multi Series employs a bleed resistor in parallel with the output terminal. Bleed resistor is designed to dissipate the power from the power supply filter capacitors when power is turned off and the load is disconnected. Without a bleed resistor, power terminal may remain charged on the filter capacitors for some time and be potentially hazardous. In addition, bleed resistor also allows for smoother voltage regulation of the power supply as the bleed resistor acts as a minimum voltage load. The bleed resistance can be turned on or off using the configuration setting.

G. EXTERNAL ANALOG REMOTE CONTROL

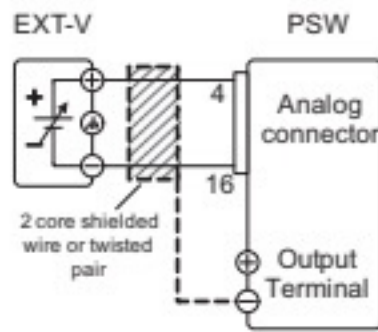

External Voltage Control of the Voltage Output

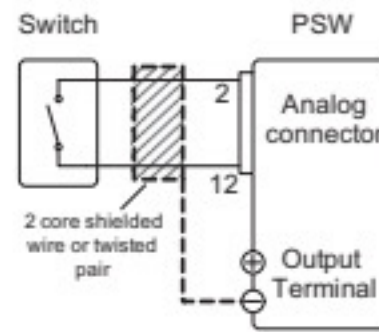

External Switch Control of the Main Power Shut-down

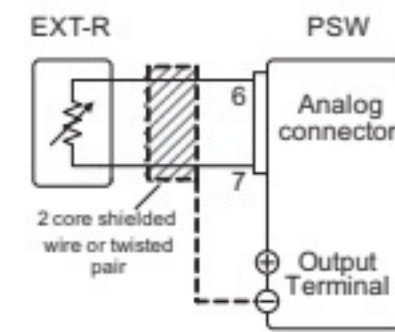

External Resistance control of the Voltage Output

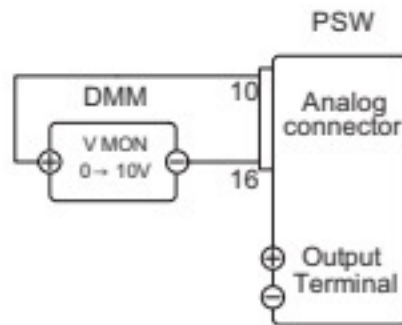

External DMM Monitoring of the Output Voltage

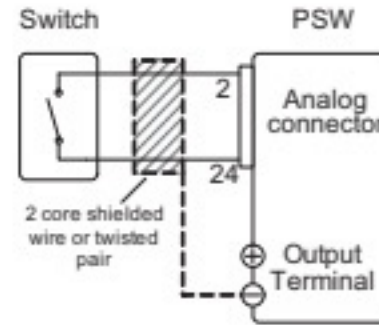

External Switch Control of the Output On/Off

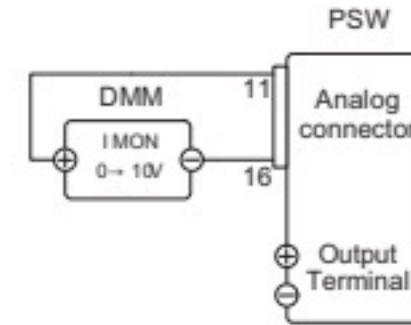

External DMM Monitoring of the Output Current

On the rear panel of the PSW-Multi Series power supply, a 26-pin Analog Control connector is available to perform lots of remote control and monitoring functions. The output voltage and current can be set using external voltage or resistance.

The power supply output on/off and main power shut-down can also be controlled using external switches. This Analog Control Connector is complied with the Mil 26 pin connector (OMRON XG4 IDC plug) standard.

H. VARIOUS INTERFACES SUPPORT & EXTENDED TERMINAL BOX



Rear Panel for PSW-Multi Series



The PSW-Multi Series provides USB Host port in the front panel for easy access of stored data, such as test script program. In the rear panel, a USB Device port is available for remote control or I & V data logging of power output through a PC controller. The LAN interface, which meets DHCP standard, is provided as a standard feature of the PSW-Multi Series for system communications and ATE applications.

An Extender Terminal box (P/N: GET-001/GET-002/GET-005) is provided as optional accessory to extend the power output form the rear panel to the front side. This extender terminal gives R&D or QC engineers convenience to do the jobs without frequently reaching the output terminal at the rear side of the PSW-Multi Series.

I. USING THE RACK MOUNT KIT



Rack Mount Kit GRA-410-J (JIS)



Rack Mount Kit GRA-410-E (EIA)

The PSW-Multi Series has an optional Rack Mount Kit (GW Instek part number: [JIS] GRA-410-J, [EIA] GRA-410-E[EIA]) that can be used to hold

6x PSW models, 3x PSW-720 models, 2x PSW-1080 models or a combination of all models (1x PSW, 1x PSW-720 and 1x PSW-1080).

Programmable Switching D.C. Power Supply (Multi-Range D.C. Power Supply)



PSW-Series



FEATURES

- * Voltage Rating : 30V/40V/80V/160V/250V/800V, Output Power Rating : 360W~1080W
- * Multi-range Voltage & Current Combinations in One Power Supply
- * C.V/C.C Priority ; Particularly Suitable for the Battery and LED Industry
- * Adjustable Slew Rate
- * Series Operation(2 units in Series)for(30V/40V/80V/160V), Parallel Operation(3 units in Parallel) for (30V/40V/80V/160V/250V/800V)
- * High Efficiency and High Power Density
- * 1/2, 1/3, 1/6 Rack Mount Size Design (EIA/JIS Standard) for 360W, 720W, 1080W
- * Standard Interface : LAN, USB, Analog Control Interface
- * Optional Interface : GPIB-USB Adaptor, RS232-USB Cable
- * LabVIEW Driver



PSW 80-40.5 (0-80V, 0-40.5A, 1080W)



PSW 80-27 (0-80V, 0-27A, 720W)



PSW 80-13.5 (0-80V, 0-13.5A, 360W)

The PSW-Series is a single-output multi-range programmable switching DC Power Supply covering a power range up to 1080W. This series of products include eighteen models with the combination of 30V, 40V, 80V, 160V, 250V and 800V rated voltages and 360W, 720W and 1080W maximum output powers. The multi-range feature allows the flexible and efficient configuration of voltage and current within the rated power range. As the PSW-Series can be connected in series for maximum 2 units or in parallel for maximum 3 units, the capability of connecting multiple PSW-Series units for higher voltage or higher current output provides a broad coverage of applications. With the flexibility of multi-range power utilization and series/parallel connection, the PSW-Series significantly reduces the users' cost for various power supply products to accommodate the projects with different power requirements.

The C.V/C.C priority selection of the PSW-Series is a very useful feature for DUT protection. The conventional power supply normally operates under C.V mode when the power output is turned on. This could bring a high inrush current to the capacitive load or current-intensive load at the power output-on stage. Taking the I-V curve verification of LED as an example, it becomes a very challenging task to perform this measurement using a conventional power supply. With LED connected to a power supply under C.V mode as the initial setting, when the power output is turned on and the voltage rises to the LED forward voltage, the current will suddenly peak up and exceed the preset value of current limit. Upon detecting this high current, the power supply starts the transition from C.V mode to C.C mode. Though the current becomes stable after the C.C mode being activated, the current spike occurred at the C.V and C.C crossover point may possibly damage the DUT. At the power output-on stage, the PSW-Series is able to operate under C.C priority to limit the current spike occurred at the threshold voltage and therefore protects DUT from the inrush current damage.

The adjustable slew rate of the PSW-Series allows users to set for either output voltage or output current, a specific rise time from low to high level transition, and a specific fall time from high to low level transition. This facilitates the characteristic verification of a DUT during voltage or current level changes with controllable slew rates. Most manufacturing tests of lighting device or large capacitor during power output-on are associated with the occurrence of high surge current, which can greatly reduce the life time of the DUT. To prevent inrush current from damaging current-intensive devices, a smooth and slow voltage transition during power On-Off can significantly reduce the spike current and protect the device from high current damage.

The OVP and OCP are provided with the PSW-Series. Both OVP and OCP levels can be selected, with default level set at 110%, of the rated voltage/current of the power supply. When any of the protection levels is tripped, the power output will be switched off to protect the DUT. The PSW-Series provides USB Host/Device and LAN interfaces as standard, GPIB-USB adapter and RS232-USB cable as optional. The LabView driver and the Data Logging PC software are supported on all the available interfaces. An analog control/monitoring connector is also available on the rear panel for external control of power On/Off and external monitoring of power output Voltage and Current.

PARALLEL OPERATION (3 UNITS)

MODEL	SINGLE UNIT	2 UNITS	3 UNITS
PSW 30-36	30V/36A	30V/72A	30V/108A
PSW 30-72	30V/72A	30V/144A	30V/216A
PSW 30-108	30V/108A	30V/216A	30V/324A
PSW 40-27	40V/27A	40V/54A	40V/81A
PSW 40-54	40V/54A	40V/108A	40V/162A
PSW 40-81	40V/81A	40V/162A	40V/243A
PSW 80-13.5	80V/13.5A	80V/27A	80V/40.5A
PSW 80-27	80V/27A	80V/54A	80V/81A
PSW 80-40.5	80V/40.5A	80V/81A	80V/121.5A
PSW 160-7.2	160V/7.2A	160V/14.4A	160V/21.6A
PSW 160-14.4	160V/14.4A	160V/28.8A	160V/43.2A
PSW 160-21.6	160V/21.6A	160V/43.2A	160V/64.8A
PSW 250-4.5	250V/4.5A	250V/9A	250V/13.5A
PSW 250-9	250V/9A	250V/18A	250V/27A
PSW 250-13.5	250V/13.5A	250V/27A	250V/40.5A
PSW 800-1.44	800V/1.44A	800V/2.88A	800V/4.32A
PSW 800-2.88	800V/2.88A	800V/5.76A	800V/8.64A
PSW 800-4.32	800V/4.32A	800V/8.64A	800V/12.96A

SERIES OPERATION (2 UNITS)

MODEL	SINGLE UNIT	2 UNITS
PSW 30-36	30V/36A	60V/36A
PSW 30-72	30V/72A	60V/72A
PSW 30-108	30V/108A	60V/108A
PSW 40-27	40V/27A	80V/27A
PSW 40-54	40V/54A	80V/54A
PSW 40-81	40V/81A	80V/81A
PSW 80-13.5	80V/13.5A	160V/13.5A
PSW 80-27	80V/27A	160V/27A
PSW 80-40.5	80V/40.5A	160V/40.5A
PSW 160-7.2	160V/7.2A	320V/7.2A
PSW 160-14.4	160V/14.4A	320V/14.4A
PSW 160-21.6	160V/21.6A	320V/21.6A
PSW 250-4.5	N/A	N/A
PSW 250-9	N/A	N/A
PSW 250-13.5	N/A	N/A
PSW 800-1.44	N/A	N/A
PSW 800-2.88	N/A	N/A
PSW 800-4.32	N/A	N/A

SPECIFICATIONS									
	PSW 30-36	PSW 30-72	PSW 30-108	PSW 40-27	PSW 40-54	PSW 40-81	PSW 80-13.5	PSW 80-27	PSW 80-40.5
OUTPUT RATING									
Voltage	0 – 30V	0 – 30V	0 – 30V	0 – 40V	0 – 40V	0 – 40V	0 – 80V	0 – 80V	0 – 80V
Current	0 – 36A	0 – 72A	0 – 108A	0 – 27A	0 – 54A	0 – 81A	0 – 13.5A	0 – 27A	0 – 40.5A
Power	360W	720W	1080W	360W	720W	1080W	360W	720W	1080W
REGULATION(CV)									
Load	20mV	20mV	20mV	25mV	25mV	25mV	45mV	45mV	45mV
Line	18mV	18mV	18mV	23mV	23mV	23mV	43mV	43mV	43mV
REGULATION(CC)									
Load	41mA	77mA	113mA	32mA	59mA	86mA	18.5mA	32mA	45.5mA
Line	41mA	77mA	113mA	32mA	59mA	86mA	18.5mA	32mA	45.5mA
RIPPLE & NOISE (Noise Bandwidth 20MHz; Ripple Bandwidth=1MHz)									
CV p-p	60mV	80mV	100mV	60mV	80mV	100mV	60mV	80mV	100mV
CV rms	7mV	11mV	14mV	7mV	11mV	14mV	7mV	11mV	14mV
CC rms	72mA	144mA	216mA	54mA	108mA	162mA	27mA	54mA	81mA
PROGRAMMING ACCURACY									
Voltage	0.1% +10mV	0.1% +10mV	0.1% +10mV	0.1%+10mV	0.1%+10mV	0.1%+10mV	0.1% +10mV	0.1% +10mV	0.1% +10mV
Current	0.1% + 30mA	0.1% + 60mA	0.1% + 100mA	0.1%+20mA	0.1%+50mA	0.1%+80mA	0.1% + 10mA	0.1% + 30mA	0.1% + 40mA
MEASUREMENT ACCURACY									
Voltage	0.1% +10mV	0.1% +10mV	0.1% +10mV	0.1%+10mV	0.1%+10mV	0.1%+10mV	0.1% +10mV	0.1% +10mV	0.1% +10mV
Current	0.1% +30mA	0.1% +60mA	0.1% +100mA	0.1%+20mA	0.1%+50mA	0.1%+80mA	0.1% +10mA	0.1% +30mA	0.1% +40mA
RESPONSE TIME									
Raise Time	50ms	50ms	50ms	50ms	50ms	50ms	50ms	50ms	50ms
Fall Time(Full Load)	50ms	50ms	50ms	50ms	50ms	50ms	50ms	50ms	50ms
Fall Time(No Load)	500ms	500ms	500ms	500ms	500ms	500ms	500ms	500ms	500ms
Load Transient Recover Time (Load change from 50-100%)	1ms	1ms	1ms	1ms	1ms	1ms	1ms	1ms	1ms
PROGRAMMING RESOLUTION (By PC Remote Control Mode)									
Voltage	1mV	1mV	1mV	1mV	1mV	1mV	2mV	2mV	2mV
Current	1mA	2mA	3mA	1mA	2mA	3mA	1mA	2mA	3mA
MEASUREMENT RESOLUTION (By PC Remote Control Mode)									
Voltage	1mV	1mV	1mV	1mV	1mV	1mV	2mV	2mV	2mV
Current	1mA	2mA	3mA	1mA	2mA	3mA	1mA	2mA	3mA
SERIES AND PARALLEL CAPABILITY									
Parallel Operation	Up to 3 units including the master unit								
Series Operation	Up to 2 units including the master unit								
PROTECTION FUNCTION									
OVP	3-33V	3-33V	3-33V	4 – 44V	4 – 44V	4 – 44V	8-88V	8-88V	8-88V
OCP	3.6 –39.6A	5-79.2A	5-118.8A	2.7 – 29.7A	5 – 59.4A	5 – 89.1A	1.35-14.85A	2.7-29.7A	4.05-44.55A
OHP	Activated by elevated internal temperatures								
FRONT PANEL DISPLAY ACCURACY, 4 digits									
Voltage	0.1%±20mV	0.1%±20mV	0.1%±20mV	0.1%+20mV	0.1%+20mV	0.1%+20mV	0.1%±20mV	0.1%±20mV	0.1%±20mV
Current	0.1%±40mA	0.1%±70mA	0.1%±100mA	0.1%+30mA	0.1%+60mA	0.1%+80mA	0.1%±20mA	0.1%±40mA	0.1%±50mA
ENVIRONMENT CONDITION									
Operation Temp	0°C – 50°C								
Storage Temp	-25°C – 70°C								
Operating Humidity	20% – 85% RH; No condensation								
Storage Humidity	90% RH or Less; No condensation								
READ BACK TEMP COEFFICIENT									
Voltage	100ppm/°C of rated output voltage : after a 30 minute warm-up								
Current	200ppm/°C of rated output current : after a 30 minute warm-up								
OTHER									
Analog Control	Yes								
Interface	USB/LAN/GPIB-USB(Optional)/RS232-USB(Optional)								
Fan	With thermal sensing control								
POWER SOURCE	85VAC-265VAC, 47-63Hz, single phase								
DIMENSIONS & WEIGHT	71(W)x124(H) x350(D) mm ; Approx. 3kg	142(W)x124(H) x350(D)mm ; Approx. 5.3kg	214(W)x124(H) x350(D) mm ; Approx. 7.5kg	71(W)x124(H) x350(D) mm ; Approx. 3kg	142(W)x124(H) x350(D) mm ; Approx. 5.3kg	214(W)x124(H) x350(D) mm ; Approx. 7.5kg	71(W)x124(H) x350(D) mm ; Approx. 3kg	142(W)x124(H) x350(D) mm ; Approx. 5.3kg	214(W)x124(H) x350(D) mm ; Approx. 7.5kg

PSW-001



PSW-002



PSW-003



PSW-004



PSW-005



PSW-006



PSW-007



Programmable Switching D.C. Power Supply (Multi-Range D.C. Power Supply)

SPECIFICATIONS									
	PSW 160-7.2	PSW 160-14.4	PSW 160-21.6	PSW 250-4.5	PSW 250-9	PSW 250-13.5	PSW 800-1.44	PSW 800-2.88	PSW 800-4.32
OUTPUT RATING									
Voltage	0 – 160V	0 – 160V	0 – 160V	0 – 250V	0 – 250V	0 – 250V	0 – 800V	0 – 800V	0 – 800V
Current	0 – 7.2A	0 – 14.4A	0 – 21.6A	0 – 4.5A	0 – 9A	0 – 13.5A	0 – 1.44A	0 – 2.88A	0 – 4.32A
Power	360W	720W	1080W	360W	720W	1080W	360W	720W	1080W
REGULATION(CV)									
Load	85mV	85mV	85mV	130mV	130mV	130mV	405mV	405mV	405mV
Line	83mV	83mV	83mV	128mV	128mV	128mV	403mV	403mV	403mV
REGULATION(CC)									
Load	12.2mA	19.4mA	26.6mA	9.5mA	14mA	18.5mA	6.44mA	7.88mA	9.32mA
Line	12.2mA	19.4mA	26.6mA	9.5mA	14mA	18.5mA	6.44mA	7.88mA	9.32mA
RIPPLE & NOISE (Noise Bandwidth 20MHz; Ripple Bandwidth=1MHz)									
CV p-p	60mV	80mV	100mV	80mV	100mV	120mV	150mV	200mV	200mV
CV rms	12mV	15mV	20mV	15mV	15mV	15mV	30mV	30mV	30mV
CC rms	15mA	30mA	45mA	10mA	20mA	30mA	5mA	10mA	15mA
PROGRAMMING ACCURACY									
Voltage	0.1% +100mV	0.1% +100mV	0.1% +100mV	0.1%+200mV	0.1%+200mV	0.1%+200mV	0.1%+400mV	0.1%+400mV	0.1%+400mV
Current	0.1% + 5mA	0.1% +15mA	0.1% +20mA	0.1%+5mA	0.1%+10mA	0.1%+15mA	0.1%+2mA	0.1%+4mA	0.1%+6mA
MEASUREMENT ACCURACY									
Voltage	0.1% +100mV	0.1% +100mV	0.1% +100mV	0.1%+200mV	0.1%+200mV	0.1%+200mV	0.1%+400mV	0.1%+400mV	0.1%+400mV
Current	0.1% +5mA	0.1% +15mA	0.1% +20mA	0.1%+5mA	0.1%+10mA	0.1%+15mA	0.1%+2mA	0.1%+4mA	0.1%+6mA
RESPONSE TIME									
Raise Time	100ms	100ms	100ms	100ms	100ms	100ms	150ms	150ms	150ms
Fall Time(Full Load)	100ms	100ms	100ms	150ms	150ms	150ms	300ms	300ms	300ms
Fall Time(No Load)	1000ms	1000ms	1000ms	1200ms	1200ms	1200ms	2000ms	2000ms	2000ms
Load Transient Recover Time (Load change from 50~100%)	2ms	2ms	2ms	2ms	2ms	2ms	2ms	2ms	2ms
PROGRAMMING RESOLUTION (By PC Remote Control Mode)									
Voltage	3mV	3mV	3mV	5mV	5mV	5mV	14mV	14mV	14mV
Current	1mA	2mA	3mA	1mA	1mA	1mA	1mA	1mA	1mA
MEASUREMENT RESOLUTION (By PC Remote Control Mode)									
Voltage	3mV	3mV	3mV	5mV	5mV	5mV	14mV	14mV	14mV
Current	1mA	2mA	3mA	1mA	1mA	1mA	1mA	1mA	1mA
SERIES AND PARALLEL CAPABILITY									
Parallel Operation	Up to 3 units including the master unit			3	3	3	3	3	3
Series Operation	Up to 2 units including the master unit			N/A	N/A	N/A	N/A	N/A	N/A
PROTECTION FUNCTION									
OVP	16~176V	16~176V	16~176V	20~275V	20~275V	20~275V	20~880V	20~880V	20~880V
OCP	0.72~7.92A	1.44~15.84A	2.16~23.76A	0.45~4.95A	0.9~9.9A	1.35~14.85A	0.144~1.584A	0.288~3.168A	0.432~4.752
OHP	Activated by elevated internal temperatures								
FRONT PANEL DISPLAY ACCURACY, 4 digits									
Voltage	0.1%±100mV	0.1%±100mV	0.1%±100mV	0.1%±200mV	0.1%±200mV	0.1%±200mV	0.1%±400mV	0.1%±400mV	0.1%±400mV
Current	0.1%±5mA	0.1%±30mA	0.1%±30mA	0.1%±5mA	0.1%±10mA	0.1%±20mA	0.1%±2mA	0.1%±4mA	0.1%±6mA
ENVIRONMENT CONDITION									
Operation Temp	0°C – 50°C								
Storage Temp	-25°C – 70°C								
Operating Humidity	20% – 85% RH; No condensation								
Storage Humidity	90% RH or Less; No condensation								
READ BACK TEMP COEFFICIENT									
Voltage	100ppm/°C of rated output voltage : after a 30 minute warm-up								
Current	200ppm/°C of rated output current : after a 30 minute warm-up								
OTHER									
Analog Control Interface	Yes								
Interface	USB/LAN/GPIB-USB(Optional)/RS232-USB(Optional)								
Fan	With thermal sensing control								
POWER SOURCE	85VAC~265VAC, 47~63Hz, single phase								
DIMENSIONS & WEIGHT									
	71(W)x124(H) x350(D) mm ; Approx. 3kg	142(W)x124(H) x350(D) mm ; Approx. 5.3kg	214(W)x124(H) x350(D) mm ; Approx. 7.5kg	71(W)x124(H) x350(D) mm ; Approx. 3kg	142(W)x124(H) x350(D) mm ; Approx. 5.3kg	214(W)x124(H) x350(D) mm ; Approx. 7.5kg	71(W)x124(H) x350(D) mm ; Approx. 3kg	142(W)x124(H) x350(D) mm ; Approx. 5.3kg	214(W)x124(H) x350(D) mm ; Approx. 7.5kg

PSW-008



PSW-009



PSW-010



PSW-011



PSW-012





PSW-Series

ORDERING INFORMATION

PSW 30-36	(0-30V/0-36A/360W) Multi-Range DC Power Supply
PSW 30-72	(0-30V/0-72A/720W) Multi-Range DC Power Supply
PSW 30-108	(0-30V/0-108A/1080W) Multi-Range DC Power Supply
PSW 40-27	(0-40V/0-27A/360W) Multi-Range DC Power Supply
PSW 40-54	(0-40V/0-54A/720W) Multi-Range DC Power Supply
PSW 40-81	(0-40V/0-81A/1080W) Multi-Range DC Power Supply
PSW 80-13.5	(0-80V/0-13.5A/360W) Multi-Range DC Power Supply
PSW 80-27	(0-80V/0-27A/720W) Multi-Range DC Power Supply
PSW 80-40.5	(0-80V/0-40.5A/1080W) Multi-Range DC Power Supply
PSW 160-7.2	(0-160V/0-7.2A/360W) Multi-Range DC Power Supply
PSW 160-14.4	(0-160V/0-14.4A/720W) Multi-Range DC Power Supply
PSW 160-21.6	(0-160V/0-21.6A/1080W) Multi-Range DC Power Supply
PSW 250-4.5	(0-250V/0-4.5A/360W) Multi-Range DC Power Supply
PSW 250-9	(0-250V/0-9A/720W) Multi-Range DC Power Supply
PSW 250-13.5	(0-250V/0-13.5A/1080W) Multi-Range DC Power Supply
PSW 800-1.44	(0-800V/0-1.44A/360W) Multi-Range DC Power Supply
PSW 800-2.88	(0-800V/0-2.88A/720W) Multi-Range DC Power Supply
PSW 800-4.32	(0-800V/0-4.32A/1080W) Multi-Range DC Power Supply

ACCESSORIES :

CD-ROM x 1 (Programming Manual, User Manual), GTL-123 Test Lead x 1 (for PSW 30V/40V/80V/160V), Power Cord x 1 (Region dependent), GTL-240 USB Cable " L " Type x 1, PSW-004 Basic Accessories Kit x 1 (for PSW 30V/40V/80V/160V), Includes : M4 Terminal screws and washers x 2, Air Filter x 1, Analog control protection dummy x 1, Analog control lock lever x 1, M8 terminal bolts, nuts and washers x 2

PSW-008	Basic Accessories Kit for PSW 250V/800V models
PSW-009	Output Terminal Cover for 30V/40V/80V/160V models
PSW-011	Output Terminal Cover for 250V/800V models
PSW-012	High Voltage Output Terminal for 250V/800V model

OPTIONAL ACCESSORIES

PSW-001	Accessory Kit	PSW-010	Large filter (Type II/III)
PSW-002	Simple IDC Tool	GTL-248	GPIB Cable, Double Shielded, 2000mm
PSW-003	Contact Removal Tool	GTL-250	GPIB Cable, Double Shielded, 600mm
PSW-005	Cable for 2 Units of PSW-Series in Series Mode Connection (for PSW 30V/40V/80V/160V)	GUR-001A	USB to RS-232 Cable, 300mm (H3)
PSW-006	Cable for 2 Units of PSW-Series in Parallel Mode Connection	GUR-001B	RS-232 to USB Adapter with #4-40 UNC Rivet Nut
PSW-007	Cable for 3 Units of PSW-Series in Parallel Mode Connection	GUG-001	GPIB to USB Adaptor
GET-001	Extended Terminal with max. 30A (for PSW 30V/40V/80V/160V)	GRA-410-J	Rack Mount Kit (JIS)
GET-002	Extended Terminal with max. 10A (for PSW 250V/800V)	GRA-410-E	Rack Mount Kit (EIA)
GET-005	Extended European Terminal with max. 20A (for PSW 30V/40V/80V/160V)		
GTL-130	Test lead : 2 x red, 2 x black (for PSW 250V/800V)		

PSW-Series (LV) Rear Panel



PSW-Series (HV) Rear Panel



GRA-410-J/E Rack Mount Kit (JIS/EIA)

For : PSW-Series



GTL-130 Test lead, 1200mm, 18AWG, UL 3239 (for PSW 250V/800V)



GUR-001A USB to RS-232 Cable (for PSW-Series, 300mm)



GUG-001 GPIB to USB Adapter (for GDS-3000Series, PSW-Series)



GET-001 Extended Terminal (for PSW 30V/40V/80V/160V)



GET-002 Extended Terminal (for PSW 250V/800V)



GET-005 Extended European Terminal (for PSW 30V/40V/80V/160V)



Programmable Switching D.C. Power Supply



PSU-Series



FEATURES

- * Voltage Output : 6V/8V/12.5V/15V/20V/30V/40V/50V/60V/80V/100V/150V/300V/400V/600V
- * Power Output : 1200W ~ 1560W
- * C.V/C.C Priority Mode
- * Adjustable Voltage/Current Rise and Fall Time
- * Series/Parallel Connection : Max. 2 units (Models Under 300V)/4 units of The Same Model
- * High Efficiency and High Power Density
- * 1U Height and 19" Rack Mount Size
- * Three sets of Preset Function
- * Bleeder Control Function
- * Internal Resistance Function
- * Panel Lock Function
- * Protection : OVP, OCP, OHP, UVL, AC Fail, FAN Fail
- * Standard : USB, LAN, RS-232, RS-485, Analog Control
- * Option : GPIB, Isolated Analog Interface (Voltage Control/Current Control)

GW Instek PSU-Series, a DC power supply with high power density design, is 1U in height and compatible with 19" Rack Mount Size. The series is suitable for test system installation or system integration by flexibly selecting models for the integration into the existing test system. The PSU-Series, featuring superior voltage and current control functions, comprises fifteen models with output voltage/current ranging from 6V/200A to 600V/2.6A. The Series is suitable for different test conditions and DUTs, including electronic components testing, micro resistors, relays, shunt resistors, 12V/24V/48V battery simulation, and automotive electronic device testing.

The PSU-HV series is ideal for the primary input of DC/DC converter and servomotor production application. PSU is often integrated into component test systems such as aging test equipment for capacitors; 600V DC bias applications; aging test equipment for diode; semiconductor production equipment; automotive electronics; and ECU for V8 engine or V12 engine, etc.

Utilizing same model units of the PSU-Series to conduct series and parallel connections can increase total output power, total current or total voltage. The wide voltage and current output ranges of the PSU-Series can fully satisfy various voltage and current measurement requirements. The PSU-Series is a single power output DC programmable power supply, which outputs 1200W to 1560W. The PSU-Series provides maximum 2 units in series connection (models under 300V) to achieve maximum 600V or 4 units in parallel connection to obtain maximum 800A and the maximum output power of 6.24 kilowatts.

The PSU-Series allows settings for CC priority or CV priority. Under CC or CV mode, users can adjust slew rate for output voltage or current based upon test requirements. There are two kinds of slew rate settings: high speed priority and slew rate priority. High speed priority sets slew rate at the maximum speed to reach CC or CV mode. Slew rate priority allows users to set slew rate for CC or CV mode in order to control rise or fall slew rate. Slew rate priority mode is ideal for motor tests by adjusting the rise time of output voltage to protect DUT from being damaged by inrush current occurred at turn-on.

Comparing with other 1U power supplies available in the market, PSU supports a most complete array of interfaces, including USB, LAN, RS-232, RS-485, analog control interface, GPIB (option), isolated analog interface (voltage control), and isolated analog interface (current control). Via the multi-drop mode, PSU will not need any switch/hub and GPIB cable for remote control and slave unit augmentation when using LAN, USB or GPIB. This feature can help users save costs on augmentation equipment for connecting slave while using LAN or USB.

The PSU-Series provides users with flexible settings of High/Low Level or Trigger input/Trigger output signals with pulse width of 1 ~ 60ms. Trigger input controls PSU to output or upload preset voltage, current and memory parameters. While outputting or uploading preset voltage, current and memory parameters PSU can produce corresponding Trigger output signals.

PSU-Series Model Selection Table

1.5kW 1U High	6-200	8-180	12.5-120	15-100	20-76	30-50	40-38	50-30	60-25	80-19	100-15	150-10	300-5	400-3.8	600-2.6
Voltage	6,000 V	8,000 V	12.50 V	15.00 V	20.00 V	30.00 V	40.00 V	50.00 V	60.00 V	80.00 V	100.0 V	150.0 V	300.0 V	400.0 V	600.0 V
Current	200.0 A	180.0 A	120.0 A	100.0 A	76.00 A	50.00 A	38.00 A	30.0 A	25.00 A	19.00 A	15.00 A	10.00 A	5.000 A	3.800 A	2.600 A
Power	1200 W	1440 W	1500 W	1500 W	1520 W	1500 W	1520 W	1500 W	1500 W	1520 W	1500 W	1500 W	1500 W	1520 W	1560 W
3kW 2U High	6-400(B)	8-360(B)	12.5-240(B)	15-200(B)	20-152(B)	30-100(B)	40-76(B)	50-60(B)	60-50(B)	80-38(B)	100-30(B)	150-20(B)	300-10(B)	400-7.6(B)	600-5.2(B)
Voltage	6,000 V	8,000 V	12.50 V	15.00 V	20.00 V	30.00 V	40.00 V	50.00 V	60.00 V	80.00 V	100.0 V	150.0 V	300.0 V	400.0 V	600.0 V
Current	400.0 A	360.0 A	240.0 A	200.0 A	152.0 A	100.0 A	76.00 A	60.00 A	50.00 A	38.00 A	30.00 A	20.00 A	10.00 A	7.600 A	5.200 A
Power	2400 W	2880 W	3000 W	3000 W	3040 W	3000 W	3040 W	3000 W	3000 W	3040 W	3000 W	3000 W	3000 W	3040 W	3120 W
4.5kW 3U High	6-600(B)	8-540(B)	12.5-360(B)	15-300(B)	20-228(B)	30-150(B)	40-114(B)	50-90(B)	60-75(B)	80-57(B)	100-45(B)	150-30(B)	300-15(B)	400-11.4(B)	600-7.8(B)
	6-600(C)	8-540(C)	12.5-360(C)	15-300(C)	20-228(C)	30-150(C)	40-114(C)	50-90(C)	60-75(C)	80-57(C)	100-45(C)	150-30(C)	300-15(C)	400-11.4(C)	600-7.8(C)
	6-600(D)	8-540(D)	12.5-360(D)	15-300(D)	20-228(D)	30-150(D)	40-114(D)	50-90(D)	60-75(D)	80-57(D)	100-45(D)	150-30(D)	300-15(D)	400-11.4(D)	600-7.8(D)
Voltage	6,000 V	8,000 V	12.50 V	15.00 V	20.00 V	30.00 V	40.00 V	50.00 V	60.00 V	80.00 V	100.0 V	150.0 V	300.0 V	400.0 V	600.0 V
Current	600.0 A	540.0 A	360.0 A	300.0 A	228.0 A	150.0 A	114.0 A	90.0 A	75.00 A	57.00 A	45.00 A	30.00 A	15.00 A	11.40 A	7.800 A
Power	3600 W	4320 W	4500 W	4500 W	4560 W	4500 W	4560 W	4500 W	4500 W	4560 W	4500 W	4500 W	4500 W	4560 W	4680 W
6kW 4U High	6-800(B)	8-720(B)	12.5-480(B)	15-400(B)	20-304(B)	30-200(B)	40-152(B)	50-120(B)	60-100(B)	80-76(B)	100-60(B)	150-40(B)	300-20(B)	400-15.2(B)	600-10.4(B)
	6-800(C)	8-720(C)	12.5-480(C)	15-400(C)	20-304(C)	30-200(C)	40-152(C)	50-120(C)	60-100(C)	80-76(C)	100-60(C)	150-40(C)	300-20(C)	400-15.2(C)	600-10.4(C)
	6-800(D)	8-720(D)	12.5-480(D)	15-400(D)	20-304(D)	30-200(D)	40-152(D)	50-120(D)	60-100(D)	80-76(D)	100-60(D)	150-40(D)	300-20(D)	400-15.2(D)	600-10.4(D)
Voltage	6,000 V	8,000 V	12.50 V	15.00 V	20.00 V	30.00 V	40.00 V	50.00 V	60.00 V	80.00 V	100.0 V	150.0 V	300.0 V	400.0 V	600.0 V
Current	800.0 A	720.0 A	480.0 A	400.0 A	304.0 A	200.0 A	152.0 A	120.0 A	100.0 A	76.0 A	60.00 A	40.00 A	20.00 A	15.20 A	10.40 A
Power	4800 W	5760 W	6000 W	6000 W	6080 W	6000 W	6080 W	6000 W	6000 W	6080 W	6000 W	6000 W	6000 W	6080 W	6240 W

Note: B: Input voltage 170~265VAC, single phase; C: Input voltage 180~253VAC, three-phase three-wire; D: Input voltage 360~440VAC, three-phase four-wire; No CE certificate.

SPECIFICATIONS

Model	PSU	6-200	8-180	12.5-120	15-100	20-76	30-50	40-38	50-30	60-25	80-19	100-15	150-10	300-5	400-3.8	600-2.6	
Rated output voltage (*)	V	6	8	12.5	15	20	30	40	50	60	80	100	150	300	400	600	
Rated output current (**)	A	200	180	120	100	76	50	38	30	25	19	15	10	5	3.8	2.6	
Rated output power	W	1200	1440	1500	1500	1520	1500	1520	1500	1500	1520	1500	1500	1500	1520	1560	
Constant Voltage Mode	PSU	6-200	8-180	12.5-120	15-100	20-76	30-50	40-38	50-30	60-25	80-19	100-15	150-10	300-5	400-3.8	600-2.6	
Line regulation (**3)	mV	2.6	2.8	3.25	3.5	4	5	6	7	8	10	12	17	32	42	62	
Load regulation (**4)	mV	2.6	2.8	3.25	3.5	4	5	6	7	8	10	12	17	32	42	62	
Ripple and noise (**5)	p-p (**6)	mV	60	60	60	60	60	60	60	60	80	80	100	150	200	300	
	r.m.s. (**7)	mV	8	8	8	8	8	8	8	8	8	8	8	10	25	40	60
Temperature coefficient	ppm/°C	100ppm/°C after a 30 minute warm-up															
Remote sense compensation voltage (single wire)	V	1	1	1	1	1	1.5	2	2	3	4	5	5	5	5	5	
Rise time (**8)	Rated load	ms	80	80	80	80	80	80	80	80	150	150	150	150	200	250	
	No load	ms	80	80	80	80	80	80	80	80	150	150	150	150	200	250	
Fall time (**9)	Rated load	ms	10	50	50	50	50	80	80	80	150	150	150	150	200	250	
	No load	ms	500	600	700	700	800	900	1000	1100	1200	1500	2000	2500	3000	4000	
Transient response time (**10)	ms	1.5	1.5	1	1	1	1	1	1	1	1	1	2	2	2	2	
Constant Current Mode	PSU	6-200	8-180	12.5-120	15-100	20-76	30-50	40-38	50-30	60-25	80-19	100-15	150-10	300-5	400-3.8	600-2.6	
Line regulation (**3)	mA	22	20	14	12	9.6	7	5.8	5	4.5	3.9	3.5	3	2.5	2.38	2.26	
Load regulation (**11)	mA	45	41	29	25	20.2	15	12.6	11	10	8.8	8	7	6	5.76	5.52	
Ripple and noise (**12)	r.m.s.	mA	400	360	240	200	152	125	95	85	75	57	45	35	25	17	12
Temperature coefficient	ppm/°C	100ppm/°C after a 30 minute warm-up															
Protection Function	PSU	6-200	8-180	12.5-120	15-100	20-76	30-50	40-38	50-30	60-25	80-19	100-15	150-10	300-5	400-3.8	600-2.6	
Over voltage protection (OVP)	Setting range	V	0.6 - 6.6	0.8-8.8	1.25 - 13.75	1.5 - 16.5	2 - 22	3 - 33	4 - 44	5 - 55	5 - 66	5 - 88	5 - 110	5 - 165	5 - 330	5 - 440	5 - 660
	Setting accuracy	mV	60	80	125	150	200	300	400	500	600	800	1000	1500	3000	4000	6000
Over current protection (OCP)	Setting range	A	5 - 220	5-198	5 - 132	5 - 110	5 - 83.6	5 - 55	3.8 - 41.8	3 - 33	2.5 - 27.5	1.9 - 20.9	1.5 - 16.5	1 - 11	0.5 - 5.5	0.38 - 4.18	0.26 - 2.86
	Setting accuracy	mA	4000	3600	2400	2000	1520	1000	760	600	500	380	300	200	100	76	52
Under voltage limit (UVL)	Setting range	V	0 - 6.3	0 - 8.4	0 - 13.12	0 - 15.75	0 - 21	0 - 31.5	0 - 42	0 - 52.5	0 - 63	0 - 84	0 - 105	0 - 157.5	0 - 315	0 - 420	0 - 630
Over temperature protection (OHP)	Operation	Turn the output off.															
Incorrect sensing connection protection (SENSE)	Operation	Turn the output off.															
Low AC input protection (AC-FAIL)	Operation	Turn the output off.															
Shutdown (SD)	Operation	Turn the output off.															
Power limit (POWER LIMIT)	Operation	Over power limit.															
Analog Programming and Monitoring	PSU	6-200	8-180	12.5-120	15-100	20-76	30-50	40-38	50-30	60-25	80-19	100-15	150-10	300-5	400-3.8	600-2.6	
External voltage control output voltage	Accuracy and linearity: ±0.5% of rated output voltage.																
External voltage control output current	Accuracy and linearity: ±1% of rated output current.																
External resistor control output voltage	Accuracy and linearity: ±1% of rated output voltage.																
External resistor control output current	Accuracy and linearity: ±1.5% of rated output current.																
Output voltage monitor	Accuracy: ±1%																
Output current monitor	Accuracy: ±1%																
Shutdown control	Turns the output off with a LOW (0V to 0.5V) or short-circuit.																
Output on/off control	Possible logic selections: Turn the output on using a LOW (0V to 0.5V) or short-circuit, turn the output off using a HIGH (4.5V to 5V) or open-circuit. Turn the output on using a HIGH (4.5V to 5V) or open-circuit, turn the output off using a LOW (0V to 0.5V) or short-circuit.																
Alarm clear control	Clear alarms with a LOW (0V to 0.5V) or short-circuit.																
CV/CC/ALM/PWR ON/OUT ON indicator	Photocoupler open collector output; Maximum voltage 30V, maximum sink current 8mA.																
Trigger out	Maximum low level output = 0.8V; minimum high level output = 2V; Maximum source current = 8mA.																
Trigger in	Maximum low level input voltage = 0.8V; minimum high level input voltage = 2V, Maximum sink current = 8mA.																
Front Panel	PSU	6-200	8-180	12.5-120	15-100	20-76	30-50	40-38	50-30	60-25	80-19	100-15	150-10	300-5	400-3.8	600-2.6	
Display, 4 digits	Voltage accuracy	0.1% +	mV	12	16	25	30	40	60	80	100	120	160	200	300	600	1200
	Current accuracy	0.2% +	mA	600	540	360	300	228	150	114	90	75	57	45	30	15	11.4
Indications	GREEN LED's: CV, CC, V, A, VSR, ISR, DLY, RMT, LAN, M1, M2, M3, RUN, Output ON; RED LED's: ALM, ERR																
Buttons	Lock/Local(Unlock), PROT(ALM_CLR), Function(M1), Test(M2), Set(M3), Shift, Output																
Knobs	Voltage, Current																
USB port	Type A USB connector																
Programming and Measurement (RS-232/485, USB, LAN, GPIB)	PSU	6-200	8-180	12.5-120	15-100	20-76	30-50	40-38	50-30	60-25	80-19	100-15	150-10	300-5	400-3.8	600-2.6	
Output voltage programming accuracy	0.05% +	mV	3	4	6.25	7.5	10	15	20	25	30	40	50	75	150	200	300
Output current programming accuracy	0.2% +	mA	200	180	120	100	76	50	38	30	25	19	15	10	5	3.8	2.6
Output voltage programming resolution		mV	0.2	0.27	0.4	0.5	0.7	1	1.3	1.7	2	2.7	3.4	5.2	10.2	13.6	20.4
Output current programming resolution		mA	6	6	4	3.3	2.5	1.7	1.2	1	0.8	0.65	0.5	0.34	0.19	0.13	0.09
Output voltage measurement accuracy	0.1% +	mV	6	8	12.5	15	20	30	40	50	60	80	100	150	300	400	600
Output current measurement accuracy	0.2% +	mA	400	360	240	200	152	100	76	60	50	38	30	20	10	7.6	5.2
Output voltage measurement resolution		mV	0.2	0.27	0.4	0.5	0.7	1	1.3	1.7	2	2.7	3.4	5.2	10.2	13.6	20.4
Output current measurement resolution		mA	6	6	4	3.3	2.5	1.7	1.2	1	0.8	0.65	0.5	0.34	0.19	0.13	0.09
Input Characteristics	PSU	6-200	8-180	12.5-120	15-100	20-76	30-50	40-38	50-30	60-25	80-19	100-15	150-10	300-5	400-3.8	600-2.6	
Normal input rating	100Vac ~ 240Vac, 50Hz ~ 60Hz, single phase																
Input voltage range	85Vac ~ 265Vac																
Input frequency range	47Hz ~ 63Hz																
Maximum input current	100Vac / 200Vac	A	21 / 11														
Inrush current	Less than 50A																
Maximum input power	VA	2000															
Power factor	100Vac / 200Vac	0.99 / 0.98															
Efficiency (**13)	100Vac / 200Vac	%	76.5 / 79	78/81	82 / 85	82 / 85	83 / 86	83 / 86	84 / 87	84 / 87	84 / 87	84 / 87	84 / 87	84 / 87	84 / 87	84 / 87	84 / 87
Hold-up time	20ms or greater																
Interface Capabilities	PSU	6-200	8-180	12.5-120	15-100	20-76	30-50	40-38	50-30	60-25	80-19	100-15	150-10	300-5	400-3.8	600-2.6	
USB	TypeA: Host, TypeB: Slave, Speed: 1.1/2.0, USB Class: CDC(Communications Device Class)																
LAN	MAC Address, DNS IP Address, User Password, Gateway IP Address, Instrument IP Address, Subnet Mask																
RS-232 / RS-485	Complies with the EIA232D / EIA485 Specifications																
GPIB (Factory Option)	SCPI - 1993, IEEE 488.2 compliant interface																
Isolated Analog Control Interface (Factory Option)	PSU	6-200	8-180	12.5-120	15-100	20-76	30-50	40-38	50-30	60-25	80-19	100-15	150-10	300-5	400-3.8	600-2.6	
Voltage Control	Using 0-5V or 0 - 10V signals for programming and measurement																
Current Control	Using 4 - 20mA current signals for programming and measurement																
Environmental Conditions	PSU	6-200	8-180	12.5-120	15-100	20-76	30-50	40-38	50-30	60-25	80-19	100-15	150-10	300-5	400-3.8	600-2.6	
Operating temperature	0 °C ~ 50 °C (**14)																
Storage temperature	-25 °C ~ 70 °C																
Operating humidity	20% ~ 85% RH; No condensation																
Storage humidity	90% RH or less; No condensation																
Altitude	Maximum 2000m																
General Specifications	PSU	6-200	8-180	12.5-120	15-100	20-76	30-50	40-38	50-30	60-25	80-19	100-15	150-10	300-5	400-3.8	600-2.6	
Weight	main unit only	kg	Less than 8.7kg														
Dimensions	(W×H×D)	mm	423 × 43.6 × 447.2														
Cooling	Forced air cooling by internal fan.																
EMC	Complies with the European EMC directive 89/336/EEC for Class A test and measurement products.																
Safety	Complies with the European Low Voltage Directive 73/23/EEC and carries the CE-marking.																
Withstand voltage	AC to Chassis : 1500Vac/1min; AC to Output terminal : 3000Vac/1min; Vout ≤ 150V; Output terminal to Chassis : 1000Vdc/1min; 150-Vout ≤ 600; Output terminal to Chassis : 1500Vdc/1min																
Insulation resistance	Chassis and output terminal; chassis and AC input; AC input and output terminal: 100MΩ or more (DC 1000V)																

Notes:
 (*1) Minimum voltage is guaranteed to maximum 0.2% of the rated output voltage.
 (*2) Minimum current is guaranteed to maximum 0.4% of the rated output current.
 (*3) At 85 ~ 132Vac or 170 ~ 265Vac, constant load.
 (*4) From No-load to Full-load, constant input voltage. Measured at the sensing point in Remote Sense.
 (*5) Measure with JEITA RC-9131B (1:1) probe
 (*6) Measurement frequency bandwidth is 10Hz ~ 20MHz.
 (*7) Measurement frequency bandwidth is 5Hz ~ 1MHz.
 (*8) From 10% ~ 90% of rated output voltage, with rated resistive load.
 (*9) From 90% ~ 10% of rated output voltage, with rated resistive load.
 (*10) Time for output voltage to recover within 0.5% of its rated output for a load change from 10 ~ 90% of its rated output current. Voltage set point from 10% ~ 100% of rated output.
 (*11) For load voltage change, equal to the unit voltage rating, constant input voltage.
 (*12) For 6V ~ 20V model the ripple is measured at 2V ~ rated output voltage and full output current. For other models, the ripple is measured at 10 ~ 100% output voltage and full output current.
 (*13) At rated output power.
 (*14) If install the front panel filter kit, the temperature is guaranteed to 40 °C.

Programmable Switching D.C. Power Supply

SPECIFICATIONS

Model		PSU	6-400	8-360	12.5-240	15-200	20-152	30-100	40-76	50-60	60-50	80-38	100-30	150-20	300-10	400-7.6	600-5.2		
Rated output voltage ^{(*)1}		V	6	8	12.5	15	20	30	40	50	60	80	100	150	300	400	600		
Rated output current ^{(*)2}		A	400	360	240	200	152	100	76	60	50	38	30	20	10	7.6	5.2		
Rated output power		W	2400	2880	3000	3000	3040	3000	3040	3000	3000	3040	3000	3000	3000	3040	3120		
Constant Voltage Mode		PSU	6-400	8-360	12.5-240	15-200	20-152	30-100	40-76	50-60	60-50	80-38	100-30	150-20	300-10	400-7.6	600-5.2		
Line regulation ^{(*)3}		mV	0.01% of rated output voltage +2mV																
Load regulation ^{(*)4}		mV	0.01% of rated output voltage +5mV																
Ripple and noise ^{(*)5}	p-p ^{(*)6}	mV	75	75	75	75	75	75	75	75	75	100	100	120	300	300	500		
	r.m.s. ^{(*)7}	mV	10	10	10	10	10	10	10	10	10	15	15	25	35	35	120		
Temperature coefficient		ppm/°C	100ppm/°C after a 30 minute warm-up																
Temperature stability			0.05% of rated output voltage over 8hrs interval following 30 minutes warm-up. Constant line, load & temp.																
Warm-up drift			Less than 0.05% of rated output voltage +2mV over 30 minutes following power on.																
Remote sense compensation voltage (single wire)		V	1	1	1	1	1	1.5	2	2	3	4	5	5	5	5	5		
Rise time ^{(*)8}	No load	ms	80	80	80	80	80	80	80	80	80	150	150	150	150	200	250		
Fall time ^{(*)9}	Rated load	ms	10	50	50	50	50	80	80	80	80	150	150	150	150	200	250		
	No load	ms	500	600	700	700	800	900	1000	1100	1100	1200	1500	2000	2500	3000	4000		
Transient response time ^{(*)10}		ms	3	3	3	3	3	3	3	3	3	3	3	3	3	3	3		
Constant Current Mode		PSU	6-400	8-360	12.5-240	15-200	20-152	30-100	40-76	50-60	60-50	80-38	100-30	150-20	300-10	400-7.6	600-5.2		
Line regulation ^{(*)3}		mA	0.05% of rated output current																
Load regulation ^{(*)11}		mA	0.5% of rated output current												1% of rated output current				
Load regulation thermal drift			Less than 0.1% of rated output current over 30 minutes following load change.																
Ripple and noise ^{(*)12}	r.m.s.	mA	850	800	650	590	520	290	185	137	107	85	69	58	30	20	15		
Temperature coefficient		ppm/°C	100ppm/°C after a 30 minute warm-up																
Temperature stability			0.05% of rated output current over 8hrs interval following 30 minutes warm-up. Constant line, load & temp.																
Warm-up drift			6-15V model: Less than 0.5% rated output current over 30 minutes following power on; 20-600V model: Less than 0.25% rated output current over 30 minutes following power on.																
Protection Function		PSU	6-400	8-360	12.5-240	15-200	20-152	30-100	40-76	50-60	60-50	80-38	100-30	150-20	300-10	400-7.6	600-5.2		
Over voltage protection (OVP)	Setting range	V	0.6 - 6.6	0.8-8.8	1.25 - 13.75	1.5 - 16.5	2 - 22	3 - 33	4 - 44	5 - 55	5 - 66	5 - 88	5 - 110	5 - 165	5 - 330	5 - 440	5 - 660		
	Setting accuracy	mV	60	80	125	150	200	300	400	500	600	800	1000	1500	3000	4000	6000		
Over current protection (OCP)	Setting range	A	5 - 440	5-396	5 - 262	5 - 220	5 - 167.2	5 - 110	5 - 83.6	5 - 66	5 - 55	3.8 - 41.8	3 - 33	2 - 22	1 - 11	0.76 - 8.36	0.52 - 5.72		
	Setting accuracy	A	8	7.2	4.8	4	3.04	2	1.52	1.2	1	0.76	0.6	0.4	0.2	0.152	0.104		
Under voltage limit (UVL)	Setting range		0 - 6.3	0 - 8.4	0 - 13.12	0 - 15.75	0 - 21	0 - 31.5	0 - 42	0 - 52.5	0 - 63	0 - 84	0 - 105	0 - 157.5	0 - 315	0 - 420	0 - 630		
Over temperature protection (OHP)	Operation		Turn the output off.																
Incorrect sensing connection protection (SENSE)	Operation		Turn the output off.																
Low AC input protection (AC-FAIL)	Operation		Turn the output off.																
Shutdown (SD)	Operation		Turn the output off.																
Power limit (POWER LIMIT)	Operation		Over power limit.																
	Value (fixed)		Approx. 105% of rated output power																
Front Panel		PSU	6-400	8-360	12.5-240	15-200	20-152	30-100	40-76	50-60	60-50	80-38	100-30	150-20	300-10	400-7.6	600-5.2		
Display, 4 digits	Voltage accuracy	mV	12	16	25	30	40	60	80	100	120	160	200	300	600	800	1200		
	Current accuracy	mA	1200	1080	720	600	456	300	228	180	150	114	90	60	30	22.8	15.6		
Indications			GREEN LED's: CV, CC, V, A, VSR, ISR, DLY, RMT, LAN, M1, M2, M3, RUN, Output ON; RED LED's: ALM, ERR																
Buttons			Lock/Local(Unlock), PROT(ALM_CLR), Function(M1), Test(M2), Set(M3), Shift, Output																
Knobs			Voltage, Current																
USB port			Type A USB connector																
Programming and Measurement (RS-232/485, USB, LAN, GPIB)		PSU	6-400	8-360	12.5-240	15-200	20-152	30-100	40-76	50-60	60-50	80-38	100-30	150-20	300-10	400-7.6	600-5.2		
Output voltage programming accuracy	0.05% +	mV	3	4	6.25	7.5	10	15	20	25	30	40	50	75	150	200	300		
Output current programming accuracy	0.2% +	mA	400	360	240	200	152	100	76	60	50	38	30	20	10	7.6	5.2		
Output voltage programming resolution		mV	0.2	0.27	0.4	0.5	0.7	1	1.3	1.7	2	2.7	3.4	5.2	10.2	13.6	20.4		
Output current programming resolution		mA	12	12	8	6.6	5	3.4	2.4	2	1.6	1.3	1	0.68	0.38	0.26	0.18		
Output voltage measurement accuracy	0.1% +	mV	6	8	12.5	15	20	30	40	50	60	80	100	150	300	400	600		
Output current measurement accuracy	0.2% +	mA	800	720	480	400	304	200	152	120	100	76	60	40	20	15.2	10.4		
Output voltage measurement resolution		mV	0.2	0.27	0.4	0.5	0.7	1	1.3	1.7	2	2.7	3.4	5.2	10.2	13.6	20.4		
Output current measurement resolution		mA	12	12	8	6.6	5	3.4	2.4	2	1.6	1.3	1	0.68	0.38	0.26	0.18		
Input Characteristics		PSU	6-400	8-360	12.5-240	15-200	20-152	30-100	40-76	50-60	60-50	80-38	100-30	150-20	300-10	400-7.6	600-5.2		
Normal input rating			B type: 1P2W 200V models																
Input voltage range			B type: 1P2W 170 - 265Vac																
Input frequency range			47Hz - 63Hz																
Maximum input current	200Vac	A	B type: 22A																
Inrush current			B type: 1P2W 200V models Less than 100A.																
Power factor	200Vac		0.98 @1 Phase 200Vac																
Efficiency ^{(*)13}		%	78.5	81	85	85	86	86	87	87	87	87	87	87	87	87	87		
Hold-up time			20ms or greater																
Interface Capabilities		PSU	6-400	8-360	12.5-240	15-200	20-152	30-100	40-76	50-60	60-50	80-38	100-30	150-20	300-10	400-7.6	600-5.2		
USB			TypeA: Host, TypeB: Slave, Speed: 1.1/2.0, USB Class: CDC(Communications Device Class)																
LAN			MAC Address, DNS IP Address, User Password, Gateway IP Address, Instrument IP Address, Subnet Mask																
RS-232 / RS-485			Complies with the EIA232D / EIA485 Specifications																
GPIB (Factory Option)			SCPI - 1993, IEEE 488.2 compliant interface																
Environmental Conditions		PSU	6-400	8-360	12.5-240	15-200	20-152	30-100	40-76	50-60	60-50	80-38	100-30	150-20	300-10	400-7.6	600-5.2		
Operating temperature			0 °C - 50 °C ^{(*)14}																
Storage temperature			-25 °C - 70 °C																
Operating humidity			20% - 85% RH; No condensation																
Storage humidity			90% RH or less; No condensation																
Altitude			Maximum 2000m																
General Specifications		PSU	6-400	8-360	12.5-240	15-200	20-152	30-100	40-76	50-60	60-50	80-38	100-30	150-20	300-10	400-7.6	600-5.2		
Weight	main unit only	kg	Less than 20kg																
Dimensions	[WxHxD]	mm	423 x 87.2 x 447.2																
Cooling			Forced air cooling by internal fan.																
Withstand voltage			AC to Chassis:500Vac/1min; AC to Output terminal:3000Vac/1min; Vout ≤ 150V; Output terminal to Chassis:1000Vdc/1min; 150<Vout ≤ 600; Output terminal to Chassis: 1500Vdc/1min																
Insulation resistance			Chassis and output terminal, chassis and AC input; AC input and output terminal: 100MΩ or more (DC 1000V)																

Notes:

^{(*)1} Minimum voltage is guaranteed to maximum 0.2% of the rated output voltage.

^{(*)2} Minimum current is guaranteed to maximum 0.4% of the rated output current.

^{(*)3} Single phase 200V models: 170 - 265Vac.

^{(*)4} From No-load to Full-load, constant input voltage. Measured at the sensing point in Remote Sense.

^{(*)5} Measured at rated output voltage and current with JEITA RC-9131B probe.

^{(*)6} Measurement frequency bandwidth is 10Hz - 20MHz.

^{(*)7} Measurement frequency bandwidth is 5Hz - 1MHz.

^{(*)8} From 10% - 90% of rated output voltage, with rated resistive load.

^{(*)9} From 90% - 10% of rated output voltage, with rated resistive load.

^{(*)10} Time for output voltage to recover within 2% of its rated output for a load change from 50 to 100% of its rated output current. Voltage set point from 10% - 100% of rated output.

^{(*)11} For load voltage change, equal to the unit voltage rating, constant input voltage.

^{(*)12} For 6V - 20V model the ripple is measured at 2V - rated output voltage and full output current. For other models, the ripple is measured at 10 - 100% output voltage and full output current.

^{(*)13} At rated output power.

^{(*)14} If install the front panel filter kit, the temperature is guaranteed to 40 °C.

SPECIFICATIONS

Model		PSU	6-600	8-540	12.5-360	15-300	20-228	30-150	40-114	50-90	60-75	80-57	100-45	150-30	300-15	400-11.4	600-7.8
Rated output voltage (*)		V	6	8	12.5	15	20	30	40	50	60	80	100	150	300	400	600
Rated output current (*)		A	600	540	360	300	228	150	114	90	75	57	45	30	15	11.4	7.8
Rated output power		W	3600	4320	4500	4500	4560	4500	4560	4500	4500	4560	4500	4500	4500	4560	4680
Constant Voltage Mode		PSU	6-600	8-540	12.5-360	15-300	20-228	30-150	40-114	50-90	60-75	80-57	100-45	150-30	300-15	400-11.4	600-7.8
Line regulation (*)		mV	0.01% of rated output voltage +2mV														
Load regulation (*)		mV	0.01% of rated output voltage +5mV														
Ripple and noise (*)	p-p (*)	mV	75	75	75	75	75	75	75	75	75	100	100	120	300	300	500
	r.m.s. (*)	mV	10	10	10	10	10	10	10	10	10	15	15	25	35	35	120
Temperature coefficient		ppm/°C	100ppm/°C after a 30 minute warm-up														
Temperature stability			0.05% of rated output voltage over 8hrs interval following 30 minutes warm-up. Constant line, load & temp.														
Warm-up drift			Less than 0.05% of rated output voltage +2mV over 30 minutes following power on.														
Remote sense compensation voltage (single wire)		V	1	1	1	1	1	1.5	2	2	3	4	5	5	5	5	5
Rise time (*)	No load	ms	80	80	80	80	80	80	80	80	80	150	150	150	150	200	250
Fall time (*)	Rated load	ms	10	50	50	50	50	80	80	80	80	150	150	150	150	200	250
	No load	ms	500	600	700	700	800	900	1000	1100	1100	1200	1500	2000	2500	3000	4000
Transient response time (*)		ms	3	3	3	3	3	3	3	3	3	3	3	3	3	3	3
Constant Current Mode		PSU	6-600	8-540	12.5-360	15-300	20-228	30-150	40-114	50-90	60-75	80-57	100-45	150-30	300-15	400-11.4	600-7.8
Line regulation (*)		mA	0.1% of rated output current														
Load regulation (*)		mA	0.5% of rated output current														
Load regulation thermal drift			Less than 0.1% of rated output current over 30 minutes following load change.														
Ripple and noise (*)	r.m.s.	mA	1400	1315	1060	987	900	472	275	191	138	110	92	81	30	20	15
Temperature coefficient		ppm/°C	100ppm/°C after a 30 minute warm-up														
Temperature stability			0.05% of rated output current over 8hrs interval following 30 minutes warm-up. Constant line, load & temp.														
Warm-up drift			6-15V model : Less than 0.5% rated output current over 30 minutes following power on. 20-600V model : Less than 0.25% rated output current over 30 minutes following power on.														
Protection Function		PSU	6-600	8-540	12.5-360	15-300	20-228	30-150	40-114	50-90	60-75	80-57	100-45	150-30	300-15	400-11.4	600-7.8
Over voltage protection (OVP)	Setting range	V	0.6 - 6.6	0.8-8.8	1.25 - 13.75	1.5 - 16.5	2 - 22	3 - 33	4 - 44	5 - 55	5 - 66	5 - 88	5 - 110	5 - 165	5 - 330	5 - 440	5 - 660
	Setting accuracy	mV	60	80	125	150	200	300	400	500	600	800	1000	1500	3000	4000	6000
Over current protection (OCP)	Setting range	A	5 - 660	5-594	5 - 396	5 - 330	5 - 250.8	5 - 165	5 - 125.4	5 - 99	5 - 82.5	5 - 62.7	4.5 - 49.5	3 - 33	1.5 - 16.5	1.14 - 12.54	0.78 - 8.58
	Setting accuracy	A	12	10.8	7.2	6	4.56	3	2.28	1.8	1.5	1.04	0.9	0.6	0.3	0.228	0.156
Under voltage limit (UVL)	Setting range		0 - 6.3	0 - 8.4	0 - 13.12	0 - 15.75	0 - 21	0 - 31.5	0 - 42	0 - 52.5	0 - 63	0 - 84	0 - 105	0 - 157.5	0 - 315	0 - 420	0 - 630
Over temperature protection (OHP)	Operation		Turn the output off.														
Incorrect sensing connection protection (SENSE)	Operation		Turn the output off.														
Low AC input protection (AC-FAIL)	Operation		Turn the output off.														
Shutdown (SD)	Operation		Turn the output off.														
Power limit (POWER LIMIT)	Operation		Over power limit.														
	Value (fixed)		Approx. 105% of rated output power														
Front Panel		PSU	6-600	8-540	12.5-360	15-300	20-228	30-150	40-114	50-90	60-75	80-57	100-45	150-30	300-15	400-11.4	600-7.8
Display, 4 digits	Voltage accuracy	0.1% +	mV	12	16	25	30	40	60	80	100	120	160	200	300	600	1200
	Current accuracy	0.2% +	mA	1800	1620	1080	900	684	450	342	270	225	171	135	90	45	34.2
Indications			GREEN LED's: CV, CC, V, A, VSR, ISR, DLY, RMT, LAN, M1, M2, M3, RUN, Output ON; RED LED's: ALM, ERR														
Buttons			Lock/Local(Unlock), PROT(ALM_CLR), Function(M1), Test(M2), Set(M3), Shift, Output														
Knobs			Voltage, Current														
USB port			Type A USB connector														
Programming and Measurement (RS-232/485, USB, LAN, GPIB)		PSU	6-600	8-540	12.5-360	15-300	20-228	30-150	40-114	50-90	60-75	80-57	100-45	150-30	300-15	400-11.4	600-7.8
Output voltage programming accuracy	0.05% +	mV	3	4	6.25	7.5	10	15	20	25	30	40	50	75	150	200	300
Output current programming accuracy	0.2% +	mA	600	540	360	300	228	150	114	90	75	57	45	30	15	11.4	7.8
Output voltage programming resolution		mV	0.2	0.27	0.4	0.5	0.7	1	1.3	1.7	2	2.7	3.4	5.2	10.2	13.6	20.4
Output current programming resolution		mA	18	18	12	9.9	7.5	5.1	3.6	3	2.4	1.95	1.5	1.02	0.57	0.39	0.27
Output voltage measurement accuracy	0.1% +	mV	6	8	12.5	15	20	30	40	50	60	80	100	150	300	400	600
Output current measurement accuracy	0.2% +	mA	1200	1080	720	600	456	300	228	180	150	114	90	60	30	22.8	15.6
Output voltage measurement resolution		mV	0.2	0.27	0.4	0.5	0.7	1	1.3	1.7	2	2.7	3.4	5.2	10.2	13.6	20.4
Output current measurement resolution		mA	18	18	12	9.9	7.5	5.1	3.6	3	2.4	1.95	1.5	1.02	0.57	0.39	0.27
Input Characteristics		PSU	6-600	8-540	12.5-360	15-300	20-228	30-150	40-114	50-90	60-75	80-57	100-45	150-30	300-15	400-11.4	600-7.8
Normal input rating			B type : 1P2W 200V models, C type : 3P3W 200V models, D type : 3P4W 400V models														
Input voltage range			B type : 1P2W 170 - 265Vac, C type : 3P3W 180 - 253Vac, D type : 3P4W 360 - 440Vac														
Input frequency range			47Hz ~ 63Hz														
Maximum input current	200Vac / 400Vac	A	B type : 33A - C type : 19A - D type 11A														
Inrush current			B type : 1P2W 200V models Less than 150A; C type : 3P3W 200V model Less than 100A; D type : 3P4W 400V model Less than 50A.														
Power factor	200Vac / 400Vac		0.98 @1 Phase 200Vac / 0.95 @ 3 Phase 200/400Vac														
Efficiency (*)		%	78.5	81	85	85	86	86	87	87	87	87	87	87	87	87	87
Hold-up time			20ms or greater														
Interface Capabilities		PSU	6-600	8-540	12.5-360	15-300	20-228	30-150	40-114	50-90	60-75	80-57	100-45	150-30	300-15	400-11.4	600-7.8
USB			TypeA: Host, TypeB: Slave, Speed: 1.1/2.0, USB Class : CDC(Communications Device Class)														
LAN			MAC Address, DNS IP Address, User Password, Gateway IP Address, Instrument IP Address, Subnet Mask														
RS-232 / RS-485			Complies with the EIA232D / EIA485 Specifications														
GPIB (Factory Option)			SCPI - 1993, IEEE 488.2 compliant interface														
Environmental Conditions		PSU	6-600	8-540	12.5-360	15-300	20-228	30-150	40-114	50-90	60-75	80-57	100-45	150-30	300-15	400-11.4	600-7.8
Operating temperature			0 °C ~ 50 °C (*)														
Storage temperature			-25 °C ~ 70 °C														
Operating humidity			20% ~ 85% RH; No condensation														
Storage humidity			90% RH or less; No condensation														
Altitude			Maximum 2000m														
General Specifications		PSU	6-600	8-540	12.5-360	15-300	20-228	30-150	40-114	50-90	60-75	80-57	100-45	150-30	300-15	400-11.4	600-7.8
Weight	main unit only	kg	Less than 28.7kg														
Dimensions	(WxHxD)	mm	423 x 130.8 x 447.2														
Cooling			Forced air cooling by internal fan.														
Withstand voltage			AC to Chassis : 1500Vac/1min; AC to Output terminal : 3000Vac/1min; Vout ≤ 150V; Output terminal to Chassis:1000Vdc/1min; 150<Vout ≤ 600; Output terminal to Chassis:1500Vdc/1min														
Insulation resistance			Chassis and output terminal; chassis and AC input; AC input and output terminal: 100MΩ or more (DC 1000V)														

Notes:

- (*) Minimum voltage is guaranteed to maximum 0.2% of the rated output voltage.
- (*) Minimum current is guaranteed to maximum 0.4% of the rated output current.
- (*) Single phase 200V models: 170-265Vac. Three phase 200V models: 180-253Vac. Three phase 400V models: 360-440Vac.
- (*) From No-load to Full-load, constant input voltage. Measured at the sensing point in Remote Sense.
- (*) Measured at rated output voltage and current with JEITA RC-9131B probe
- (*) Measurement frequency bandwidth is 10Hz ~ 20MHz.
- (*) Measurement frequency bandwidth is 5Hz ~ 1MHz.
- (*) From 10% ~ 90% of rated output voltage, with rated resistive load.
- (*) From 90% ~ 100% of rated output voltage, with rated resistive load.
- (*) Time for output voltage to recover within 2% of its rated output for a load change from 50 ~ 100% of its rated output current. Voltage set point from 10% ~ 100% of rated output.
- (*) For load voltage change, equal to the unit voltage rating, constant input voltage.
- (*) For 6V ~ 20V model the ripple is measured at 2V ~ rated output voltage and full output current. For other models, the ripple is measured at 10 ~ 100% output voltage and full output current.
- (*) Single phase and three phase 200V models : at 200Vac input voltage. Three phase 400V models : at 400Vac input voltage. At rated output power.
- (*) If install the front panel filter kit, the temperature is guaranteed to 40 °C.

Programmable Switching D.C. Power Supply

SPECIFICATIONS

Model		PSU	6-800	8-720	12.5-480	15-400	20-304	30-200	40-152	50-120	60-100	80-76	100-60	150-40	300-20	400-15.2	600-10.4
Rated output voltage ^{(*)1}		V	6	8	12.5	15	20	30	40	50	60	80	100	150	300	400	600
Rated output current ^{(*)2}		A	800	720	480	400	304	200	152	120	100	76	60	40	20	15.2	10.4
Rated output power		W	4800	5760	6000	6000	6080	6000	6080	6000	6000	6080	6000	6000	6000	6080	6240
Constant Voltage Mode		PSU	6-800	8-720	12.5-480	15-400	20-304	30-200	40-152	50-120	60-100	80-76	100-60	150-40	300-20	400-15.2	600-10.4
Line regulation ^{(*)3}		mV	0.01% of rated output voltage +2mV														
Load regulation ^{(*)4}		mV	0.01% of rated output voltage +5mV														
Ripple and noise ^{(*)5}	p-p ^{(*)6}	mV	75	75	75	75	75	75	75	75	75	100	100	120	300	300	500
	r.m.s. ^{(*)7}	mV	10	10	10	10	10	10	10	10	10	15	15	25	35	35	120
Temperature coefficient		ppm/°C	100ppm/°C after a 30 minute warm-up														
Temperature stability			0.05% of rated output voltage over 8hrs interval following 30 minutes warm-up. Constant line, load & temp.														
Warm-up drift			Less than 0.05% of rated output voltage +2mV over 30 minutes following power on.														
Remote sense compensation voltage (single wire)		V	1	1	1	1	1	1.5	2	2	3	4	5	5	5	5	5
Rise time ^{(*)8}	No load	ms	80	80	80	80	80	80	80	80	80	150	150	150	150	200	250
Fall time ^{(*)9}	Rated load	ms	10	50	50	50	50	80	80	80	150	150	150	150	200	250	
	No load	ms	500	600	700	700	800	900	1000	1100	1100	1200	1500	2000	2500	3000	4000
Transient response time ^{(*)10}		ms	3	3	3	3	3	3	3	3	3	3	3	3	3	3	3
Constant Current Mode		PSU	6-800	8-720	12.5-480	15-400	20-304	30-200	40-152	50-120	60-100	80-76	100-60	150-40	300-20	400-15.2	600-10.4
Line regulation ^{(*)3}		mA	0.1% of rated output current														
Load regulation ^{(*)11}		mA	0.5% of rated output current														
Load regulation thermal drift			Less than 0.1% of rated output current over 30 minutes following load change.														
Ripple and noise ^{(*)12}	r.m.s.	mA	2000	1900	1500	1390	1250	650	365	245	170	140	116	104	30	20	15
Temperature coefficient		ppm/°C	100ppm/°C after a 30 minute warm-up														
Temperature stability			0.05% of rated output current over 8hrs interval following 30 minutes warm-up. Constant line, load & temp.														
Warm-up drift			6-15V model : Less than 0.5% rated output current over 30 minutes following power on. 20-600V model : Less than 0.25% rated output current over 30 minutes following power on.														
Protection Function		PSU	6-800	8-720	12.5-480	15-400	20-304	30-200	40-152	50-120	60-100	80-76	100-60	150-40	300-20	400-15.2	600-10.4
Over voltage protection (OVP)	Setting range	V	0.6 - 6.6	0.8 - 8.8	1.25 - 13.75	1.5 - 16.5	2 - 22	3 - 33	4 - 44	5 - 55	5 - 66	5 - 88	5 - 110	5 - 165	5 - 330	5 - 440	5 - 660
	Setting accuracy	mV	60	80	125	150	200	300	400	500	600	800	1000	1500	3000	4000	6000
Over current protection (OCP)	Setting range	A	5 - 880	5 - 792	5 - 528	5 - 440	5 - 334.4	5 - 220	5 - 167.2	5 - 132	5 - 110	5 - 83.6	5 - 66	4 - 44	2 - 22	1.52 - 16.72	1.04 - 11.44
	Setting accuracy	A	16	14.4	9.6	8	6.08	4	3.04	2.4	2	1.52	1.2	0.8	0.4	0.304	0.208
Under voltage limit (UVL)	Setting range		0 - 6.3	0 - 8.4	0 - 13.12	0 - 15.75	0 - 21	0 - 31.5	0 - 42	0 - 52.5	0 - 63	0 - 84	0 - 105	0 - 157.5	0 - 315	0 - 420	0 - 630
Over temperature protection (OHP)	Operation		Turn the output off.														
Incorrect sensing connection protection (SENSE)	Operation		Turn the output off.														
Low AC input protection (AC-FAIL)	Operation		Turn the output off.														
Shutdown (SD)	Operation		Turn the output off.														
Power limit (POWER LIMIT)	Operation		Over power limit.														
	Value (fixed)		Approx. 105% of rated output power														
Front Panel		PSU	6-800	8-720	12.5-480	15-400	20-304	30-200	40-152	50-120	60-100	80-76	100-60	150-40	300-20	400-15.2	600-10.4
Display, 4 digits	Voltage accuracy	mV	12	16	25	30	40	60	80	100	120	160	200	300	600	800	1200
	Current accuracy	mA	2400	2160	1440	1200	912	600	456	360	300	228	180	120	60	45.6	31.2
Indications			GREEN LED's: CV, CC, V, A, VSR, ISR, DLY, RMT, LAN, M1, M2, M3, RUN, Output ON; RED LED's: ALM, ERR														
Buttons			Lock/Local(Unlock), PROT(ALM_CLR), Function(M1), Test(M2), Set(M3), Shift, Output														
Knobs			Voltage, Current														
USB port			Type A USB connector														
Programming and Measurement (RS-232/485, USB, LAN, GPIB)		PSU	6-800	8-720	12.5-480	15-400	20-304	30-200	40-152	50-120	60-100	80-76	100-60	150-40	300-20	400-15.2	600-10.4
Output voltage programming accuracy	0.05% +	mV	3	4	6.25	7.5	10	15	20	25	30	40	50	75	150	200	300
Output current programming accuracy	0.2% +	mA	800	720	480	400	304	200	152	120	100	76	60	40	20	15.2	10.4
Output voltage programming resolution		mV	0.2	0.27	0.4	0.5	0.7	1	1.3	1.7	2	2.7	3.4	5.2	10.2	13.6	20.4
Output current programming resolution		mA	24	24	16	13.2	10	6.8	4.8	4	3.2	2.6	2	1.36	0.76	0.52	0.36
Output voltage measurement accuracy	0.1% +	mV	6	8	12.5	15	20	30	40	50	60	80	100	150	300	400	600
Output current measurement accuracy	0.2% +	mA	1600	1440	960	800	608	400	304	240	200	152	120	80	40	30.4	20.8
Output voltage measurement resolution		mV	0.2	0.27	0.4	0.5	0.7	1	1.3	1.7	2	2.7	3.4	5.2	10.2	13.6	20.4
Output current measurement resolution		mA	24	24	16	13.2	10	6.8	4.8	4	3.2	2.6	2	1.36	0.76	0.52	0.36
Input Characteristics		PSU	6-800	8-720	12.5-480	15-400	20-304	30-200	40-152	50-120	60-100	80-76	100-60	150-40	300-20	400-15.2	600-10.4
Normal input rating			B type : 1P2W 200V models, C type : 3P3W 200V models, D type : 3P4W 400V models														
Input voltage range			B type : 1P2W 170 - 265Vac, C type : 3P3W 180 - 253Vac, D type : 3P4W 360 - 440Vac														
Input frequency range			47Hz - 63Hz														
Maximum input current	200Vac / 400Vac	A	B type : 44A, C type : 29A, D type 22A														
Inrush current			B type : 1P2W 200V models Less than 200A; C type : 3P3W 200V model Less than 100A; D type : 3P4W 400V model Less than 100A.														
Power factor	200Vac / 400Vac		0.98 @ 1 Phase 200Vac / 0.95 @ 3 Phase 200/400Vac														
Efficiency ^{(*)13}		%	78.5	81	85	85	86	86	87	87	87	87	87	87	87	87	87
Hold-up time			20ms or greater														
Interface Capabilities		PSU	6-800	8-720	12.5-480	15-400	20-304	30-200	40-152	50-120	60-100	80-76	100-60	150-40	300-20	400-15.2	600-10.4
USB			TypeA: Host, TypeB: Slave, Speed: 1.1/2.0, USB Class: CDC(Communications Device Class)														
LAN			MAC Address, DNS IP Address, User Password, Gateway IP Address, Instrument IP Address, Subnet Mask														
RS-232 / RS-485			Complies with the EIA232D / EIA485 Specifications														
GPIB (Factory Option)			SCPI - 1993, IEEE 488.2 compliant interface														
Environmental Conditions		PSU	6-800	8-720	12.5-480	15-400	20-304	30-200	40-152	50-120	60-100	80-76	100-60	150-40	300-20	400-15.2	600-10.4
Operating temperature			0 °C - 50 °C ^{(*)14}														
Storage temperature			-25 °C - 70 °C														
Operating humidity			20% - 85% RH; No condensation														
Storage humidity			90% RH or less; No condensation														
Altitude			Maximum 2000m														
General Specifications		PSU	6-800	8-720	12.5-480	15-400	20-304	30-200	40-152	50-120	60-100	80-76	100-60	150-40	300-20	400-15.2	600-10.4
Weight	main unit only	kg	Less than 37.4kg														
Dimensions	(WxHxD)	mm	423 x 174.4 x 447.2														
Cooling			Forced air cooling by internal fan.														
Withstand voltage			AC to Chassis : 1500Vac/1min; AC to Output terminal : 3000Vac/1min; Vout ≤ 150V; Output terminal to Chassis:1000Vdc/1min; 150<Vout ≤ 600; Output terminal to Chassis:1500Vdc/1min														
Insulation resistance			Chassis and output terminal; chassis and AC input; AC input and output terminal: 100MΩ or more (DC 1000V)														

Notes:

- (*)1 Minimum voltage is guaranteed to maximum 0.2% of the rated output voltage.
- (*)2 Minimum current is guaranteed to maximum 0.4% of the rated output current.
- (*)3 Single phase 200V models: 170 - 265Vac. Three phase 200V models: 180 - 253Vac. Three phase 400V models: 360 - 440Vac.
- (*)4 From No-load to Full-load, constant input voltage. Measured at the sensing point in Remote Sense.
- (*)5 Measured at rated output voltage and current with JEITA RC-9131B probe
- (*)6 Measurement frequency bandwidth is 10Hz - 20MHz.
- (*)7 Measurement frequency bandwidth is 5Hz - 1MHz.
- (*)8 From 10% - 90% of rated output voltage, with rated resistive load.
- (*)9 From 90% - 10% of rated output voltage, with rated resistive load.
- (*)10 Time for output voltage to recover within 2% of its rated output for a load change from 50 - 100% of its rated output current. Voltage set point from 10% - 100% of rated output.
- (*)11 For load voltage change, equal to the unit voltage rating, constant input voltage.
- (*)12 For 6V - 20V model the ripple is measured at 2V - rated output voltage and full output current. For other models, the ripple is measured at 10 - 100% output voltage and full output current.
- (*)13 Single phase and three phase 200V models : at 200Vac input voltage. Three phase 400V models : at 400Vac input voltage. At rated output power.
- (*)14 If install the front panel filter kit, the temperature is guaranteed to 40 °C.

1U Handle & Bracket



**PSU-3kW****PSU-4.5kW****PSU-6kW****ORDERING INFORMATION**

PSU 6-200	1200W	Programmable Switching	DC Power Supply	PSU 60-25	1500W	Programmable Switching	DC Power Supply
PSU 8-180	1440W	Programmable Switching	DC Power Supply	PSU 80-19	1520W	Programmable Switching	DC Power Supply
PSU 12.5-120	1500W	Programmable Switching	DC Power Supply	PSU 100-15	1500W	Programmable Switching	DC Power Supply
PSU 15-100	1500W	Programmable Switching	DC Power Supply	PSU 150-10	1500W	Programmable Switching	DC Power Supply
PSU 20-76	1520W	Programmable Switching	DC Power Supply	PSU 300-5	1500W	Programmable Switching	DC Power Supply
PSU 30-50	1500W	Programmable Switching	DC Power Supply	PSU 400-3.8	1520W	Programmable Switching	DC Power Supply
PSU 40-38	1520W	Programmable Switching	DC Power Supply	PSU 600-2.6	1560W	Programmable Switching	DC Power Supply
PSU 50-30	1500W	Programmable Switching	DC Power Supply				

ACCESSORIES :

CD-ROM x 1 (User Manual, Programming Manual), Output terminal cover x 1, Analog connector plug kit x 1, Output terminal M8 bolt set(6V-60V model), Input terminal cover x 1, 1U Handle(RoHS), 1U Bracket(LEFT, RoHS), 1U Bracket (RIGHT,RoHS), Power Cord(10A) provided for certain regions only

OPTIONAL ACCESSORIES

PSU-01B	Bus Bar for 2 units in parallel operation (Applies to models ≤60 volts)	GTL-246	USB Cable, USB 2.0A-B Type Cable, 4P
PSU-01C	Cable for 2 units in parallel connection	GTL-258	GPB Cable, 2000mm
PSU-02B	Bus Bar for 3 units in parallel operation (Applies to models ≤60 volts)	GTL-259	RS-232 Cable with DB9 connector to RJ45
PSU-02C	Cable for 3 units in parallel connection	GTL-260	RS-485 Cable with DB9 connector to RJ45
PSU-03B	Bus Bar for 4 units in parallel operation (Applies to models ≤60 volts)	GTL-261	Serial Master Cable+Terminator, 0.5M
PSU-03C	Cable for 4 units in parallel connection	GTL-262	RS-485 Slave cable
PSU-232	RS232 Cable with DB9 connector kit	GRM-001	Slide bracket 2pcs/set ,PSU option
PSU-485	RS485 Cable with DB9 connector kit	PSU-GPIB	GPIB Interface card (factory option)
PSU-001	Front panel filter kit(factory installed)	GPW-001	UI_ICSA power cord 3m ,PSU option
PSU-01A	Joins a vertical stack of 2 PSU units together. 2U-sized handles x2, joining plates x2	GPW-002	VDE power cord 3m ,PSU option
PSU-02A	Joins a vertical stack of 3 PSU units together. 3U-sized handles x2, joining plates x2	GPW-003	PSE power cord 3m ,PSU option
PSU-03A	Joins a vertical stack of 4 PSU units together. 4U-sized handles x2, joining plates x2		
PSU-ISO-1	Isolate current remote control card(factory option)		
PSU-ISO-V	Isolate voltage remote control card(factory option)		

FREE DOWNLOAD

Driver LabView Driver

PSU-001**PSU-01C****PSU-02C****GPW-001****PSU-01A****PSU-01B****PSU-232****PSU-03B****GPW-002****PSU-02A****PSU-02B****PSU-485****PSU-03C****GPW-003****PSU-03A****GRM-001****GTL-259****GTL-260****GTL-261****GTL-262**

Programmable Switching D.C. Power Supply

A. SERIES/PARALLEL OPERATION AND HIGH POWER DENSITY

Series Connection	1 unit	2 units	Series Parallel	1 unit	2 units	3 units	4 units
Height of sets	1U	2U	Height of sets	1U	2U	3U	4U
PSU 6-200	6V 200A	12V 200A	PSU 6-200	6V 200A	6V 400A	6V 600A	6V 800A
PSU 8-180	8V 180A	16V 180A	PSU 8-180	8V 180A	8V 360A	8V 540A	8V 720A
PSU 12.5-120	12.5V 120A	25V 120A	PSU 12.5-120	12.5V 120A	12.5V 240A	12.5V 360A	12.5V 480A
PSU 15-100	15V 100A	30V 100A	PSU 15-100	15V 100A	15V 200A	15V 300A	15V 400A
PSU 20-76	20V 76A	40V 76A	PSU 20-76	20V 76A	20V 152A	20V 228A	20V 304A
PSU 30-50	30V 50A	60V 50A	PSU 30-50	30V 50A	30V 100A	30V 150A	30V 200A
PSU 40-38	40V 38A	80V 38A	PSU 40-38	40V 38A	40V 76A	40V 114A	40V 152A
PSU 50-30	50V 30A	100V 30A	PSU 50-30	50V 30A	50V 60A	50V 90A	50V 120A
PSU 60-25	60V 25A	120V 25A	PSU 60-25	60V 25A	60V 50A	60V 75A	60V 100A
PSU 80-19	80V 19A	160V 19A	PSU 80-19	80V 19A	80V 38A	80V 57A	80V 76A
PSU 100-15	100V 15A	200V 15A	PSU 100-15	100V 15A	100V 30A	100V 45A	100V 60A
PSU 150-10	150V 10A	300V 10A	PSU 150-10	150V 10A	150V 20A	150V 30A	150V 40A
PSU 300-5	300V 5A	600V 5A	PSU 300-5	300V 5A	300V 10A	300V 15A	300V 20A
PSU 400-3.8	400V 3.8A	NA	PSU 400-3.8	400V 3.8A	400V 7.6A	400V 11.4A	400V 15.2A
PSU 600-2.6	600V 2.6A	NA	PSU 600-2.6	600V 2.6A	600V 5.2A	600V 7.8A	600V 10.4A

To augment output power, the PSU-series can realize two-fold rated power (models under 300V) via 2 same model units in series connection; and four-fold rated power via 4 same model units in parallel connection so as to satisfy customers with large voltage and large current requirements. 2U height units in series connection can achieve maximum 600V output. 4U height units in parallel connection can output maximum 800A and 6240W.

B. REMOTE PROGRAM CONTROL (UP TO 31 UNITS CONNECTION)

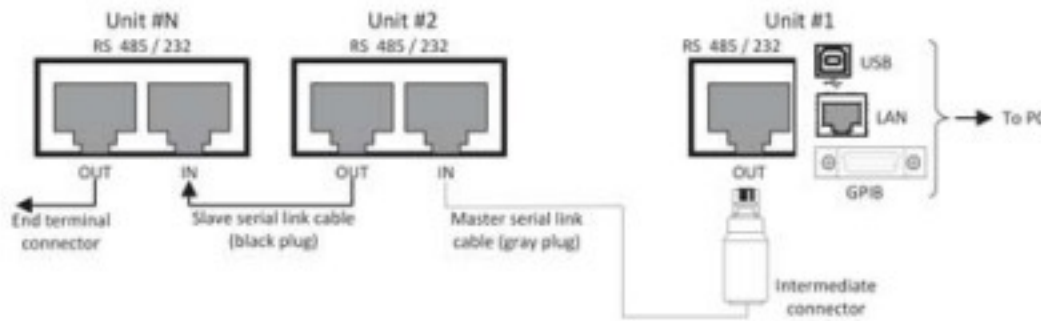

Provide RS-232, RS-485, USB, GPIB and LAN for PC to remote control Master PSU-Series. RJ-45 connector on the rear panel can connect up to 31 units. LAN or USB remote control and augmenting slave units by using PSU-Series multi-drop mode will no longer need any switch/hub that can help customers save equipment costs.

* For the detailed information please refer to User Manual

C. BLEEDER CONTROL

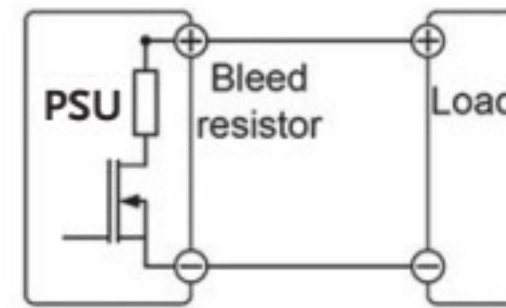

PSU-Series Built-in Bleed Resistor

The PSU-Series employs a bleed resistor in parallel with the output terminal. Bleed resistor is designed to dispatch the power from the power supply filter capacitors when power is turned off or the load is disconnected. Without a bleed resistor, power terminal may remain charged on the filter capacitors for some time and be potentially hazardous. In addition, bleed resistor also allows for smoother voltage regulation of the power supply as the bleed resistor acts as a minimum voltage load. The bleed resistance can be turned on or off using the configuration setting.

D. C.V/C.C PRIORITY MODE

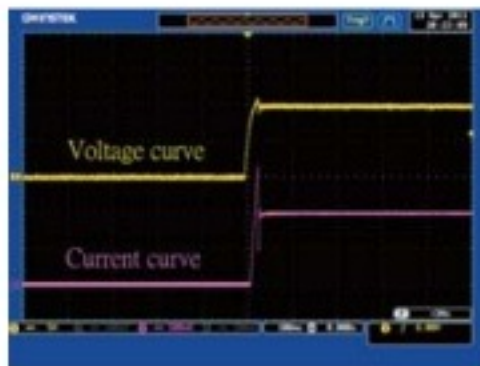

Under the conventional C.V mode, inrush current and surge voltage appeared at forward voltage (V_f) of LED.

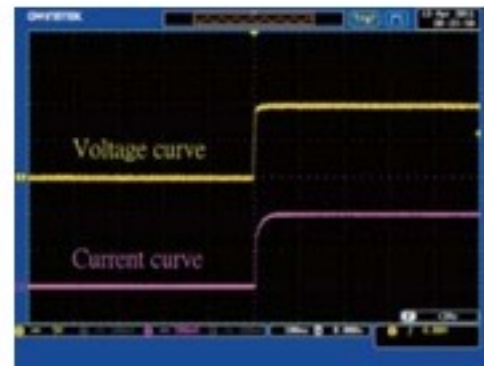

Under C.C priority mode, inrush and surge voltage are effectively restrained.

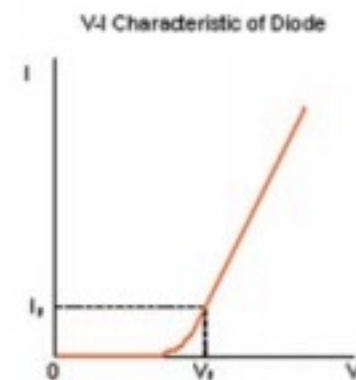

V-I Characteristic of Diode

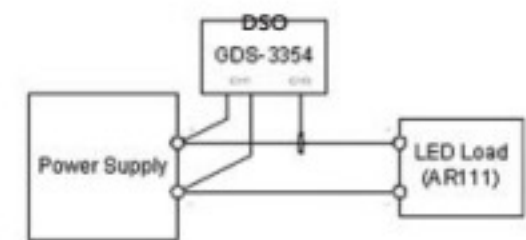

Using GDS-3354 DSO to Test LED Operation Under C.V Priority and C.C Priority Respectively

Conventional power supplies under the CV priority mode will produce inrush current and surge voltage at turn-on. The PSU-series has CV and CC priority modes.

The CC priority mode can prevent inrush current and surge voltage from occurring at turn-on to protect DUT.

E. ADJUSTABLE SLEW RATE

VOLTAGE SLEW RATE	CURRENT SLEW RATE
0.001V~0.060V/msec (PSU 6-200)	0.001A~2.000A / msec (PSU 6-200)
0.001V~0.080V/msec(PSU 8-180)	0.001A~1.800A / msec (PSU 8-180)
0.001V~0.125V/msec (PSU 12.5-120)	0.001A~1.200A / msec (PSU 12.5-120)
0.001V~0.150V/msec(PSU 15-100)	0.001A~1.000A / msec(PSU 15-100)
0.001V~0.200V/msec (PSU 20-76)	0.001A~0.760A / msec (PSU 20-76)
0.001V~0.300V/msec(PSU 30-50)	0.001A~0.500A / msec(PSU 30-50)
0.001V~0.400V/msec (PSU 40-38)	0.001A~0.380A / msec (PSU 40-38)
0.001V~0.500V/msec(PSU 50-30)	0.001A~0.300A / msec(PSU 50-30)
0.001V~0.600V/msec (PSU 60-25)	0.001A~0.250A / msec (PSU 60-25)
0.001V~0.800V/msec(PSU 80-19)	0.001A~0.190A / msec(PSU 80-19)
0.001V~1.000V/msec (PSU 100-15)	0.001A~0.150A / msec (PSU 100-15)
0.001V~1.500V/msec (PSU 150-10)	0.001A~0.100A / msec (PSU 150-10)
0.001V~1.500V/msec (PSU 300-5)	0.001A~0.025A / msec (PSU 300-5)
0.001V~2.000V/msec (PSU 400-3.8)	0.001A~0.008A / msec (PSU 400-3.8)
0.001V~2.400V/msec (PSU 600-2.6)	0.001A~0.006A / msec (PSU 600-2.6)

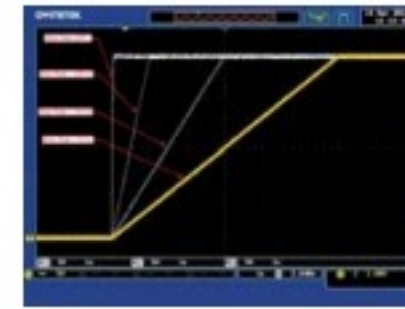

Adjustable Voltage Slew Rate

The PSU series can adjust slew rate for current and voltage. Via setting the rise and fall time of voltage and current, users can verify DUT's characteristics during voltage and current variation. Additionally, slew rate adjustment can mitigate voltage shift to effectively prevent DUT from being damaged by inrush current. This function is ideal for tests such as capacitive load and motor.

F. OVP, OCP AND UVL

MODEL	OCP	OVP	UVL
PSU 6-200	5 ~ 220A	0.6 ~ 6.6V	0 ~ 6.3V
PSU 8-180	5 ~ 198A	0.8 ~ 8.8V	0 ~ 8.4V
PSU 12.5-120	5 ~ 132A	1.25 ~ 13.75V	0 ~ 13.12V
PSU 15-100	5 ~ 110A	1.5 ~ 16.5V	0 ~ 15.75V
PSU 20-76	5 ~ 83.6A	2 ~ 22V	0 ~ 21V
PSU 30-50	5 ~ 55A	3 ~ 33V	0 ~ 31.5V
PSU 40-38	3.8 ~ 41.8A	4 ~ 44V	0 ~ 42V
PSU 50-30	3 ~ 33A	5 ~ 55V	0 ~ 52.5V
PSU 60-25	2.5 ~ 27.5A	5 ~ 66V	0 ~ 63V
PSU 80-19	1.9 ~ 20.9A	5 ~ 88V	0 ~ 84V
PSU 100-15	1.5 ~ 16.5A	5 ~ 110V	0 ~ 105V
PSU 150-10	1 ~ 11A	5 ~ 165V	0 ~ 157.5V
PSU 300-5	0.5 ~ 5.5A	5 ~ 330V	0 ~ 315V
PSU 400-3.8	0.38 ~ 4.18A	5 ~ 440V	0 ~ 420V
PSU 600-2.6	0.26 ~ 2.86A	5 ~ 660V	0 ~ 630V

Once the voltage or current output exceeds the preset level of OVP or OCP, PSU will shut down output to protect DUT. UVL is for users to set the minimum output voltage from the output terminal.

G. TRIGGER CONTROL (TRIGGER INPUT/TRIGGER OUTPUT)

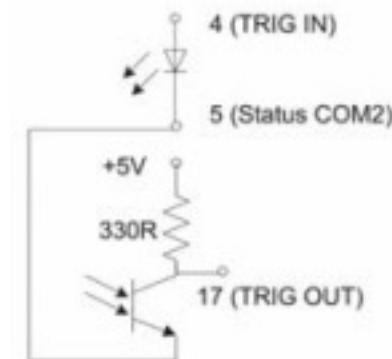

PSU-series provides users with complete trigger input and trigger output functions so as to flexibly control PSU-series. Each function is elaborated as follows.

Trigger Input function :

1. Allow users to set the effective pulse width from 0~60ms for trigger input (0: the LOW or HIGH signal of DC level for trigger input)
2. Receive trigger input to control PSU-series output or to output preset voltage and current.
3. Receive trigger input to upload preset memory parameters.

Trigger Output function :

1. Allow users to set the effective pulse width from 0~60ms for trigger output (0: the LOW or HIGH signal of DC level for trigger output)
2. Set LOW or HIGH for output DC level
3. PSU produces trigger output signal when setting output or changing preset value or uploading preset memory parameters.

H. EXTERNAL ANALOG CONTROL FUNCTION

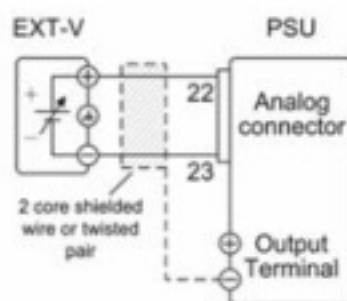

- Pin23 → EXT-V (-)
- Pin22 → EXT-V (+)
- Wire shield → negative (-) output terminal

External Voltage Controls Voltage Range

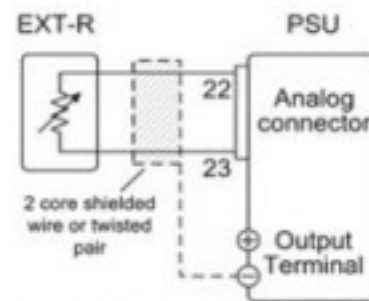

- Pin22 → EXT-R
- Pin23 → EXT-R
- Wire shield → negative (-) output terminal

External Resistance Controls Voltage Range

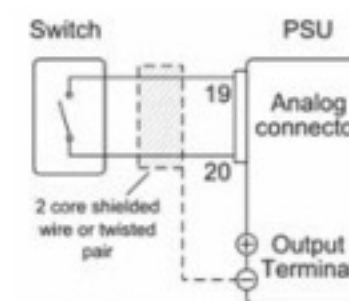

- Pin19 → Switch
- Pin20 → Switch
- Wire shield → negative (-) output terminal

External On-off to Control Output, on or off

The rear panel of the PSU-series has an analog control terminal. The external analog control interface allows external voltage or resistance to control voltage and current output; and allows power supply to output or to be turned on and off. The diagram on the upper shows typical connection methods for external control applications. For more detailed connection information please refers to user manual.

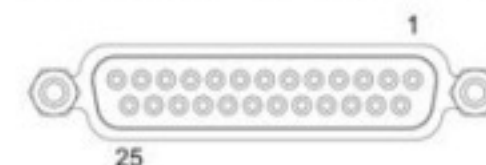

Fanless Multi-Range D.C. Power Supply



PFR-100L



PFR-100M



FEATURES

- * Constant Power Output for Fivefold Multi-Range(V&I) Operation
- * Natural Convection Cooling Design (Fanless Structure)
- * Preset Memory Function
- * Output ON/OFF Delay Function
- * CV, CC Priority Mode
- * Adjustable Slew Rate For Voltage and Current
- * Bleeder Circuit Control
- * Protection : OVP, OCP, AC FAIL and OTP
- * Support Front Panel and Rear Panel Output
- * Interface: USB,LAN,RS-232/485(std.); GPIB(opt.)
- * Web Server Monitoring and Control
- * External Analog Control and Monitor Function
- * Remote Sensing Function

Model	PFR-100L	PFR-100M
Output Channel	1	1
Output Voltage	0~ 50V	0~ 250V
Output Current	0~ 10A	0~ 2A
Rated Power	100W	100W

The PFR-100 series, a small and high-performance programmable D.C. power supply, adopts natural convection design to dissipate heat. The fanless structure allows users to focus on their experiments and tests in a quiet environment. Fanless power supply will not suck in dust and foreign objects, therefore, PFR-100 series has a longer life cycle compared with that of power supplies with fan.

The PFR-100 series is a power supply with a five-fold rated power that allows users to self-define voltage and current under rated power conditions so as to satisfy them with wider voltage and current operational ranges. PFR-100 series, with rated 100W, provides two models: PFR-100L- maximum output voltage of 50V (at 2A) or maximum output current of 10A (at 10V); PFR-100M- maximum output voltage of 250V (at 0.4A) or maximum output current of 2A (at 50V).

The PFR-100 series provides front and rear panel output terminals. The front panel output terminal helps users shorten test lead replacement time while conducting adjustment on front panel's function keys. The rear panel output terminal facilitates an easy wiring operation for rackmount assembly. 3U height, 70mm width and 2.5KG in weight have greatly elevated PFR-100 series portability. Furthermore, the multi-drop mode allows users to control up to 31 PFR-100 series without using switch/Hub that help users save the equipment cost.

The LAN interface for PFR-100 is Ethernet port. PFR-100 also has a built-in web server and intuitive user interface. Users, via general browsers including Internet Explorer, Mozilla Firefox or Android cellular phones, can monitor PFR-100's test and measurement anywhere. Users not only can remotely monitor PFR-100 via internet, but also remotely observe and adjust their operating PFR-100s in the lab from your home. The outputs of PFR-100 series can be monitored including OVP, OCP, UVL; and the system information can be checked such as unit's serial number, firmware edition and internet setting. Users can remotely adjust PFR-100 settings, including output voltage/current, the slew rate for voltage/current, Bleeder circuit control, OCP, delayed time for output voltage and Buzzer settings.

The PFR-100 series provides special functionalities to meet test requirements for different load's characteristics. The CC priority mode can be applied for DUTs with diode characteristics to prevent DUT from being damaged by inrush current. A slow rise time for voltage can also protect DUT from inrush current, especially for tests on capacitive load. When power is off or load is disconnected, the activation of Bleeder circuit control will allow the bleeder resistor to consume filter capacitor's electricity. Without the bleed resistor, power supply's filter capacitor may still have electricity that is a potential hazard. For automatic testing equipment systems, the bleeder resistor allows PFR-100 series to rapidly discharge to prepare itself for the next operation.

SPECIFICATIONS			
Model		PFR-100L	PFR-100M
OUTPUT RATING			
Rated Output Voltage		50V	250V
Rated Output Current		10A	2A
Rated Output Power		100W	100W
REGULATION(CV)			
Load Regulation (*2)		10mV	33mV
Line Regulation (*1)		3mV	5mV
REGULATION(CC)			
Load Regulation (*9)		10mA	3.2mA
Line Regulation (*1)		8mA	1.2mA
RIPPLE & NOISE (*3)			
Vp-p (*4)		50mV	150mV
Vr.m.s.(*5)		4mV	15mV
A r.m.s.		10mA	2mA
PROGRAMMING ACCURACY			
Voltage	0.1% of setting +	40mV	200mV
Current	0.2% of setting +	20mA	2mA
MEASUREMENT ACCURACY			
Voltage	0.1% of reading +	40mV	200mV
Current	0.2% of reading +	20mA	2mA
RESPONSE TIME			
Rise Time (*6)	Rated load	50ms	100ms
Fall Time (*7)	Rated load	100ms	200ms
	No load	500ms	1000ms
Transient Response Time (*8)		1.5ms	2ms
PROGRAMMING RESOLUTION			
Voltage		2mV	10mV
Current		1mA	0.1mA
MEASUREMENT RESOLUTION			
Voltage		2mV	10mV
Current		1mA	0.1mA
PROTECTION FUNCTION			
Over Voltage Protection (OVP)	Setting range	5~55V	5~275V
Over Current Protection (OCP)	Setting range	1~11A	0.2~2.2A
Under Voltage Limit (UVL)	Setting range	0~52.5V	0~262.5V
Over Temperature Protection (OTP)	Operation	Turn the output off.	Turn the output off.
Low AC Input Protection (AC-Fail)	Operation	Turn the output off.	Turn the output off.
Power Limit (Power Limit)	Operation	Turn the output off.	Turn the output off.



PFR-Series

SPECIFICATIONS

Model	PFR-100L	PFR-100M
FRONT PANEL DISPLAY ACCURACY, 4 DIGITS		
Voltage	0.1% of reading + 40mV	200mV
Current	0.2% of reading + 20mA	2mA
ENVIRONMENT CONDITION		
Operating Temperature	0°C to 40°C	
Storage Temperature	-20°C to 70°C	
Operating Humidity	20% to 80% RH; No condensation	
Storage Humidity	20% to 85% RH; No condensation	
READBACK TEMP. COEFFICIENT(After A 30 Minute Warm-up)		
Voltage	100ppm/°C	
Current	200ppm/°C	
OTHER		
Analog Control	Yes	
Interface	USB, LAN, RS-232/485(std.); GPIB(opt.)	
AC Input	85-265VAC, 47-63Hz, single phase	
DIMENSIONS & WEIGHT		
	70(W)x124(H)x300(D)mm; Approx. 2.5kg	

Note: *1: At 85 ~ 132Vac or 170 ~ 265Vac, constant load.
 *2: From No-load to Full-load, constant input voltage. Measured at the sensing point in Remote Sense.
 *3: Measure with JEITA RC-9131B (1:1) probe
 *4: Measurement frequency bandwidth is 10Hz to 20MHz.
 *5: Measurement frequency bandwidth is 5Hz to 1MHz.
 *6: From 10%~90% of rated output voltage, with rated resistive load.
 *7: From 90%~10% of rated output voltage, with rated resistive load.
 *8: Time for output voltage to recover within 0.1% + 10mV of its rated output for a load change from 50 to 100% of its rated output current.
 *9: For load voltage change, equal to the unit voltage rating, constant input voltage.

ORDERING INFORMATION

PFR-100L Fanless Multi-Range D.C. Power Supply
PFR-100M Fanless Multi-Range D.C. Power Supply (European terminals provided only)

ACCESSORIES :
 CD(User Manual, Programming manual) x 1, Power cord, GTL-134 test lead, Accessory Packages
 GTL-104A test lead (for PFR-100L only), GTL-105A test lead (for PFR-100M only),
 GTL-204A test lead (for PFR-100L European Type Jack Terminal)

OPTIONAL ACCESSORIES

GTL-258 GPIB Cable, 2000mm	GTL-259 RS-232 Cable with DB9 connector to RJ45
PSU-232 RS-232 Cable with DB9 Connector Kit	GTL-260 RS-485 Cable with DB9 connector to RJ45
PSU-485 RS-485 Cable with DB9 Connector Kit	GTL-261 Serial Master Cable+Terminator, 0.5M
GTL-246 USB Cable (USB 2.0 Type A-TypeB Cable)	GTL-262 RS-485 Slave cable
GRA-431-J-100/200 Rack mount Kit(JIS)with AC 100V/200V	
GRA-431-E-100/200 Rack mount Kit(EIA)with AC 100V/200V	
PFR-GPIB Optional GPIB Interface for PFR (Factory installed)	

GTL-259



GTL-260



GTL-261



GTL-262



Rear Panel



GRA-431-J/E Rack Mount Kit(JIS/EIA)



PSU-232 RS-232 Cable with DB9 Connector Kit



PSU-485 RS-485 Cable with DB9 Connector Kit



GTL-258 GPIB Cable, 2000mm



GTL-134 Test Lead



Programmable Switching D.C. Power Supply (Multi-range D.C. Power Supply)



PSB-2400L2



**PSB-2400L/PSB-2400H/
PSB-2800L/PSB-2800H**



PSB-2800LS



Note : PSB-2400H/PSB-2800H are not CE approved

FEATURES

- * Output Voltage Rating : 80V/800V, Output Power Rating : 400W ~ 800W
- * Constant Power Output for Multi-Range (V & I) Operation
- * Series and Parallel Operation (2 Units in Series or 4 Units in Parallel Maximum)
- * 90 Degree Angle Rotatable Control Panel
- * Sequence Function Edited by PC will be Controlled Through Power Supply Optional Interfaces
- * Standard Interface : RS-232C/USB/Analog Control Interface
- * Optional Interface : GPIB
- * Preset Function (3 Points)
- * LabVIEW Driver

The PSB-2000 Series is a high power density, programmable and multi-range output DC power supply. There are six models in the series including one power booster unit. The PSB-2000 Series has the output voltage of 0~80V and 0~800V, and the output power ranges of 0~400W and 0~800W. The multi-range output functionality facilitates flexible collocations of higher voltage and larger current under the rated power range. Both series and parallel connections can be applied to the PSB-2000 Series to fulfill the requirements of higher

The PSB-2000 Series provides three sets of preset function keys to memorize regularly used settings of voltage, current and power that users can recall rapidly. The sequence function, via RS232C, USB interface or optional GPIB interface, can connect with the computer to produce output power defined by sequence of a series of set voltage and current steps that are defined by the computer. This function is often used to establish a standard test procedure for the verification of the influence on DUTs done by the swiftly changing operating

The PSB-2000 Series protects over voltage and over current. The power supply output function will be shut down to protect DUTs while the protection mechanism is triggered to function. When conducting battery charging operation, the Hi-Ω mode of the PSB-2000 Series will prevent reverse current from damaging power supply.

The PSB-2000 Series provides analog control interfaces on the rear panel to control PSB-2000 Series output via the external voltage or to externally monitor voltage and current output status of power supply. The PSB-2000 Series panel can be rotated 90 degree angle suitable for vertical or horizontal position to accommodate the ideal space utilization.

SERIES OPERATION

MODEL NUMBER	SINGLE UNIT	TWO UNITS
PSB-2400L	80V/40A	160V/40A
PSB-2800L	80V/80A	160V/80A
PSB-2800LS (Booster Unit for PSB-2800L Only)	N/A	N/A
PSB-2400L2	N/A	N/A
PSB-2400H	N/A	N/A
PSB-2800H	N/A	N/A

PARALLEL OPERATION

MODEL NUMBER	SINGLE UNIT	TWO UNITS	THREE UNITS	FOUR UNITS
PSB-2400L	80V/40A	80V/80A	80V/120A	80V/160A
PSB-2800L	80V/80A	80V/160A	80V/240A	80V/320A
PSB-2800LS	N/A	80V/160A (PSB-2800L x 1+ PSB-2800LS x 1)	80V/240A (PSB-2800L x 1+ PSB-2800LS x 2)	N/A
PSB-2400L2	N/A	N/A	N/A	N/A
PSB-2400H	800V/3A	800V/6A	N/A	N/A
PSB-2800H	800V/6A	800V/12A	N/A	N/A

SPECIFICATIONS						
	PSB-2400L	PSB-2800L	PSB-2400L2	PSB-2400H	PSB-2800H	PSB-2800LS
OUTPUT RATING						
Voltage	0 – 80V	0 – 80V	0 – 80V x 2CH	0 – 800V	0 – 800V	80V
Current	0 – 40A	0 – 80A	0 – 40A x 2CH	0 – 3A	0 – 6A	80A
Power	400W	800W	800W	400W	800W	800W
REGULATION (CV)						
Load	0.01% ± 3mV of rated voltage			0.01% ± 30mV of rated voltage		N/A
Line	0.01% ± 2mV of rated voltage			0.01% ± 20mV of rated voltage		
REGULATION (CC)						
Load	0.02% ± 3mA of rated current			0.05% ± 15mA of rated current		N/A
Line	0.01% ± 2mA of rated current			0.05% ± 10mA of rated current		
RIPPLE & NOISE (Noise Bandwidth 20MHz ; Ripple Bandwidth=1MHz)						
CV p-p	90mV	150mV	90mV	250mV(only output voltage measures more than 1% of the rated voltage)	300mV(only output voltage measures more than 1% of the rated voltage)	N/A
CV rms	4mV	6mV	4mV	20mV(when current measures<2A) 35mV(when current measures>2A)	25mV(when current measures<2A) 40mV(when current measures>2A)	
CC rms	30mA	60mA	30mA	15mA	20mA	
PROGRAMMING ACCURACY						
Voltage	0.1% setting±2digits			0.1% setting±2digits		N/A
Current	0.2% setting±2digits			0.2% setting±2digits		
Power	± 10W			±10W (only output voltage measures more than 1% of rated voltage)		
READ BACK ACCURACY						
Voltage	0.2% reading±2digits			0.2% reading±2digits		N/A
Current	0.3% reading±2digits			0.3% reading±2digits		
Power	0.5% reading±5digits			0.5% reading±Vout x 40mA		
RESPONSE TIME						
Raise Time(Full load/No load)	50ms			200ms		N/A
Fall Time(Full load)	100ms			500ms		
Fall Time(No load)	500ms			1000ms		
Load Transient Recover Time (Load change from 50-100%)	1ms			7ms		
PROGRAMMING RESOLUTION						
Voltage	10mV			100mV		N/A
Current	10mA			10mA		
Power	10W			10W		
MEASUREMENT RESOLUTION						
Voltage	10mV			100mV		N/A
Current	10mA			10mA		
Power	10W			10W		
SERIES AND PARALLEL CAPABILITY						
Channel Number	1	1	2	1	1	
Series Operation	Up to 2 Units	Up to 2 Units	N/A	N/A	N/A	
Parallel Operation	Up to 4 Units	Up to 4 Units	N/A	Up to 2 Units	Up to 2 Units	For PSB-2800L Only
Parallel with booster PSB-2800LS	N/A	Up to 3 Units	N/A	N/A	N/A	
PROTECTION FUNCTION						
OVP (Fixed)	Output off when 110% of rated voltage			Output off when output voltage exceeds 110% of rated voltage		N/A
OVP (Variable)	Output off when operating; Setting range:1V-84V with front panel			Presetable in range from 10V – 840V om front panel		
OCP (Fixed)	Output off when 110% of rated current			Output off when output voltage exceed 110% of rated current		
OCP (Variable)	Output off when operating;Setting range:1A-42A(84A for model number)			Presetable in range from 0.1A – 6.30A om front panel		
OHP	Output off above heat sink setting temperature			Output off at the internal heat sink temperature over setting value		
ENVIRONMENT CONDITION						
Operation Temp	0°C – 40°C					N/A
Storage Temp	-20°C – 70°C					
Operating Humidity	30% – 80% RH (no dew condensation)					
Storage Humidity	30% – 80% RH (no dew condensation)					
OTHER						
Inrush Current	35A Max	70A Max	70A Mmax	35A Max	70A Max	70A Max
Power Consumption/Factor	560VA/0.99	1120VA/0.99	1120VA/0.99	560VA/0.99	1120VA/0.99	1120VA/0.99
Cooling Method	Forced air-cooling with fan motor					
Power Source	100VAC – 240VAC, 50/60Hz, Single phase					
Interface (Standard)	RS-232C/USB					
Interface (Optional)	GPIB					
Analog Control	Yes					
DIMENSIONS & WEIGHT						
	210(W) x 124(H) x 290(D)mm					
	Approx.5kg	Approx.7kg	Approx.7kg	Approx. 5kg	Approx. 6kg	Approx. 7kg

Programmable Switching D.C. Power Supply (Multi-range D.C. Power Supply)



PSB-2400L2



**PSB-2400L/PSB-2400H/
PSB-2800L/PSB-2800H**



PSB-2800LS

Rear Panel



PSB-003 Parallel Connection Kit for Horizontal Installation



PSB-004 Parallel Connection Kit for Vertical Installation



ORDERING INFORMATION

PSB-2400L	0-80V/0-40A/400W Multi-Range DC Power Supply
PSB-2800L	0-80V/0-80A/800W Multi-Range DC Power Supply
PSB-2400L2	0-80V x 2/0-40A x 2/800W Multi-Range DC Power Supply
PSB-2400H	0-800V/0-3A/400W Multi-Range DC Power Supply
PSB-2800H	0-800V/0-6A/800W Multi-Range DC Power Supply
PSB-2800LS	800W Slave (Booster) Unit For Current Extension Only

ACCESSORIES :

User Manual (CD) x 1, AC Power Cord x 1, External Control Connector (26pin), Screws for output terminals on rear panel, Protection covers for output terminals on rear panel, Protection caps for output terminals on the front panel, GND Cable, USB Cable (For Model Number : PSB-2400L; PSB-2800L; PSB-2400L2; PSB-2400H; PSB-2800H) Local Bus (For Model Number : PSB-2400L; PSB-2800L; PSB-2400L2; PSB-2400H; PSB-2800H)

OPTIONAL ACCESSORIES

PSB-001	GPIB Card	GTL-246	USB Cable
PSB-003	Parallel Connection Kit for Horizontal Installation. Kit Includes : (PSB-007 Joint Kit, Horizontal bus bar x 2 , PSB-005 x1)	GTL-248	GPIB Cable
PSB-004	Parallel Connection Kit for Vertical Installation. Kit Includes : (PSB-007 Joint Kit, Vertical bus bar x 2, PSB-005 x 1)	GRJ-1101	Modular Cable
PSB-005	Parallel Connection Signal Cable	GRA-424	Rack Mount Kit
PSB-006	Series Connection Signal Cable		
PSB-007	Joint Kit : Includes 4 Joining Plates, (M3x6)screws x 4 ; (M3x8)screw x 2		
PSB-008	RS232C Cable (PSB-2000 Only)		

FREE DOWNLOAD

Driver Labview Driver

PSB-001 GPIB Control Board



GRJ-1101 Modular Cable



PSB-008 RS-232C Cable (PSB-2000 Only)



PSB-005 Parallel Connection Signal Cable



PSB-006 Series Connection Signal Cable



PSB-007 Joint Kit



A. MULTI-RANGE OUTPUT OPERATION

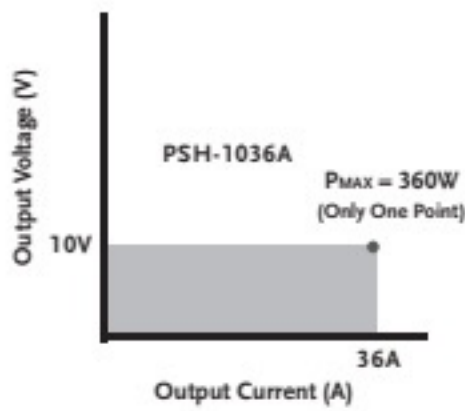

The operation area of a Conventional Power Supply

Compared with the maximum power output of the conventional power supply that is calculated by the maximum output voltage multiplies by the maximum output current, the PSB-2000 series, defying the formula, has a unique characteristic of multi-range output (voltage and current). This distinguishing feature, under the same maximum power output range, can output a higher voltage with a smaller current and vice versa. For instance, for a conventional power supply with a maximum power output of 360W, the maximum voltage and current outputs are likely to be

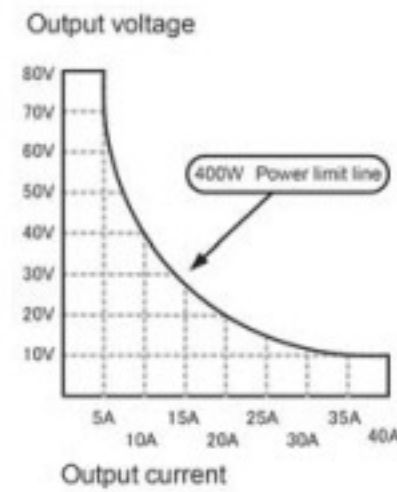

The operation area of a Multi-Range Power Supply for PSB-2000 Series

10V and 36A respectively. Comparatively, PSB-2400L, with the maximum power output of 400W, provides voltage and current output ranges of 0~80V and 0~40A. The maximum current of 5A will be provided when the voltage reaches 80V and the maximum voltage of 10V for the maximum current of 40A. PSB-2400L, breaking the limitation of $P_{max}=V_{max} \times I_{max}$, broadens voltage and current application ranges. The following diagrams illustrate the voltage and current comparison between the multi-range output power supply and the conventional power supply.

B. PRODUCTS IN THE SERIES

There are six models in the PSB-2000 Series. Model type, output voltage, output current and output power are as follows :

MODEL	PSB-2400L	PSB-2800L	PSB-2400L2	PSB-2400H	PSB-2800H	PSB-2800LS*
Channel Number	1	1	2	1	1	NA
Voltage Rating**	0 ~ 80V	0 ~ 80V	0 ~ 80V x 2CH	0 ~ 800V	0 ~ 800V	80V
Current Rating***	0 ~ 40A	0 ~ 80A	0 ~ 40A x 2CH	0 ~ 3A	0 ~ 6A	80A
Output Power (Max.)	400W	800W	800W	400W	800W	800W

- * PSB-2800LS, a booster unit acting as slave to extend current, can not operate alone. It must operate with PSB-2800L master.
- ** The maximum current under the highest output voltage is power/voltage. For instance, when PSB-2400L outputs 80V the maximum current is $400W/80V = 5A$.
- *** Same as above. When PSB2400L outputs 40A the highest voltage is $400W/40A = 10V$.

C. SERIES AND PARALLEL CONNECTIONS

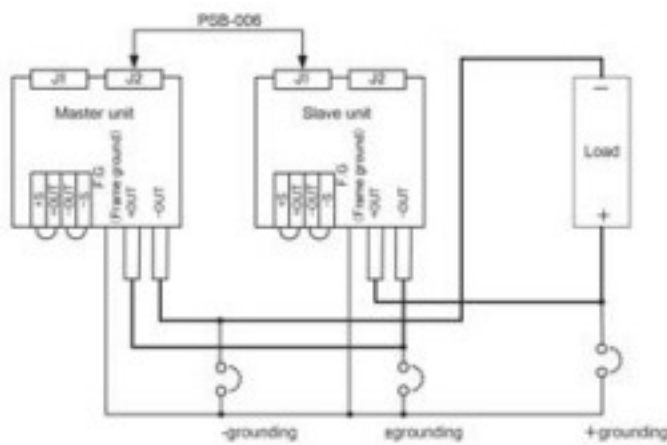

Series Connection

Hence, the PSB-2000 Series, with its multi-range output function and the power extension capability of series and parallel connections, is the high power density and high performance to cost ratio DC power supply, which provides

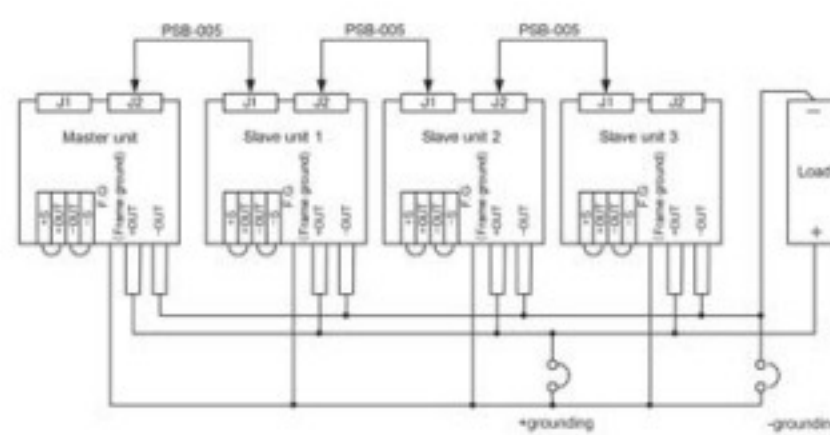

Parallel Connection

a wider range of power applications for any limited equipment space. The PSB-2000 Series is an ideal selection for testing DC power supply module, automobile lithium and lithium iron battery and electronic parts.

Programmable Multi-Range D.C. Power Supply



PSB-1000 Series



FEATURES

- * LCD Display and User-Friendly Menu-Typed Functional Interface
- * Voltage Rating : 40V/160V, Output Power Rating : 400W/800W
- * Constant Power Output for Multi-Range(V & I) Operation
- * The I/V Control Functions(Adjustable Slew Rate) are Suitable for Diode Characteristic Load & Surge Reducing
- * Sequence Function for Sequential D.C. Waveform Output
- * C.V/C.C Priority
- * Auto Run for Output or Sequence Function
- * Master-Slave Operation : 2 Units in Series/ 4 Units in Parallel
- * Synchronized Operation(Voltage Trigger, Trigger In/Trigger Out Signal)
- * Standard Interface : USB Host, LAN; Option : GPIB
- * Internal Sense Control(Disable/Front Panel/ Rear Panel)Function
- * LabVIEW Driver

PSB-106 Basic accessory kit :

M4 Terminal screws and washers x 2,
M8 Terminal bolts, Nuts and washers x 2,
Analog control protection dummy x 1,
Analog control lock level x 2, Short bar x 1



PSB-1000 is a series of Multi-Range DC Power Supply, whose maximum voltage output of 320V can be realized by placing 2 sets of 160V units in series connection. By connecting 4 sets of PSB-1800L units in parallel, the maximum current output of 320A can be achieved.

The PSB-1000 series is a bench-top power supply featuring user friendly interface, which can clearly display setting conditions and measurement results via LCD display and menu-typed functionality selection without referring to the user manual. All settings can be done by functionality keys, numerical keys, and speed dial keys. The 30A output capability from the front output terminal of the PSB-1000 series can better meet the requirements of laboratories and scientific R&D departments.

The PSB-1000 series features user friendly menu-typed functionality interface and its built-in functionalities can better meet industry's application requirements. Both front panel and rear panel output terminals of the PSB-1000 series facilitate researchers to access power output conveniently. The display panel adopts menu-typed functionality selection to help users quickly familiarize with settings and operation that is extremely suitable for on-site engineers and R&D engineers who deal with complicated functional setting requirements. Power On Configuration allows users to select previously set SEQ to carry out automatic execution as soon as power is turned on. For production lines demanding sequential power supply output application requirements, tremendous time can be saved by this function, which exempts users from resetting sequential power supply when power is turned on every single time.

Voltage Trigger allows users to set pulse signals for leading edge threshold and trailing edge threshold. VOLT TRIG can be applied to Automatic test system by providing output time for working voltage via BNC adapter. The Output Delay function facilitates users to respectively set action time for power output on and power output off for multiple sets of PSB-1000 so as to realize sequential power output applications.

The PSB-1000 series is equipped with multi range power output capability providing fourfold rated power output to meet customers' flexible application requirements.

SPECIFICATIONS

Model Name	PSB-1400L	PSB-1400M	PSB-1800L	PSB-1800M
OUTPUT RATING				
Output Voltage(V)	0~40	0~160	0~40	0~160
Output Current(A)	0~40	0~10	0~80	0~20
Output Power(W)	400W	400W	800W	800W
REGULATION (CV)				
Load Regulation (mV)	25	85	25	85
Line Regulation (mV)	23	83	23	83
REGULATION (CC)				
Load Regulation (mA)	45	15	85	25
Line Regulation (mA)	45	15	85	25
RIPPLE & NOISE (Noise Bandwidth 20MHz ; Ripple Bandwidth = 1MHz)				
CV p-p	60	60	80	80
CV rms	7	12	11	15
CC rms	80	20	160	40
PROGRAMMING ACCURACY				
Voltage (mV) 0.1% +	10	50	10	50
Current (mA) 0.1% +	20	10	40	20
MEASUREMENT ACCURACY				
Voltage (mV) 0.1% +	10	50	10	50
Current (mA) 0.1% +	20	10	40	20
RESPONSE TIME				
Raise Time (ms)	50	100	50	100
Fall Time(Full load) (ms)	50	150	50	150
Fall Time(No load) (ms)	500	1200	500	1200
Load Transient Recover Time(ms) (Load change from 50 to 100%)	1	1	1	1
PROGRAMMING RESOLUTION (By PC Remote Control Mode)				
Voltage (mV)	1	3	1	3
Current (mA)	1	1	2	1
MEASUREMENT RESOLUTION (By PC Remote Control Mode)				
Voltage (mV)	1	3	1	3
Current (mA)	1	1	2	1
SERIES AND PARALLEL CAPABILITY				
Parallel Operation	Up to 4 units including the master unit			
Series Operation	Up to 2 units including the master unit			
PROTECTION FUNCTION				
OVP (V)	4-44	5-176	4-44	5-176
OCP (A)	4-44	1-11	5-88	2-22
OHP	Turn the output off.			



PSB-1000 Series

SPECIFICATIONS

Model Name	PSB-1400L	PSB-1400M	PSB-1800L	PSB-1800M
FRONT PANEL DISPLAY ACCURACY (4 Digits)				
Voltage (mV)	0.1% + 20	100	20	100
Current (mA)	0.1% + 20	10	40	20
ENVIRONMENT CONDITION				
Operation Temp	0°C ~ 40°C			
Storage Temp	-25°C ~ 70°C			
Operating Humidity	20% ~ 85% RH; No condensation			
Storage Humidity	90% RH or less; No condensation			
OTHER				
Analog Control	Yes			
Interface	USB/LAN/GPIB (Option)			
Power Source	100Vac ~ 240Vac, 50Hz ~ 60Hz, single phase			
Dimension	214(W)×124(H)×350(D) mm			
Weight				
	Approx. 5.2kg	Approx. 5.2kg	Approx. 6.8kg	Approx. 6.8kg

ORDERING INFORMATION

PSB-1400L	40V/40A/400W Programmable Multi-Range D.C. Power Supply
PSB-1400M	160V/10A/400W Programmable Multi-Range D.C. Power Supply
PSB-1800L	40V/80A/800W Programmable Multi-Range D.C. Power Supply
PSB-1800M	160V/20A/800W Programmable Multi-Range D.C. Power Supply

ACCESSORIES :

CD ROM (User Manual, Programming Manual) x 1, Power cord for UL/CSA or PSE (Region dependent), Output terminal cover, Type A-B USB cable, PSB-106 Basic accessory kit : M4 terminal screws and washers x 2, M8 Terminal bolts, Nuts and washers x 2, Analog control protection dummy x 1, Analog control lock level x 2, Short bar x 1

OPTIONAL ACCESSORIES

PSW-001	Analog remote control connector kit
PSW-002	Simple IDC tool
PSW-003	Contact removal tool
PSB-101	Cable for 2 units of PSB-1000 in parallel connection
PSB-102	Cable for 3 units of PSB-1000 in parallel connection
PSB-103	Cable for 4 units of PSB-1000 in parallel connection
PSB-104	Cable for 2 units of PSB-1000 in series connection
PSB-105	GPIB card
PSB-106	Basic accessory kit : M4 Terminal screws and washers x 2, M8 Terminal bolts, Nuts and washers x 2, Analog control protection dummy x 1, Analog control lock level x 2, Short bar x 1
GRA-418-J	Rack Mount Kit (JIS)
GRA-418-E	Rack Mount Kit (EIA)
GTL-123	Test leads: 1x red, 1x black

FREE DOWNLOAD

Driver	Labview Driver
---------------	----------------

Rear Panel



PSB-101 Cable for 2 units of PSB-1000 in parallel connection



PSB-102 Cable for 3 units of PSB-1000 in parallel connection



PSB-103 Cable for 4 units of PSB-1000 in parallel connection



PSB-104 Cable for 2 units of PSB-1000 in series connection



PSB-105 GPIB card



Programmable Switching D.C. Power Supply



PSH-Series



FEATURES

- * Wide Input Voltage Range and High Power Factor (P.F)
- * High Efficiency and High Power Density
- * Constant Voltage and Constant Current Operation
- * Over Voltage , Over Current and Over Temperature Protection
- * Self-Test and Software Calibration
- * Output ON/OFF Control
- * Low Ripple and Noise
- * LCD Display
- * Built-in Buzzer Alarm
- * Standard Interface : RS-232C
- * Optional Interface : GPIB (IEEE-488.2)
- * LabVIEW Driver

Rear Panel



The PSH-Series is a single output from 360W to 1080W, programmable switching DC power supply. OVP, OCP and OTP protect the power supply and loads from unexpected conditions. Remote sensing adds an extra level of precision by compensating cable losses between loads. The bright LCD with simultaneous parameter outputs allows effortless operation. Self-test and software calibration features also reduce maintenance overhead. SCPI commands and LabVIEW driver access through the RS-232C or the optional GPIB interface allow remote control and ATE software development capability. Modular architecture, dedicated rear-panel output, and the 19 inch 4U rack mounting option ensure that the PSH-Series is optimized for large systems.

SPECIFICATIONS				
	PSH-2018A	PSH-3610A	PSH-3620A	PSH-3630A
OUTPUT				
Voltage	20V	36V	36V	36V
Current	18A	10A	20A	30A
REGULATION (C.V.)				
Load	≤ 0.1%+5mV	≤ 0.1%+5mV	≤ 0.1%+5mV	≤ 0.1%+5mV
Line	≤ 0.05%+5mV	≤ 0.05%+5mV	≤ 0.05%+5mV	≤ 0.05%+5mV
REGULATION (C.C.)				
Load	≤ 0.2%+5mA	≤ 0.2%+5mA	≤ 0.2%+10mA	≤ 0.2%+15mA
Line	≤ 0.2%+5mA	≤ 0.2%+5mA	≤ 0.2%+10mA	≤ 0.2%+15mA
RIPPLE & NOISE				
Voltage (mVrms)	≤ 10mVrms	≤ 10mVrms	≤ 10mVrms	≤ 10mVrms
Voltage (mVp-p)	≤ 100mVp-p	≤ 100mVp-p	≤ 100mVp-p	≤ 100mVp-p
	20Hz~20MHz	20Hz~20MHz	20Hz~20MHz	20Hz~20MHz
Current (mA rms)	≤ 0.2%	≤ 0.2%	≤ 0.2%+20mA	≤ 0.2%+40mA
RESOLUTION				
Voltage	10mV	10mV	10mV	10mV
Current	10mA	10mA	10mA	10mA
PROGRAM ACCURACY				
Voltage	≤ 0.05%+25mV	≤ 0.05%+25mV	≤ 0.05%+25mV	≤ 0.05%+25mV
Current	≤ 0.2%+30mA	≤ 0.2%+30mA	≤ 0.2%+30mA	≤ 0.2%+30mA
REARBACK RESOLUTION (Meter)				
Voltage	Same as Resolution	Same as Resolution	Same as Resolution	As Resolution
Current	Same as Resolution	Same as Resolution	Same as Resolution	As Resolution
REARBACK ACCURACY (Meter)				
Voltage	Same as Program Accuracy	Same as Program Accuracy	Same as Program Accuracy	As Program Accuracy
Current	Same as Program Accuracy	Same as Program Accuracy	Same as Program Accuracy	As Program Accuracy
REARBACK TEMP. COEFFICIENT				
Voltage (25 ±5°C)	≤ 100ppm/°C	≤ 100ppm/°C	≤ 100ppm/°C	≤ 100ppm/°C
RESPONSE (Rise/Fall) TIME				
Voltage Up (10%~90%)	≤ 150mS (≤95% rating load)	≤ 150mS (≤95% rating load)	≤ 150mS (≤95% rating load)	≤ 150mS (≤95% rating load)
Voltage Down (90%~10%)	≤ 150mS (≥10% rating load)	≤ 150mS (≥10% rating load)	≤ 150mS (≥10% rating load)	≤ 150mS (≥10% rating load)
RECOVERY TIME (50% Step Load Change From 25%~75%)				
CV Mode	≤ 2mS	≤ 2mS	≤ 2mS	≤ 2mS
PROTECTION				
OVP/OCP/OTP	✓	✓	✓	✓
Rush Current	✓	✓	✓	✓
OUTPUT ON/OFF CONTROL				
	✓	✓	✓	✓
INTERFACE				
Standard : RS-232C; Optional : GPIB				
POWER SOURCE				
AC90V~250V, 50/60Hz				
DIMENSIONS & WEIGHT				
	108(W)x142(H)x393(D) mm; Approx. 3.3kg	108(W)x142(H)x393(D) mm; Approx. 3.3kg	188(W)x142(H)x393(D) mm; Approx. 6.2kg	268(W)x142(H)x393(D) mm; Approx. 9.3kg

ORDERING INFORMATION

- PSH-2018A 360W Programmable Switching D.C. Power Supply
- PSH-3610A 360W Programmable Switching D.C. Power Supply
- PSH-3620A 720W Programmable Switching D.C. Power Supply
- PSH-3630A 1080W Programmable Switching D.C. Power Supply

ACCESSORIES :
User manual x 1 , Power cord x 1

OPTION
Opt. 01: GPIB Interface (Factory Installed)

- OPTIONAL ACCESSORIES**
- GRA-403 Rack Mount Kit
 - GTL-232 RS-232C Cable, 9-pin Female to 9-pin, null Modem for Computer
 - GTL-122 Test Lead, U-type to Alligator Test Lead, Max. Current 40A, 1200mm
 - GTL-248 GPIB Cable, Double Shielded, 2000mm

FREE DOWNLOAD

PC Software Driver PC Software including Data Log ; Remote Control Software
Labview Driver

Note : When Opt.01 GPIB interface is ordered, the standard interface RS-232C will be deleted.

Programmable Switching D.C. Power Supply



The PSP-Series is a single output, 200W, programmable switching DC power supply. OVL, OCL, OTP, and OPL protect the PSP-Series and its loads from unexpected conditions. The PSP-Series has a large LCD panel with output and parameter views and a key lock feature to prevent changing the settings. The PSP-Series is suitable for generic bench-top applications in laboratories and educational institutions.

PSP-603/405/2010



FEATURES

- * LCD Display
- * Output ON/OFF Control
- * 3 Step Fan Speed Control
- * Voltage/Current/Power Setting
- * Key Lock to Avoid Error Operation
- * Normal, +% & -% Output Operation Key
- * Standard Interface : RS-232C
- * Optional European Type Jack Terminal

European Type Jack Terminal



Rear Panel



SPECIFICATIONS			
OUTPUT			
Model	PSP-603	PSP-405	PSP-2010
Voltage	0 – 60V	0 – 40V	0 – 20V
Current	0 – 3.5A	0 – 5A	0 – 10A
VOLTAGE REGULATION			
Load	≤ 10mV	≤ 10mV	≤ 10mV
Line	≤ 0.05%	≤ 0.05%	≤ 0.05%
CURRENT REGULATION			
Load	≤ 5mA	≤ 5mA	≤ 5mA
Line	≤ 0.05%	≤ 0.05%	≤ 0.05%
RIPPLE			
Voltage (mVrms)	≤ 20mV	≤ 20mV	≤ 20mV
Current (mA rms)	≤ 10mA	≤ 10mA	≤ 10mA
RESOLUTION			
Voltage	20mV	10mV	10mV
Current	10mA	10mA	10mA
PROGRAM ACCURACY			
Voltage	± 0.05%rdg ± 4digits	± 0.05%rdg ± 3digits	± 0.05%rdg ± 3digits
Current	± 0.1%rdg + 5digits	± 0.1%rdg + 5digits	± 0.3%rdg + 10digits
READBACK (METER) RESOLUTION			
Voltage	Same as Resolution	Same as Resolution	Same as Resolution
Current	Same as Resolution	Same as Resolution	Same as Resolution
READBACK (METER) ACCURACY			
Voltage	Same as Program Accuracy	Same as Program Accuracy	Same as Program Accuracy
Current	Same as Program Accuracy	Same as Program Accuracy	Same as Program Accuracy
PROTECTION			
OVL/OCL/OPL/OTP	✓	✓	✓
OUTPUT ON/OFF CONTROL			
	✓	✓	✓
DISPLAY			
LCD			
INTERFACE (STANDARD)			
RS-232C			
POWER SOURCE			
AC 115V/230V ± 15% , 50/60Hz			
DIMENSIONS & WEIGHT			
225(W) x 100(H) x 305(D) mm ; Approx. 4kg			

ORDERING INFORMATION

PSP-603 200W Programmable Switching DC Power Supply
 PSP-405 200W Programmable Switching DC Power Supply
 PSP-2010 200W Programmable Switching DC Power Supply

ACCESSORIES :

User manual x 1, Power cord x 1, Test lead GTL-104A x 1, European test lead GTL-204A x 1

OPTIONAL ACCESSORIES

GTL-232A RS-232C Cable
 GRA-428 Rack Mount Kit, 19", 3U Size

FREE DOWNLOAD

PC Software RS-232C Remote Control Software

Switching D.C. Power Supply



The SPS-Series is a single output, 360W, switching DC power supply. OVP protects the SPS-Series and their loads from unexpected conditions. High regulation is maintained at 0.01%. Remote sensing adds an extra level of precision by compensating cable losses between loads. Turning the output On/Off from external device is available through Remote control terminals. The GPS-Series is an ideal solution for power-efficient bench-top or portable applications requiring high regulation.

SPS-1230/1820/2415/3610/606



FEATURES

- * Dual Measurement Display
- * 0.01 % High Regulation
- * Constant Voltage and Constant Current Operation
- * High Efficiency
- * High Power Density
- * Over Voltage Protection
- * Remote Output ON/OFF Control

SPECIFICATIONS					
OUTPUT					
	SPS-1230	SPS-1820	SPS-2415	SPS-3610	SPS-606
Voltage	0 ~ 12V	0 ~ 18V	0 ~ 24V	0 ~ 36V	0 ~ 60V
Current	0 ~ 30A	0 ~ 20A	0 ~ 15A	0 ~ 10A	0 ~ 6A
CONSTANT VOLTAGE OPERATION					
Regulation	Line regulation $\leq 5\text{mV}$ Load regulation $\leq 5\text{mV}$				
Ripple & Noise	$\leq 5\text{mVrms}$, 100mVp-p 20Hz ~ 20MHz				
Recovery Time	$\leq 500\mu\text{S}$ (50% Load change, Minimum load 0.5A)				
Temp. Coefficient	$\leq 100\text{ppm}/^\circ\text{C}$				
Output Range	0 to rating voltage continuously adjustable				
CONSTANT CURRENT OPERATION					
Regulation	Line regulation $\leq 3\text{mA}$ Load regulation $\leq 3\text{mA}$				
Ripple Current	$\leq 3\text{mA}$ (SPS-606) $\leq 5\text{mA}$ (SPS-3610) $\leq 10\text{mA}$ (SPS-2415) $\leq 10\text{mA}$ (SPS-1820) $\leq 30\text{mA}$ (SPS-1230)				
Output Range	0 to rating current continuously adjustable (HI/LO range switchable)				
METER					
Type	3 1/2 digit, 0.39" LED display				
Accuracy	$\pm (0.5\% \text{ of rdg} + 2\text{digits})$				
INSULATION					
Chassis and Terminal	20M Ω or above (DC 500V)				
Chassis and AC Cord	30M Ω or above (DC 500V)				
POWER SOURCE					
AC 115V/ 230V $\pm 15\%$, 50/60Hz					
DIMENSIONS & WEIGHT					
128(W) x 151(H) x 295(D) mm, Approx. 3.2kg					

Rear Panel



ORDERING INFORMATION

- SPS-1230** 360W Switching D.C. Power Supply
- SPS-1820** 360W Switching D.C. Power Supply
- SPS-2415** 360W Switching D.C. Power Supply
- SPS-3610** 360W Switching D.C. Power Supply
- SPS-606** 360W Switching D.C. Power Supply

ACCESSORIES :

User manual x 1 , Power cord x 1 , Test lead GTL-203A x 1

Multiple Output Dual Range D.C. Power Supply



SPD-3606

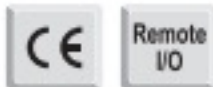

FEATURES

- * Three Independent, Isolated Output
- * CH1/CH2 : Dual Output Range of 30V/6A or 60V/3A
- * CH3 Adjustable Output : 0.1~5V/3A
- * High Efficiency Power Conversion (Up to 25% Than Traditional Power Supply)
- * Remote Output On/Off Control
- * OVP to Protect the DUT
- * OTP to Protect SPD-3606 for Reducing the Repair Rate
- * Automatically Switches AC 115V/230V Source
- * Full Safety Design: Reverse Polarity, CH3 Overload Protection, Safe Output Setting , C.C./C.V. Mode
- * Compact Size, Light Weight
- * Low Fan Acoustic Noise with Fan Speed Control Circuit
- * Voltage/Current Protection Knob(Optional)
- * Optional European Jack Type Terminal

European Type Jack Terminal



Rear Panel



GPS-001

Voltage/Current protection Knob



The SPD-3606 DC power supply provides 375W output capacity, three isolated outputs with dual-range for CH1 & CH2, highly efficient power conversion, low noise, high reliability, thorough protection, excellent value and a compact size. SPD-3606 creates a new bench mark for satisfying mainstream power supply demands. CH1 & CH2 offer dual-range output either at 30V/6A or 60V/3A per channel to accommodate a wide range of applications. SPD-3606 supports series and parallel tracking, allowing the CH1 and CH2 to be internally connected in series or parallel providing flexible output (30V/12A, 60V/6A, or 120V/3A). High power density and high power conversion efficiency lets SPD-3606 consume less energy making for a greener power supply. In addition, the high power density makes SPD-3606 weigh less than half and occupy much less space compared to linear power supplies. To avoid damage caused by improper operation, it also has OVP and OTP. The dual range AC input accepts both 115V and 230V inputs. When the instrument is on, devices can be connected and voltage/current levels can be adjusted safely from the front panel by turning off the output using the Output on/off key. The optional voltage/current protection knobs can be used to prevent accidentally changing the output levels. These knobs are useful for automated testing at fixed output levels, such as in assembly lines or product inspections.

SPECIFICATIONS	
OUTPUT RATINGS	
CH1/CH2 Independent	0 ~ 30V / 0 ~ 6A ; 0 ~ 60V / 0 ~ 3A
CH1/CH2 Series	0 ~ 60V / 0 ~ 6A ; 0 ~ 120V / 0 ~ 3A
CH1/CH2 Parallel	0 ~ 30V / 0 ~ 12A ; 0 ~ 60V / 0 ~ 6A
CH3	0.1 ~ 5V / 3A
VOLTAGE REGULATION	
Line	≤ 0.01% + 3mV
Load	≤ 0.01% + 5mV (rating current ≤ 6A) ≤ 0.01% + 8mV (rating current ≤ 12A)
Ripple & Noise	≤ 5mVrms (5Hz ~ 1MHz) ; ≤ 50mVpp (20Hz ~ 20MHz)
Recovery Time	≤ 100 μs (50% load change, minimum load 0.5A)
CURRENT REGULATION	
Line	≤ 0.2% + 3mA
Load	≤ 0.2% + 3mA
Ripple & Noise	≤ 3mA rms
TRACKING OPERATION	
Tracking Error	≤ 0.5% + 10mV of master
Series Regulation	≤ 300mV
Ripple & Noise	≤ 10mVrms (5Hz ~ 1MHz) ; ≤ 100mVpp (20Hz ~ 20MHz)
OUTPUT ON/OFF RESPONSE TIME	
Voltage Up (10% ~ 90%)	≤ 100ms (≤ 95% rating load)
Voltage Down (90% ~ 10%)	≤ 100ms (≥ 10% rating load)
OVP	
Accuracy	± (0.5% of reading + 0.5V)
METER	
Type	3 1/2 digit 0.5" LED display
Accuracy	± (0.5% of reading + 2 digits)
Resolution	100mV/10mA
INSULATION	
Chassis & Terminal	100MΩ or above (DC 1000V)
Chassis & AC code	100MΩ or above (DC 1000V)
TEMPERATURE COEFFICIENT	
Voltage	≤ 100ppm/°C + 3mV
Current	≤ 150ppm/°C + 3mA
REMOTE CONTROL	
Output On/Off	
FAN NOISE	
	≤ 50dB
OPERATION ENVIRONMENT	
Ambient temperature	0 ~ 40 °C ; Relative humidity ≤ 80%
STORAGE ENVIRONMENT	
Ambient temperature	-10 ~ 70 °C ; Relative humidity ≤ 70%
POWER SOURCE	
	AC 115V/230V ± 15%, 50/60Hz
DIMENSIONS & WEIGHT	
	255 (W) x 145 (H) x 265 (D) mm ; Approx. 6kg

ORDERING INFORMATION

SPD-3606 Multiple Output Dual Range D.C. Power Supply

ACCESSORIES :

User manual x 1, Power cord x 1, Test lead GTL-104A x 2, GTL-105A x 1
European Test Lead GTL-201A x 1, GTL-203A x 1, GTL-204A x 2

OPTIONAL ACCESSORIES

GPS-001 Voltage/Current protection Knob

Source Measure Unit



GSM-20H10

NEW



FEATURES

- ★ Maximum Output $\pm 210V/\pm 1.05A/22W$
- ★ Built-in 4 Sequence Output Modes (Stair, Log, SRC-MEM, Custom), up to 2500 Points
- ★ OVP /OTP Protection Function
- ★ 0.012% Basic Measure Accuracy with $6\frac{1}{2}$ -digit Resolution
- ★ Variable Sampling Speed
- ★ SDM (Source Delay Measure) Cycle
- ★ 2-, 4-, and 6-wire Remote V-source and Measure Sensing
- ★ Variable Display Digits
- ★ Built-in Limit Function
- ★ Built-in 5 Calculation Functions
- ★ 4.3" TFT LCD, Digital Number Keyboard
- ★ Built-in RTC Clock
- ★ Interface: RS-232, USBTMC, LAN, GPIB (Opt.)

GW Instek GSM-20H10 is a Source Measure Unit that provides highly stable DC power and instrument-grade $6\frac{1}{2}$ -digit multimeter measurements. While operating, it can be used as a voltage source, current source, voltmeter, ammeter, and ohmmeter, which is uniquely ideal for the evaluation of component characteristics and the test applications of production, including nanomaterials and components, semiconductor architecture, organic materials, high-efficiency illumination, passive components and material characteristics analysis, etc.

GSM-20H10 provides four-quadrant operation of $\pm 210V/\pm 1.05A/22W$. The first and third quadrants operate as power supplies to supply power to the load. The second and fourth quadrants function as loads to consume power internally. Voltage value, current value and resistance value can be measured while operating the power supply or load function with an accuracy of 0.012% and a resolution of $1\mu V/10pA/10\mu\Omega$.

With respect to sampling rate, GSM-20H10 supports a sampling rate of up to 50k points/second, which can accurately analyze the characteristics of the DUT. With the large 4.3-inch screen, all measurement settings, parameters and results can be completely displayed on the screen. The SDM (Source Delay Measure) function is provided to delay sampling when the signal changes so as to prevent the unstable signal from being captured and cause misjudgment. There are four built-in sequence output modes (Stair, Log, SRC-MEM, Custom), which can support up to 2500 points of sequence variation output.

Pertaining to protection, GSM-20H10 provides OVP/OTP modes. The design of OVP allows users to self-define the range of OVP. OTP can effectively prevent errors caused by temperature drift during the test process. For interfaces, this product supports standard SCPI commands and provides RS-232, USBTMC, LAN, GPIB (optional) interfaces to meet users' different interface needs.



GSM-20H10

Rear Panel



SM-01/SM-02 Digital I/O Adapter



ORDERING INFORMATION

GSM-20H10 with GPIB Source Measure Unit

GSM-20H10 Source Measure Unit

ACCESSORIES:

CD User manual x 1, Quick Start manual x 1, Test Lead GTL-207A x 1, Alligator Clip x 2

OPTIONAL ACCESSORIES

SM-01	Digital I/O Adapter, Convert DB15 to DB9 + 8-pin micro-DIN	GRA-450-J	Rack Mount kit
SM-02	Digital I/O Adapter, Convert DB15 to DB37 + 8-pin micro-DIN	GRA-450-E	Rack Mount kit
GTL-246	USB Cable (USB 2.0 A-B Type, approx.. 1200mm)		
GTL-248	GPIB Cable, 2000mm		

- NOTE:**
1. Speed = Normal (1 NPLC). For 0.1 PLC, add 0.005% of range to offset specifications, except 200mV, 1A ranges, add 0.05%. For 0.01 PLC, add 0.05% of range to offset specifications, except 200mV, 1A ranges, add 0.5%.
 2. Required to reach 0.1% of final value after Command is processed. Resistive load, 10 μ A to 100mA range.
 3. Overshoot into a fully resistive 100k Ω load, 10Hz to 1MHz BW, adjacent ranges: 100mV typical, except 20V/200V.
 4. Maximum time required for the output to begin to change following the receipt of: SOURce:VOLTage|CURRent <nr> Command.
 5. Reading rates applicable for voltage or current measurements, autorange off, filter off, display off, trigger delay = 0, and binary reading forms.
 6. Purely resistive load, 1 μ A and 10 μ A ranges <65ms.
 7. 1000 point sweep was characterized with the source on a fixed rang.
 8. Pass/Fail test performed using one high limit and one low math limit.
 9. Includes time to re-program source to a new level before making measurement.
 10. Time from falling edge of START OF TEST signal to falling edge of END OF TEST signal.
 11. Command processing time of: SOURce:VOLTage|CURRent: TRIGgered<nr> Command not included.

SPECIFICATIONS

MAXIMUM RANGE	Voltage	±210V										
	Current	±1.05A										
	Power	22W										
SOURCE	Voltage Resolution	1µV										
	Current Resolution	10pA										
	DC Voltage	Output Voltage	±21V / ±1.05A, ±210V / ±105 mA									
		Current Limit	Min. 0.1% of range									
		Programming Resolution & Accuracy *1	Range	±200.000mV	±2.00000V	±20.0000V	±200.000V					
			Resolution	1µV	10µV	100µV	1mV					
			Accuracy	±(0.02%+600µV)	±(0.02%+600µV)	±(0.02%+2.4mV)	±(0.02%+24mV)					
		Load Regulation	0.01% of range + 100µV									
		Line Regulation	0.01% of range									
		Overshoot	<0.1% typical (full scale step, resistive load, 10mA range)									
		Recovery Time (1000% Load Change)	<250µs (within 0.1% plus load regulation errors, 1A and 100mA compliance.)									
		Ripple and Noise	4mVrms(20Hz~1MHz) / 10mVpp(20Hz~1MHz)									
	Temperature Coefficient	±(0.15 x accuracy specification)/°C (0°~18°C & 28°~50°C)										
	DC Current	Output Current	±1.05A / ±21V, ±105 mA / ±210V									
		Voltage Limit	Min. 0.1% of range									
		Programmed Source Resolution & Accuracy *1	Range	±1.00000µA	±10.0000µA	±100.000µA	±1.00000mA	±10.00000mA	±100.000mA	±1.00000A		
			Resolution	10pA	100pA	1nA	10nA	100nA	1µA	10µA		
Accuracy			±(0.035%+600pA)	±(0.033%+2nA)	±(0.031%+20nA)	±(0.034%+200nA)	±(0.045%+2µA)	±(0.066%+20µA)	±(0.27%+900µA)			
Load Regulation		0.01% of range + 100pA										
Line Regulation		0.01% of range										
Overshoot		<0.1% typical (1mA step, RL = 10kΩ, 20V range)										
Temperature Coefficient		±(0.15 x accuracy specification)/°C (0°~18°C & 28°~50°C)										
Output Settling Time *2		100µs typical time										
Output Rise Time (±30%)	300µs, 200V range, 100mA compliance ; 150µs, 20V range, 100mA compliance											
General	DC Floating Voltage	Output can be floated up to ±250VDC										
	Remote Sense	Up to 1V drop per load lead										
	Compliance Accuracy	Add 0.3% of range and ±0.02% of reading to base specification										
	Range Change Overshoot *3	Adjacent range changes between 200mV, 2V and 20V ranges, 100mV typical										
	Minimum Compliance Value	0.1% of range										
	Command Processing Time *4	Autorange On:10ms, Autorange Off: 7ms										
	Input Resistance	>10 GΩ										
MEASUREMENT	Voltage	Measurement Resolution & Accuracy	Range	±200.000mV	±2.00000V	±20.0000V	±200.000V					
			Resolution	1µV	10µV	100µV	1mV					
			Accuracy	±(0.012%+300µV)	±(0.012%+300µV)	±(0.015%+1.5mV)	±(0.015%+10mV)					
	Temperature Coefficient	±(0.15 x accuracy specification)/°C (0°~18°C & 28°~50°C)										
	Current	Programmed Source Resolution & Accuracy *1	Range	±1.00000µA	±10.0000µA	±100.000µA	±1.00000mA	±10.00000mA	±100.000mA	±1.00000A		
			Resolution	10pA	100pA	1nA	10nA	100nA	1µA	10µA		
			Accuracy	±(0.029%+300pA)	±(0.027%+700pA)	±(0.025%+6nA)	±(0.027%+60nA)	±(0.035%+600nA)	±(0.055%+6µA)	±(0.22%+570µA)		
	Temperature Coefficient	±(0.1 x accuracy specification) / °C (0°~18°C & 28°~50°C)										
	Resistance	Range	Resolution	<2.00000Ω	2.00000Ω	20.0000Ω	200.000Ω	2.0000kΩ	20.000kΩ			
			Test current	---	---	100mA	10mA	1mA	100µA			
Accuracy			Source IACC+Meas.VACC	Source IACC+Meas.VACC	±(0.1%+0.003Ω), Normal ±(0.07%+0.001Ω), Enhanced	±(0.08%+0.03Ω), Normal ±(0.05%+0.01Ω), Enhanced	±(0.07%+0.3Ω), Normal ±(0.05%+0.1Ω), Enhanced	±(0.06%+3Ω), Normal ±(0.04%+1Ω), Enhanced				
Resolution			200.000kΩ	2.00000MΩ	20.0000MΩ	200.000MΩ	>200.000MΩ					
Test current			10µA	5µA	0.5µA	100nA	---					
Accuracy			±(0.07%+30Ω), Normal ±(0.05%+10Ω), Enhanced	±(0.11%+300Ω), Normal ±(0.05%+100Ω), Enhanced	±(0.11%+1kΩ), Normal ±(0.05%+500Ω), Enhanced	±(0.66%+10kΩ), Normal ±(0.35%+5kΩ), Enhanced	Source IACC+Meas.VACC					
Temperature Coefficient			±(0.15 x accuracy specification)/°C (0°~18°C & 28°~50°C)									
Source I mode, Manual OHMS			Total uncertainty = I source accuracy + V measure accuracy (4-wire remote sense)									
Source V mode, Manual OHMS			Total uncertainty = V source accuracy + I measure accuracy (4-wire remote sense)									
6-wire OHMS Mode			Available using active ohms guard and guard sense. Max. Guard Output Current: 50mA (except 1A range). Accuracy is load dependent									
Guard Output Impedance	<0.1Ω in ohms mode											
SYSTEM SPEED *5	Maximum Range Change Rate	75/second										
	Maximum Measure Auto Range Time	40ms (fixed source) *6										
	Sequence Reading Rates *7 (rdg./second) for 60Hz (50Hz)	Speed	NPLC / Trig Origin	Measure		Source-Measure *8		Source-Measure Pass/Fail test *8, *9		Measure Memory *9		
				TO MEMORY	TO GPIB	TO MEMORY	TO GPIB	TO MEMORY	TO GPIB	TO MEMORY	TO GPIB	
			Fast	0.01 / internal	2081 (2030)	1198 (1210)	1551 (1515)	1000 (900)	902 (900)	809 (840)	165 (162)	164 (162)
			488.2	0.01 / external	1239 (1200)	1079 (1050)	1018 (990)	916 (835)	830 (830)	756 (780)	163 (160)	162 (160)
			Medium	0.1 / internal	510 (433)	509 (433)	470 (405)	470 (410)	389 (343)	388 (343)	133 (126)	132 (126)
			488.2	0.1 / external	438 (380)	438 (380)	409 (360)	409 (365)	374 (333)	374 (333)	131 (125)	131 (125)
	Normal	1 / internal	59 (49)	59 (49)	58 (48)	58 (48)	56 (47)	56 (47)	44 (38)	44 (38)		
	488.2	1 / external	57 (48)	57 (48)	57 (48)	57 (47)	56 (47)	56 (47)	44 (38)	44 (38)		
	Single Reading Operation Rates (rdg./second) for 60Hz (50Hz)	Speed	NPLC / Trig Origin	Measure		Source-Measure *9		Source-Measure Pass/Fail test *8, *9				
TO GPIB				TO GPIB	TO GPIB	TO GPIB	TO GPIB	TO GPIB				
Fast(488.2)			0.01 / internal	256 (256)	79 (83)	79 (83)	79 (83)	79 (83)	79 (83)	79 (83)		
Medium(488.2)			0.1 / internal	167 (166)	72 (70)	72 (70)	72 (70)	72 (70)	72 (70)	72 (70)		
Normal(488.2)	1 / internal	49 (42)	34 (31)	34 (31)	34 (31)	34 (31)	34 (31)	34 (31)				
Component Interface Handler Time for 60Hz (50Hz) *8, *9	Speed	NPLC / Trig Origin	Measure		Source Pass/Fail test		Source-Measure Pass/Fail test *8, *11					
			TO GPIB	TO GPIB	TO GPIB	TO GPIB	TO GPIB	TO GPIB				
		Fast	0.01 / internal	1.04 ms (1.08 ms)	0.5 ms (0.5 ms)	0.5 ms (0.5 ms)	0.5 ms (0.5 ms)	0.5 ms (0.5 ms)	4.82 ms (5.3 ms)	4.82 ms (5.3 ms)		
		Medium	0.1 / internal	2.55 ms (2.9 ms)	0.5 ms (0.5 ms)	0.5 ms (0.5 ms)	0.5 ms (0.5 ms)	0.5 ms (0.5 ms)	6.27 ms (7.1 ms)	6.27 ms (7.1 ms)		
Normal	1 / internal	17.53 ms (20.9 ms)	0.5 ms (0.5 ms)	0.5 ms (0.5 ms)	0.5 ms (0.5 ms)	0.5 ms (0.5 ms)	21.31 ms (25.0 ms)	21.31 ms (25.0 ms)				
SYSTEM GENERAL	Load Impedance	Stable into 20,000pF typical										
	Differential Mode Voltage	250Vpk										
	Common Mode Voltage	250VDC										
	Common Mode Isolation	>10GΩ, <1000pF										
	Over Range	105% of range, source and measure										
	Max. Voltage Drop	5V										
	Max. Sense lead Resistance	1MΩ										
	Sense Input Impedance	>100GΩ										
	Guard Offset Voltage	<150µV, typical										
	Source Output Modes	Fixed DC level, Memory List (mixed function), Stair (linear and log)										
	Source Memory List	100 points max.										
	Memory Buffer	5,000 readings @ 5 digits (two 2,500 point buffers). Includes selected measured value(s) and time stamp. Lithium battery backup(3 yr + battery life)										
	Programmability	IEEE-488.2 (SCPI), RS-232 ; 5 user-definable power-up states plus factory default and *RST.										
	Digital I/O Connector	Active low input. Start of test, end of test, 3 category bits. ; +5V@ 300mA supply. ; 1 trigger input, 4 TTL/Relay Drive outputs (33V@500mA, diode)										
	Remote Interface	USB/GPIB/LAN/RS-232										
	Insulation	Chassis and terminal : 20MΩ or above (DC 500V) ; Chassis and AC cord : 30MΩ or above (DC 500V)										
	Operation Environment	Indoor use, Altitude: ≤ 2000m Ambient temperature: 0 – 40°C Relative humidity: ≤ 80%; Installation category: II, Pollution degree: 2										
Storage Environment	Temperature: -20°C – 70°C; Humidity: < 80%											
Input Power	100-240VAC, 50-60Hz											
Power Consumption	80W											
Dimensions & Weight	214 (W) x 86 (H) x 356.5 (D) mm, Approx. 4.8kg											

Source Measure Unit

GSM-20H10

POWER SUPPLIES

A. MAXIMUM OUTPUT: $\pm 210V/\pm 1.05A/22W$

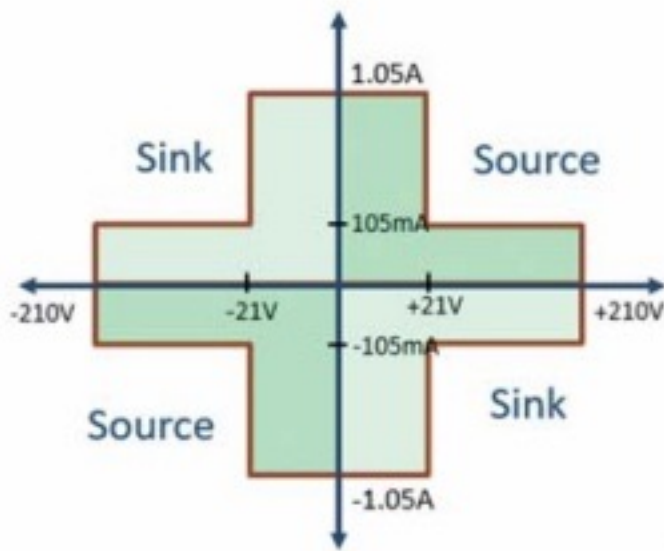

The power source output of the GSM-20H10 has two ranges.

The voltage range is ± 21 volts, and the current is $\pm 1.05A$.
The voltage range is ± 210 volts, and the current range is $\pm 105mA$.
The power capacity is 22W.

Provide a full range of four-quadrant measurement without duty cycle limit.

B. BUILT-IN 4 SEQUENCE OUTPUT MODES, UP TO 2500 POINTS

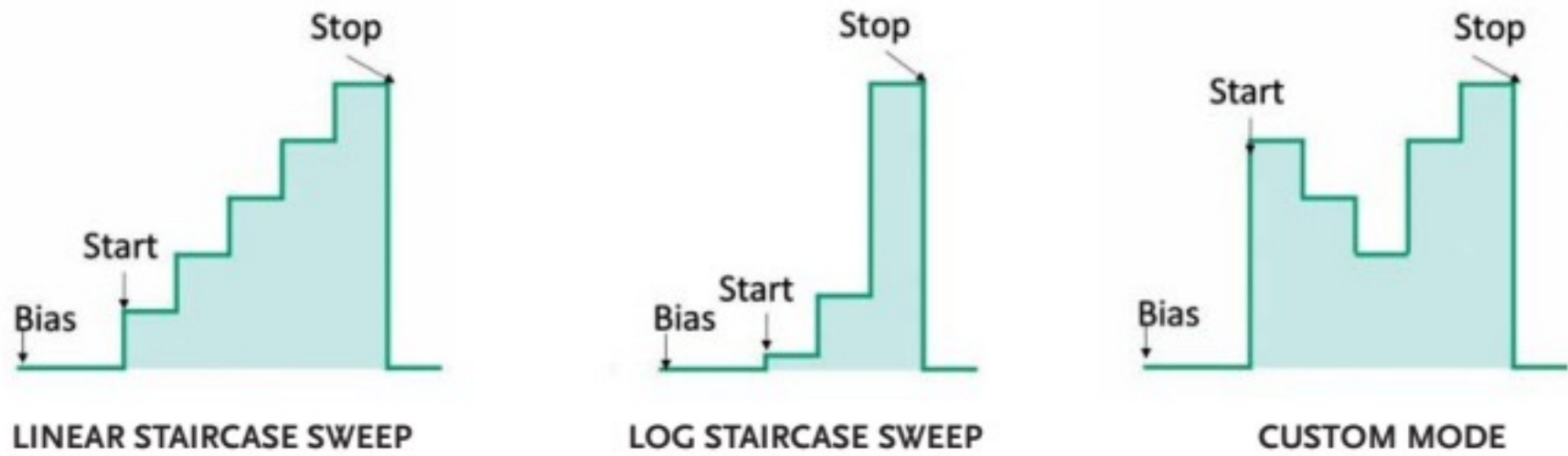

GSM-20H10 Source Measure Unit provides four sequence output modes: linear staircase, log staircase, SRC-MEM (source memory) and Custom (self-defined).

With these output modes, users can quickly generate output as needed. The total number of sequence points is 2,500.

C. OVP/OTP PROTECTION FUNCTION



In terms of protection, GSM-20H10 provides OVP/OTP protection modes; in the design of OVP, users can define the range of OVP, and the protection of OTP can effectively prevent errors caused by temperature drift during the test process.

D. 0.012% BASIC MEASURE ACCURACY WITH 6½-DIGIT RESOLUTION



GSM-20H10 provides a measurement accuracy of up to 0.012%, and provides a meter display function of up to 6½ digits, allowing users to have more accurate results when measuring small signals...

E. VARIABLE SAMPLING SPEED



SAMPLING MODE	FAST	MEDIUM	NORMAL	HIGH	OTHER
Speed, NPLC	0.01	0.1	1	10	User defined
Digit	3½	4½	5½	6½	Selectable

The sampling rate of GSM-20H10 is variable. Therefore, users can choose the sampling rate from 0.01 PLC to 10 PLC according to their needs.

Where NPLC represents the number of power line cycles, for example, AC power frequency is 50Hz, 1 PLC means 20ms, 2 PLC means 40ms, and so on.

F. SDM (SOURCE DELAY MEASURE) CYCLE

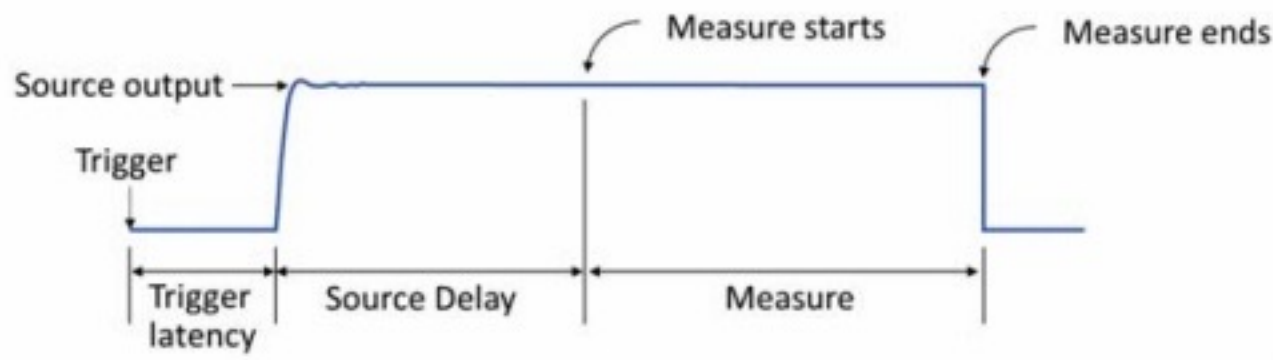

The initial state of the source output may be unstable. If the meter starts measuring after the source is output, users can set the source delay to start the meter measurement after passing the unstable period so as to obtain stable measurement results.

GSM-20H10 Source Measure Unit delay range is 0 to 9999.999 seconds.

G. 2-, 4-, AND 6-WIRE REMOTE V-SOURCE AND MEASURE SENSING

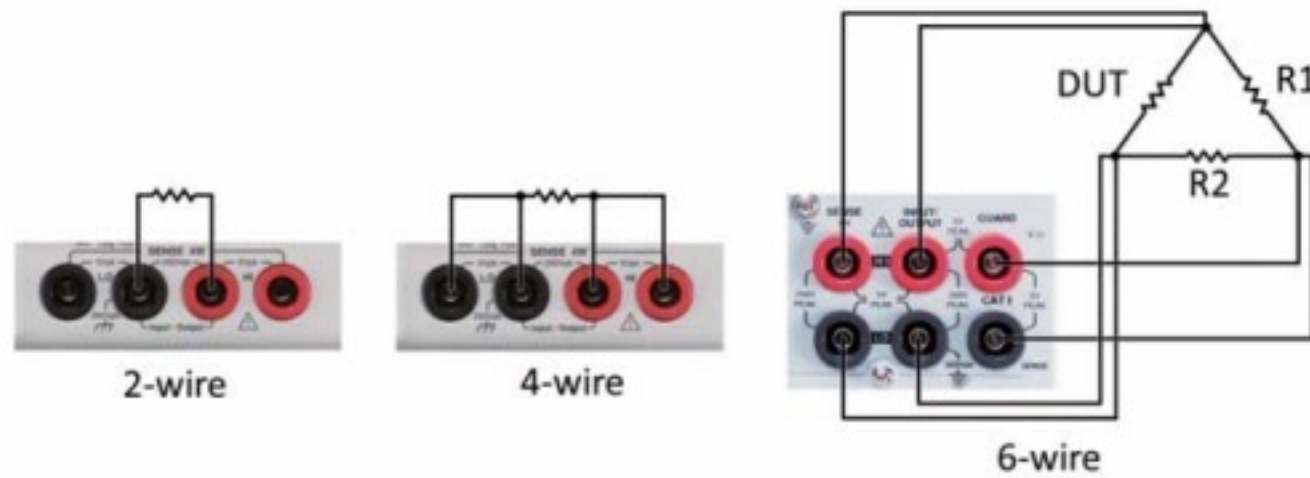

Other than 2-wire, GSM-20H10 also provides 4-wire and 6-wire resistance measurements.

4-wire measurement eliminates the effect of lead resistance, realizing accurate measurement of small resistances below 100ohm at high currents.

6-wire combining 4-wire connection and the protection of ohm characteristics eliminate the effects of internal parallel resistance, realizing the resistance measurement of a tiny wire.

H. VARIABLE DISPLAY DIGITS



The display bits of GSM-20H10 are variable. Therefore, users can choose the number of display bits among 3.5, 4.5, 5.5, and 6.5 bits according to their needs.

I. BUILT-IN LIMIT FUNCTION



GSM-20H10 has three built-in Pass/Fail limit line tests with a total of 11 sets.

J. BUILT-IN 5 CALCULATION FUNCTIONS

- Power = V•I
- CompOhms = $\frac{(V2-V1)}{(I2-I1)}$
- Vceoff(%) = $\left[\frac{\Delta R}{(R2+\Delta V)} \right] * 100\%$
- VarAlpha, $\alpha = \frac{\log(I2+I1)}{\log(V2+V1)}$
- Dev = $\left[\frac{(X-Y)}{Y} \right] * 100\%$

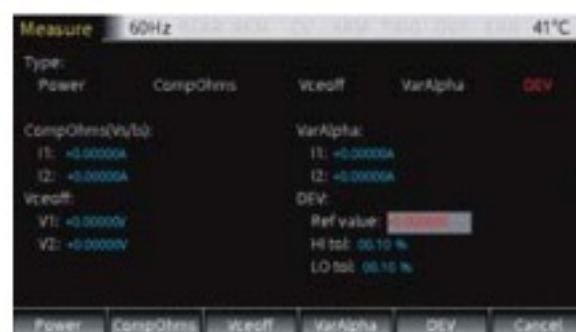

GSM-20H10 provides five built-in calculation functions: Power, Offset Compensation Ohms, Voltage Coefficient, Varistor Alpha, and Percent Deviation.

Programmable High Precision D.C. Power Supply



PPH-1503



PPH-1503D/1506D/1510D



FEATURES

- ★ 3.5" TFT LCD Display
- ★ High Measurement Resolution: 1mV/0.1μA for 5mA range.
- ★ Transient Recovery Time: ≤40μs within 100mV; <80μs within 20mV
- ★ Current Sink Function
- ★ Pulse Current Measurement (Pulse width min.: 33μs)
- ★ Long Integration Current Measurement
- ★ Built-in DVM Measurement Function
- ★ Sequence Function (Sequence power output)
- ★ Built-in Battery Simulation Function (CH1 of PPH-15xxD)
- ★ OVP, OCP, OTP & Temperature Display for Heat Sink
- ★ Support USB (Device & Host)/GPIB/LAN
- ★ Five Groups of Save/Recall Setting
- ★ External Relay Control

PPH-1503 Rear Panel



PPH-1503D/1506D/1510D Rear Panel



PPH-Series high precision measurement capability achieves the maximum resolution of 1mV/0.1μA and the smallest pulse current width of 33μs that satisfy customers' measurement application requirements of high resolution and pulse current. Fast load current variation will result in voltage sag for general power supplies that will have an impact on DUT's internal circuit operation. PPH-Series is equipped with the excellent transient recovery time, which can, in less than 40μs, recover the output voltage to within 100mV of the previous voltage output when the current level changes from 10% to 100% of the full scale. Furthermore, conventional power supplies do not have sufficient response speed to promptly respond to set voltage value once the set voltage is changed. PPH-15xxD has a rise time of 0.2ms and a fall time of 0.3ms, which are 100 times faster than that of conventional power supplies. Therefore, PPH-15xxD can provide DUT with a stable output voltage even when DUT is operating under large transient current output. The internal high-speed sampling circuit design of PPH-15xxD, with the sample rate of 64K, can conduct pulse current measurement without using a current probe and oscilloscope. The current read back accuracy is 0.2%+1μA (equals to 11μA) at 5mA range, and the read back resolution is 0.1μA that allow DUT to be measured with a high accuracy level. Unlike battery, general power supplies, which do not have the characteristics of fast transient recovery time, can not maintain a stable power supply for cellular phone, wireless device, and wearable device which produce large transient pulse current load for hundreds of μs to dozens of ms when in use. PPH-15xxD, different from general power supplies, has the characteristics of fast transient recovery time. While simulating battery to output pulse current, PPH-15xxD can quickly compensate the voltage drop caused by pulse current. PPH-15xxD's CH1 has the built-in battery simulation function, which can define output impedance settings so as to accurately simulate battery's impedance characteristics during battery discharge. Fast transient recovery time and built-in battery simulation function together facilitate PPH-15xxD to accurately simulate battery's real behavior pattern so as to conduct product tests.

PPH-15xxD is not only suitable for simulating battery, charger and supplying power to DUT, but also ideal for simulating an electronic load to conduct discharge tests with its sink current capability. The sink current function allows PPH-15xxD to simulate a voltage source with the sink current capability. The maximum sink current of PPH-15xxD's CH1 is 3.5A and for CH2 is 3A. Long integration current measurement can be utilized to conduct average current measurement for periodical pulse current in a long period of time that is applied to analyze power consumption for a period of time. One of the applications is to measure the average power consumption of a cellular phone in use so as to conduct the internal RF module parameter analysis. The maximum pulse current measurement range of CH1 is 5A and for CH2 is 3A. The built-in sequence function of CH1 provides users with 1000 steps to edit sequential outputs, including voltage, current and execution time. The built-in DVM function of CH2 has a voltage range from 0 to +20VDC that saves users the cost of purchasing an additional voltage meter.

PPH-15xxD provides OTP function and shows heat sink temperature on the upper right corner of the display screen. Other than that, features such as five sets of system setting values for the SAVE/RECALL function, 10 sets of Power On Setup Settings, Key-Lock function to prevent unauthorized inputs, temperature-controlled fan to reduce noise, hardcopy to save screen information, and external relay control device together augment PPH-15xxD's usability. PPH-Series supports test requirements of Profile1, Profile2 and Profile3 from USB Power Delivery(PD) constructed by USB-IF association.

SELECTION GUIDE

Model	PPH-1503	PPH-1503D	PPH-1506D	PPH-1510D
Channel	1	2	2	2
Dual Range Output	Channel 1: 0~15V/0~3A or 0~9V/0~5A Channel 2: NA	0~15V/0~3A or 0~9V/0~5A 0~12V/0~1.5A	0~15V/0~3A or 0~9V/0~5A 0~12V/0~3.0A	0~15V/0~3A or 0~9V/0~5A Rear Terminal: 0~10A(0~4.5V) 0~12V/0~3.0A
Display	3.5 Inch TFT LCD	3.5 Inch TFT LCD	3.5 Inch TFT LCD	3.5 Inch TFT LCD
Current Measurement Range	5A/5mA	5A/500mA/5mA(CH1)	5A/500mA/5mA(CH1)	10A/500mA/5mA(CH1)
CV&CC	✓	✓	✓	✓
Built-in DVM Measurement Function	✓	✓ (CH2)	✓ (CH2)	✓ (CH2)
Pulse Current Measurement	✓	✓	✓	✓
Long integration Current Measurement	✓	✓	✓	✓
Battery Simulation	NA	✓ (CH1)	✓ (CH1)	✓ (CH1)
Automated Sequential Output	✓	✓ (CH1)	✓ (CH1)	✓ (CH1)
High Measurement Resolution	✓ (1mV/0.1 μA)	✓ (1mV/0.1 μA)	✓ (1mV/0.1 μA)	✓ (1mV/0.1 μA)
Sink Current Capability	✓ (Max : 2A)	✓ (Max : 3.5A)	✓ (Max : 3.5A)	✓ (Max : 3.5A)
Selectable Output From Front or Rear Panel	✓	✓	✓	✓
Relay Output Control	✓	✓	✓	✓
Memory	5 Sets	5 Sets	5 Sets	5 Sets
Sample Rate	60K	64K	64K	64K
Lock Function	✓	✓	✓	✓
Protection Function	OVP/OTP/OCP	OVP/OTP/OCP	OVP/OTP/OCP	OVP/OTP/OCP
Four Wire Output Open Circuit Protection	NA	✓	✓	✓
Temperature Display for Heat Sink	NA	✓	✓	✓
Standard Interface:	GPIB	✓	✓	✓
LAN, USB, Analog Control	USB	✓ (CDC)	✓ (TMC)	✓ (TMC)
Interface	LAN	✓	✓	✓

ORDERING INFORMATION

- PPH-1503 (0~15V/0~3A or 0~9V/0~5A)High Precision DC Power Supply
- PPH-1503D (CH1:0~15V/0~3A or 0~9V/0~5A;CH2:0~12V/0~1.5A)High Precision Dual Channel Output DC Power Supply
- PPH-1506D (CH1:0~15V/0~3A or 0~9V/0~5A;CH2:0~12V/0~3A)High Precision Dual Channel Output DC Power Supply
- PPH-1510D (CH1:0~15V/0~3A or 0~9V/0~5A,0~4.5V/0~10A(Rear terminal);CH2:0~12V/0~3A)High Precision Dual Channel Output DC Power Supply

ACCESSORIES :

CD (User manual x1, Quick start manual x1), Power cord (Region dependent), Test lead GTL-207A x 1, GTL-203A x 1, GTL-204A x 1

OPTIONAL ACCESSORIES

GTL-246 USB Cable (USB 2.0, A-B Type) GRA-450-J Rack Mount kit GRA-450-E Rack Mount kit

SPECIFICATIONS								
Model	PPH-1503		PPH-1503D		PPH-1506D		PPH-1510D	
OUTPUT RATING								
Number of Output Channel	1		2		2		2	
Channel No.	Ch 1		Ch 1		Ch 1		Ch 1	
Power	45W		45W		45W		45W	
Voltage	0 ~ 15V or 0 ~ 9V		0 ~ 15V or 0 ~ 9V		0 ~ 15V or 0 ~ 9V		0 ~ 15V or 0 ~ 9V	
Current	0 ~ 3A or 0 ~ 5A		0 ~ 3A or 0 ~ 5A		0 ~ 3A or 0 ~ 5A		0 ~ 3A or 0 ~ 5A Rear: 0~10A (under 0~4.5V)	
Output Voltage Rising Time	0.15ms (10% ~ 90%)		0.20ms (10% ~ 90%)		0.20ms (10% ~ 90%)		0.20ms (10% ~ 90%)	
Output Voltage Falling Time	0.65ms (90% ~ 10%)		0.30ms (90% ~ 10%)		0.30ms (90% ~ 10%)		0.30ms (90% ~ 10%)	
STABILITY								
Voltage	0.01%+0.5mV		0.01%+3.0mV		0.01%+3.0mV		0.01%+3.0mV	
Current	0.01%+50 μA		—		—		—	
REGULATION (CV)								
Load	0.01%+2mV		0.01%+2mV		0.01%+2mV		0.01%+2mV	
Line	0.5mV		0.5mV		0.5mV		0.5mV	
REGULATION (CC)								
Load	0.01%+1mA		0.01%+1mA		0.01%+1mA		0.01%+1mA	
Line	0.5mA		0.5mA		0.5mA		0.5mA	
RIPPLE & NOISE (20Hz~20MHz)								
CV p-p	8mV		≤ 5A : 8mVp-p(20Hz~ 20MHz)		≤ 5A : 8mVp-p(20Hz~ 20MHz)		≤ 5A : 8mVp-p(20Hz~ 20MHz)	
CV rms	1mV		3mV(0~1MHz)		3mV(0~1MHz)		3mV(0~1MHz)	
CC rms	—		—		—		—	
PROGRAMMING ACCURACY								
Voltage	0.05%+10mV		0.05%+10mV		0.05%+10mV		0.05%+10mV	
Current(Ch1:5A,10A/CH2:1.5A,3A)	0.16%+5mA		0.16%+5mA(5A/1.5A)		0.16%+5mA(5A/3A)		0.16%+5mA(5A/3A)	
Current (500mA)	—		0.16%+0.5mA		0.16%+0.5mA		0.16%+0.5mA	
Current (5mA)	—		0.16%+5μA		0.16%+5μA		0.16%+5μA	
REDAKBACK ACCURACY								
Voltage	0.05%+3mV		0.05%+3mV		0.05%+3mV		0.05%+3mV	
Current(Ch1:5A,10A/CH2:1.5A,3A)	0.2%+400μA(5A)		0.2%+400μA(5A)		0.2%+400μA(5A)		0.2%+400μA(5A)	
Current (500mA)	—		0.2%+100μA		0.2%+100μA		0.2%+100μA	
Current (5mA)	0.2%+1μA		0.2%+1μA		0.2%+1μA		0.2%+1μA	
RESPONSE TIME								
Transient Recovery Time (Response to 100% Load Change)	<40μs (within 100mV) <80μs (within 20mV)		<40μs (within 100mV, Rear) <50μs (within 100mV, Front) <80μs (within 20mV)		<40μs (within 100mV, Rear) <50μs (within 100mV, Front) <80μs (within 20mV)		<40μs (within 100mV, Rear) <50μs (within 100mV, Front) <80μs (within 20mV)	
PROGRAMMING RESOLUTION								
Voltage	2.5mV		2.5mV		2.5mV		2.5mV	
Current (5A range)	1.25mA		1.25mA(5A)		1.25mA(5A)		1.25mA(5A)	
Current (500mA range)	—		0.125mA		0.125mA		0.125mA	
Current (5mA range)	—		1.25μA		1.25μA		1.25μA	
REDAKBACK RESOLUTION								
Voltage	1mV		1mV		1mV		1mV	
Current (5A range)	0.1mA		0.1mA(5A)		0.1mA(5A)		0.1mA(5A)	
Current (500mA range)	—		0.01mA		0.01mA		0.01mA	
Current (5mA range)	0.1μA		0.1μA		0.1μA		0.1μA	
PROTECTION FUNCTION								
OVP Accuracy	50mV		Ch1: 0.8V		Ch2: 50mV		Ch1: 0.8V	
OVP Resolution	10mV		10mV		10mV		10mV	
DVM								
DC Readback Accuracy(23°C±5°C)	±0.05%+3mV		±0.05%+3mV		±0.05%+3mV		±0.05%+3mV	
Readback Resolution	1mV		1mV		1mV		1mV	
Input Voltage Range	0 ~ 20VDC		0 ~ 20VDC		0 ~ 20VDC		0 ~ 20VDC	
Maximum Input Voltage	—		-3V, +22V		-3V, +22V		-3V, +22V	
Input Resistance and Capacitance	100000M Ω		20M Ω		20M Ω		20M Ω	
PROGRAMMABLE OUTPUT RESISTANCE								
Range	0.001 Ω ~ 1.000 Ω		0.001 Ω ~ 1.000 Ω		0.001 Ω ~ 1.000 Ω		0.001 Ω ~ 1.000 Ω	
Programming Accuracy	—		0.5% + 10 m Ω		—		0.5% + 10 m Ω	
Resolution	1m Ω		1m Ω		1m Ω		1m Ω	
PULSE CURRENT MEASUREMENT								
Trigger Level	5mA ~ 5A, 5mA/Step		5mA ~ 5A, 5mA/Step		5mA ~ 5A, 5mA/Step		5mA ~ 5A, 5mA/Step	
High Time/low Time/ Average Time	33.3μs ~ 833ms, 33.3μs/Step		33.3μs ~ 833ms, 33.3μs/Step		33.3μs ~ 833ms, 33.3μs/Step		33.3μs ~ 833ms, 33.3μs/Step	
Trigger Delay	0 ~ 100ms, 10μs/Steps		0 ~ 100ms, 10 μ s/Steps		0 ~ 100ms, 10 μ s/Steps		0 ~ 100ms, 10μs/Steps	
Average Readings	1 ~ 100		1 ~ 100		1 ~ 100		1 ~ 100	
Long Integration Pulse Time	1S ~ 63S		1S ~ 63S		1S ~ 63S		1S ~ 63S	
Long Integration Measurement Time	850ms(60Hz)/840ms(50Hz)~60s, or Auto time 16.7ms/Steps(60Hz), 20ms/Steps(50Hz)		850ms(60Hz)/840ms(50Hz)~60s, or Auto time 16.7ms/Steps(60Hz), 20ms/Steps(50Hz)		850ms(60Hz)/840ms(50Hz)~60s, or Auto time 16.7ms/Steps(60Hz), 20ms/Steps(50Hz)		850ms(60Hz)/840ms(50Hz)~60s, or Auto time 16.7ms/Steps(60Hz), 20ms/Steps(50Hz)	
Long Integration Trigger Mode	Rising, Falling, Neither		Rising, Falling, Neither		Rising, Falling, Neither		Rising, Falling, Neither	
OTHERS								
Output Terminal	Front/Rear Panel		Front/Rear Panel		Front/Rear Panel		Front/Rear Panel	
DVM Input	Front/Rear Panel		—		Front Panel		—	
Relay Control Connector	150mA/15V, 5V output, 100mA		150mA/15V, 5V output, 100mA		150mA/15V, 5V output, 100mA		150mA/15V, 5V output, 100mA	
Operation Temperature	0 ~ 40°C		0 ~ 40°C		0 ~ 40°C		0 ~ 40°C	
Operation Humidity	< 80%		< 80%		< 80%		< 80%	
Storage Temperature	-20°C ~ 70°C		-20°C ~ 70°C		-20°C ~ 70°C		-20°C ~ 70°C	
Storage Humidity	< 80%		< 80%		< 80%		< 80%	
PC REMOTE INTERFACES								
Standard	GPIB/USB/LAN		GPIB/USB/LAN		GPIB/USB/LAN		GPIB/USB/LAN	
CURRENT SINK CAPACITY								
Sink Current Rating	2A (Vout ≤ 5V); 2A-0.1*(Vout-5) (Vout>5V)		Ch1:0~4V:3.5A; 4~15V:3.5A-(0.25A/V) *(Vset-4V)		Ch2: 0~5V:2A; 5~12V:2A-(0.1A/V) *(Vset-5V)		Ch1:0~4V:3.5A; 4~15V:3.5A-(0.25A/V) *(Vset-4V)	
MEMORY								
Save/Recall	5 Sets		5 Sets		5 Sets		5 Sets	
POWER								
Input Power	90 ~ 264VAC ; 50/60Hz		90 ~ 264VAC ; 50/60Hz		90 ~ 264VAC ; 50/60Hz		90 ~ 264VAC ; 50/60Hz	
Power Consumption	150W		160W		160W		160W	
DIMENSIONS & WEIGHT								
	222(W)x86(H)x363(D)mm; Approx 4.2kg		222(W)x86(H)x363(D)mm; Approx 4.5kg		222(W)x86(H)x363(D)mm; Approx 4.5kg		222(W)x86(H)x363(D)mm; Approx 4.5kg	

Programmable High Precision D.C. Power Supply

A. FAST RESPONSE TO LOAD AND VOLTAGE CHANGES



PPH-Series

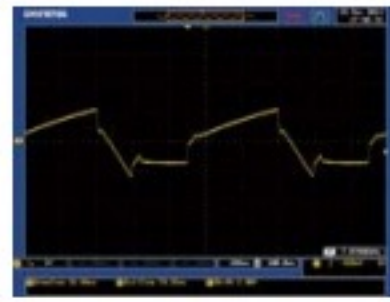

Conventional Power Supply

When DUT such as cellular phone switches to idling, receiving or transmitting mode, the current drawn from power supply changes over tenfold. The sudden current change will cause the supplied voltage to drop as well. The conventional power supply is considered a dull device since it will take several milliseconds for the dropped voltage to return to the original level. PPH-Series is designed to simulate battery response when a significant voltage drop occurs. Recovery time of 40 μ s or less is guaranteed when the maximum voltage drop is within 100mV.

C. PULSE CURRENT MEASUREMENTS

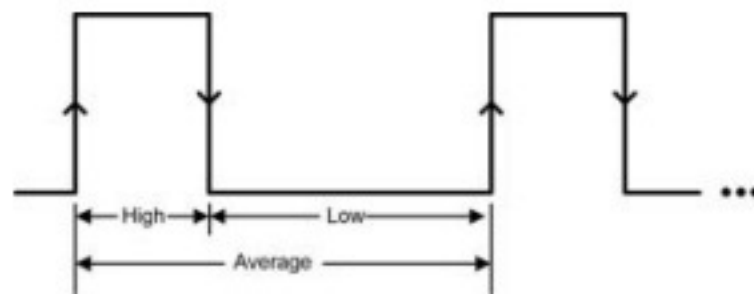

Pulse Current Measurement

PPH-Series DC power supply can perform current measurements for pulsing loads. To avoid false pulse detection, users can use a trigger level of up to 5A. All pulses, noise or other transients that are less than set trigger level will be ignored. The manual integration time range setting is 33 μ s to 833,333 μ s. Pulse current measurement can measure transient current consumption to provide the information for the allocation of power supply system for products' preliminary design, i.e. power supply circuits, battery selections for clients' product analyses. Portable communications products, i.e. RF modules and designs based upon blue tooth system can better use pulse current measurement function.

E. BUILT-IN DIGITAL VOLTMETER



DVM Input for PPH-Series

The built-in Digital Volt-Meter (DVM) of PPH-Series has a dedicated input terminal located on the front panel. With the DC voltage measurement range from 0 to +20VDC, PPH-Series not only provides power supply for DUT but also measures the voltage on DUT. The read back accuracy reaches $\pm(0.05\%+3mV)$ and read back resolution is 1mV. Users are able to save the cost of purchasing an extra voltage meter. Furthermore, DVM measurements can be remotely controlled by SCPI commands via a PC.

B. SINK CURRENT FUNCTION

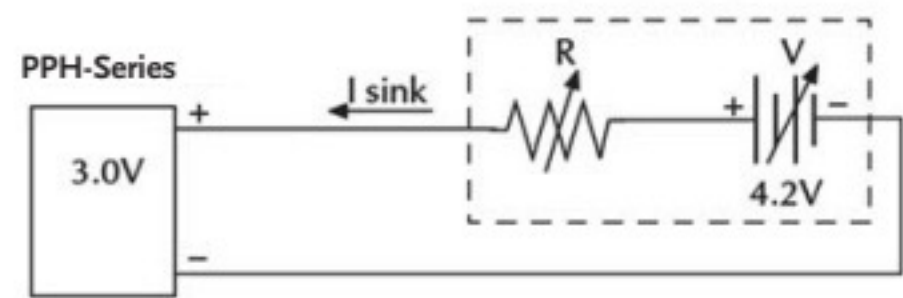

PPH-Series and an Electrical Potential Circuit

When connecting with an electric potential circuit and the output voltage of the tested electric potential circuit is greater than that of PPH-Series by approximately 0.3V to 2.5V, PPH-Series will automatically convert its power supply role to the sink current role acting as a load of voltage source. At this time, the voltage setting of PPH-Series can be regarded as the CV setting of an electronic load. A single PPH-Series can be used to charge battery and to simulate battery's load to consume power without extra instruments. PPH-Series is ideal for tests on battery and portable charger.

D. LONG INTEGRATION CURRENT MEASUREMENT



Long Integration Current Measurement

Long integration current measurement is to measure the average current of periodical pulse current in a long period of time. The measured pulse current must be a complete periodical waveform or multiple complete periodical waveforms. The total measurement time is up to 60 seconds. Measurements can be taken from pulse's positive edge trigger or negative edge trigger. Users can also take measurements from the beginning of power output. Long integration current measurement is to analyze power consumption for a period of time. For instance, users can measure the average power consumption of a cellular phone in use to analyze its internal RF module parameters.

F. MEASUREMENTS FOR POWER CONSUMPTION ANALYSIS



Voltage and Current Waveforms of the Receiving Signals of a Cellular Phone

One particular requirement of power consumption for portable wireless communications devices is Pulse Current. Portable devices such as cellular phones must transmit and receive (detect) signal periodically by drawing pulse current instead of constant current from battery to ensure devices' sound connection in network. To analyze the transient power consumption of a DUT, the peak of short pulse current and average current measurements over a long period of time are crucial. PPH-Series provides pulse current and long integration functions, the former can measure the peak value of a pulse, the latter can measure the average value of pulses. PPH-Series provides DUT with pulse current measurement and analyzes the transient power consumption to qualify the device for specified power consumption requirements.

G. EXTERNAL RELAY CONTROL

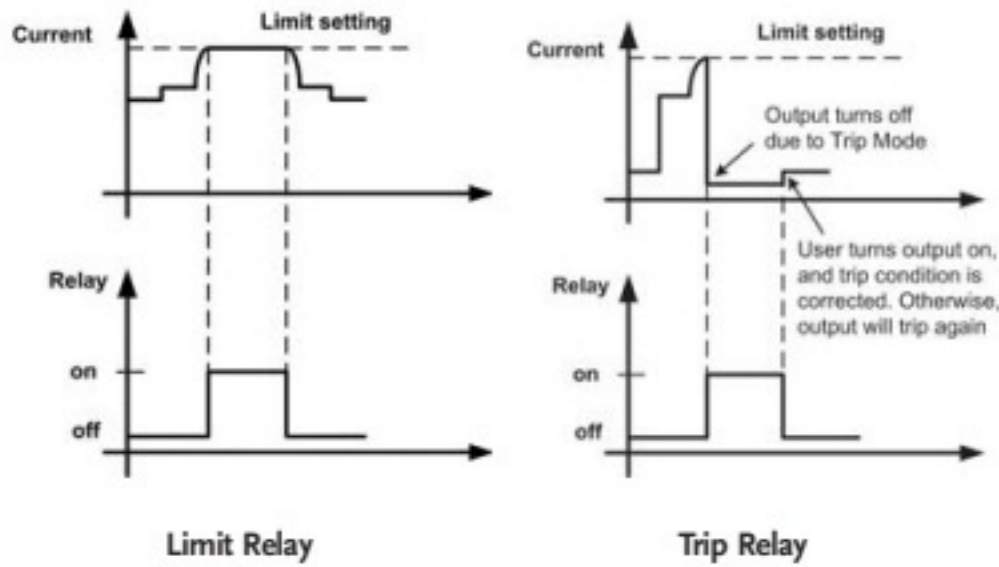

PPH-Series provides Limit relay and Trip relay modes and is equipped with corresponding output ports, in which output signals control external relay. Under Limit relay mode and the current limit is reached, PPH-Series will switch from Constant Voltage to Constant Current automatically. Under "Trip relay" mode and the current limit is reached, PPH-Series will turn output off. Furthermore, External Relay control can be used if users simultaneously use other devices for test system. When "Limit Relay" mode is selected and the current limit is reached, External

H. SEQUENCE FUNCTION

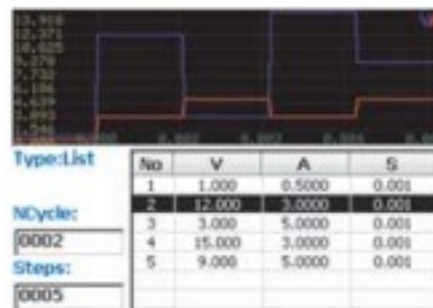

Functional Setting Page for Sequence Function

For the practical usage, PPH-15xxD can be programmed to output a sequential voltage variation according to the requirements. There are 1000 steps for users to edit output voltage, current and execution time. Programmable execution time range is from 0.001 second to 3600 seconds and the resolution is 0.001 second. Programmable recurring frequency is from 1 to 9999 or it can be set to infinite execution (set recurring frequency to 0).

Relay Can be Driven by Using Internal +5V or External Power Source :

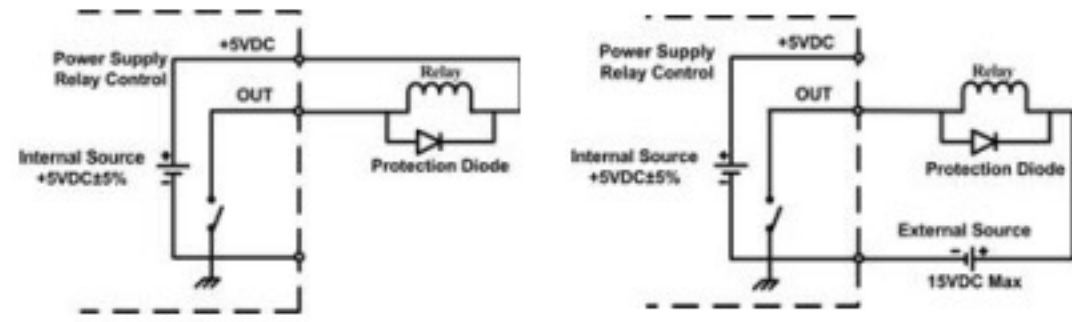

+5VDC Relay Output

Using the +5VDC relay output to drive an external relay. Ensure the current does not exceed 150mA.

External Power Source

Using an external power source to drive the external relay. The voltage of the source can not exceed 15V and the current can not exceed 150mA.

Relay control signal will go high and will return back to the low level when the current level goes back below the constant current setting. When "Trip Relay" mode is selected and the current limit is reached, the relay control signal will go high and the output is disabled. When the output goes back on and the current is less than the current setting, the relay control signal will back to the low level. Users can use relay control signal to control other devices for test system.

I. BATTERY SIMULATION FUNCTION

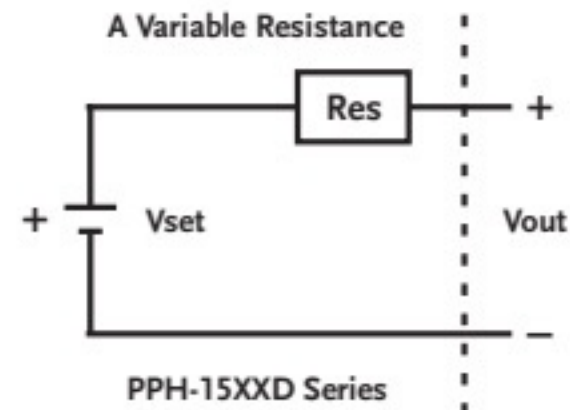

Battery Equivalent Model

PPH-15xxD's battery simulation function is equivalent to a variable resistance circuit internally connected in series to simulate battery's output impedance. The function can also be regarded as a power supply with a variable internal resistor. The variable internal resistance range is from 0.000Ω to 1.000Ω and the resolution is 1mΩ. PPH-15xxD can be utilized as a battery or an ideal voltage source Vset to be connected with variable resistance Res in series. The following diagram shows battery simulation to produce output voltage Vout.

Programmable High-precision D.C. Power Supply



PPX-Series



FEATURES

- * CV, CC Priority Start Function
- * Four Levels of Current Measurement Resolution (min. 0.1μA)/Two Levels of Voltage Measurement Resolution (min. 0.1mV)
- * Power Output ON/OFF Delay Function
- * Adjustable Voltage and Current Slew Rate
- * Bleeder Circuit Control
- * Delayed Over-current Protection(OCP Delay)
- * Sequential Power Output Function
- * Remote Sensing Function & Data Logger
- * 10 Sets of Memory Function
- * Over Voltage Protection, Under Voltage Limit, Over Current Protection, Over Temperature Protection, AC Alarm Function
- * Supports K-Type Thermocouple Temperature Measurement
- * Interfaces: USB, LAN, RS-232, RS-485, Analog Control; Opt: GPIB

The PPX-Series programmable high-precision DC power supplies include six models; PPX-1005(10V/5A/50W), PPX-2002(20V/2A/40W), PPX-2005(20V/5A/100W), PPX-3601(36V/1A/36W), PPX-3603(36V/3A/108W), and PPX-10H01(100V/1A/100W). This series has the output low noise (0.35mVrms) and fast transient response characteristics (<50μs) of conventional linear power supplies. It also provides constant voltage and constant current priority output modes, and the series can also set the voltage and current rising/falling slew rates separately, and the delay time for the output to be turned on and off.

The PPX-Series has four current levels and two voltage levels to provide users with high-precision measurements, and via the Data Logger function, the measurement records can be stored in the USB for long-term measurement and recording of IoT devices, portable devices, wearable devices, and sensor components.

In order to extend the use time of portable devices and wearable devices, manufacturers are not only committed to improving the operating efficiency of the circuit, but also reducing standby power consumption as much as possible. In order to satisfy users' low-power measurement applications, GW Instek has launched the PPX-Series with current measurement resolutions (0.1μA, 1μA, 10μA, 0.1mA) and voltage measurement resolutions (0.1mV, 1mV) to provide power for portable devices and wearable devices. When the device enters the sleep mode or the standby mode, the PPX series can still measure the subtle current changes of the DUT.

The PPX-Series provides the Test Sequence function, which allows users to arbitrarily define output waveforms. The voltage rising or falling time and the voltage maintenance time of each step can be set. For the operation, users can directly edit parameters on the front panel of the PPX-Series, or the CSV file can be edited via computer and imported into the PPX-Series, and the PPX-Series can be remotely edited. In addition, the OCP Delay function of the PPX-Series allows users to flexibly adjust the time to enable the over-current protection according to the characteristics of the DUT to protect the DUT and at the same time to test the current change of the DUT within a certain period of time.

Other than voltage, current, and power measurement, the PPX-Series also supports temperature measurement. While collocating with a K Type Thermocouple, the temperature range can be measured from -200°C ~ +1372°C. Supported standard communication interfaces include USB, LAN, RS-232, RS-485 and optional GPIB interface.



PPX-Series

GTL-205A



GTL-259



GTL-260



GTL-261



GTL-262



SPECIFICATIONS

Model	PPX-1005	PPX-2002	PPX-2005	PPX-3601	PPX-3603	PPX-10H01
DC Output Mode						
Output Voltage	10.000V	20.000V	20.000V	36.000V	36.000V	100.00V
Output Current	5.0000A	2.0000A	5.0000A	1.0000A	3.0000A	1.0000A
Output Power	50W	40W	100W	36W	108W	100W
CONSTANT VOLTAGE OPERATION						
Line Regulation	±(0.01% of setting+1mV)	±(0.01% of setting+1mV)	±(0.01% of setting+1mV)	±(0.01% of setting+3mV)	±(0.01% of setting+3mV)	±(0.01% of setting+7mV)
Load Regulation	±(0.01% of setting+2mV)	±(0.01% of setting+2mV)	±(0.01% of setting+3mV)	±(0.01% of setting+3mV)	±(0.01% of setting+4mV)	±(0.01% of setting+7mV)
Transient Response ¹	<50µs	<50µs	<50µs	<50µs	<50µs	<100µs
Ripple Noise(Vrms ² /Vpp ³)	0.35mVrms/<6mVpp	0.5mVrms/<8mVpp	0.5mVrms/<8mVpp	0.8mVrms/<10mVpp	0.8mVrms/<10mVpp	1.2mVrms/<15mVpp
Rise Time ⁴	Rated load 20ms	50ms	50ms	50ms	50ms	100ms
	No load 20ms	50ms	50ms	50ms	50ms	100ms
Fall Time ⁵	Rated load 10ms	20ms	20ms	20ms	20ms	50ms
	No load 100ms	150ms	150ms	150ms	150ms	250ms
Setting Range (105%)	0V ~ 10.5V	0V ~ 21.0V	0V ~ 21.0V	0V ~ 37.8V	0V ~ 37.8V	0V ~ 105.0V
Setting Resolution	1mV	1mV	1mV	1mV	1mV	10mV
Setting Accuracy (23°C±5°C)	±(0.03% of setting+3mV)	±(0.03% of setting+5mV)	±(0.03% of setting+5mV)	±(0.03% of setting+8mV)	±(0.03% of setting+8mV)	±(0.03% of setting+20mV)
Remote Sensing Compensation Voltage(single line)	1V	1V	1V	1V	1V	3V
Temperature Coefficient (TYP.)	100 ppm/°C	100 ppm/°C	100 ppm/°C	100 ppm/°C	100 ppm/°C	100 ppm/°C
CONSTANT CURRENT OPERATION						
Line Regulation	±(0.02% of setting+250µA)	±(0.02% of setting+100µA)	±(0.02% of setting+250µA)	±(0.02% of setting+50µA)	±(0.02% of setting+150µA)	±(0.02% of setting+50µA)
Load Regulation	±(0.02% of setting+250µA)	±(0.02% of setting+100µA)	±(0.02% of setting+250µA)	±(0.02% of setting+50µA)	±(0.02% of setting+150µA)	±(0.02% of setting+50µA)
Ripple Noise(Arms ²)	2mA	1mA	2mA	400µA	1mA	1mA
Setting Range (105%)	0A ~ 5.25A	0A ~ 2.1A	0A ~ 5.25A	0A ~ 1.05A	0A ~ 3.15A	0A ~ 1.05A
Setting Resolution	0.1mA	0.1mA	0.1mA	0.1mA	0.1mA	0.1mA
Setting Accuracy (23°C±5°C)	±(0.05% of setting+3.0mA)	±(0.05% of setting+1.0mA)	±(0.05% of setting+3.0mA)	±(0.05% of setting+0.5mA)	±(0.05% of setting+1.5mA)	±(0.05% of setting+1.0mA)
Temperature Coefficient (TYP.)	200 ppm/°C	200 ppm/°C	200 ppm/°C	200 ppm/°C	200 ppm/°C	200 ppm/°C
MEASUREMENT AND DISPLAY						
Voltage Range	H 10.000V	20.000V	20.000V	36.000V	36.000V	100.00V
	L 1.0000V	2.0000V	2.0000V	3.6000V	3.6000V	10.000V
Current Range	H 5.0000A	2.0000A	5.0000A	1.0000A	3.0000A	1.0000A
	M 500.00mA	200.00mA	500.00mA	100.00mA	300.00mA	100.00mA
	L 50.000mA	20.000mA	50.000mA	10.000mA	30.000mA	10.000mA
	LL 5.0000mA	2.0000mA	5.0000mA	1.0000mA	3.0000mA	1.0000mA
Measurement Resolution	Voltage(H) 1mV	1mV	1mV	1mV	1mV	10mV
	Voltage(L) 0.1mV	0.1mV	0.1mV	0.1mV	0.1mV	1mV
	Current(H) 0.1mA	0.1mA	0.1mA	0.1mA	0.1mA	0.1mA
	Current(M) 0.01mA	0.01mA	0.01mA	0.01mA	0.01mA	0.01mA
	Current(L) 0.001mA	0.001mA	0.001mA	0.001mA	0.001mA	0.001mA
	Current(LL) 0.0001mA	0.0001mA	0.0001mA	0.0001mA	0.0001mA	0.0001mA
Measurement Accuracy	Voltage(H/L) ±(0.03% of rdg + 2mV)	±(0.03% of rdg + 4mV)	±(0.03% of rdg + 5mV)	±(0.03% of rdg + 6mV)	±(0.03% of rdg + 8mV)	±(0.03% of rdg + 15mV)
	Temperature Coefficient ⁶ (TYP.) 100 ppm/°C	100 ppm/°C	100 ppm/°C	100 ppm/°C	100 ppm/°C	100 ppm/°C
	Current(H/M) ±(0.05% of rdg + 2.5mA)	±(0.05% of rdg + 1.0mA)	±(0.05% of rdg + 2.5mA)	±(0.05% of rdg + 0.4mA)	±(0.05% of rdg + 1.2mA)	±(0.05% of rdg + 1.0mA)
	Current(L/LL) ±(0.1% of rdg + 40µA)	±(0.1% of rdg + 24µA)	±(0.1% of rdg + 40µA)	±(0.1% of rdg + 16µA)	±(0.1% of rdg + 28µA)	±(0.1% of rdg + 24µA)
	Temperature Coefficient ⁶ (TYP.) 200 ppm/°C	200 ppm/°C	200 ppm/°C	200 ppm/°C	200 ppm/°C	200 ppm/°C
TEMPERATURE MEASURED						
Temperature (K-Type Thermocouple)	Range -200°C~+1372°C					
	Resolution 0.25°C					
	Accuracy ±(0.5% + 2°C)					
PROTECTION						
Over Voltage Protection(OVP)	Operation Turns the output off, displays OVP and lights ALARM					
	Setting Range 0.5V ~ 11.0V	1.0V ~ 22.0V	1.0V ~ 22.0V	1.8V ~ 39.6V	1.8V ~ 39.6V	5.0V ~ 110.0V
	(5% to 110% of the rated output voltage)					
	Setting Accuracy ±(1% of rating)					
Over Current Protection(OCP)	Operation Turns the output off, displays OCP and lights ALARM					
	Setting Range 0.25A ~ 5.5A	0.1A ~ 2.2A	0.25A ~ 5.5A	0.05A ~ 1.1A	0.15A ~ 3.3A	0.05A ~ 1.1A
	(5% to 110% of the rated output current)					
	Setting Accuracy ±(1% of rating)					
Over Temperature Protection(OTP)	Operation Turns the output off, displays OTP and lights ALARM					
OTHER						
Interface Capabilities	LAN USB RS-232/RS-485	MAC Address, DNS IP Address, User Password, Gateway IP Address, Instrument IP Address, Subnet Mask				
Nominal Input Voltage ⁷	100Vac / 120Vac / 220Vac / 240Vac(±10%), 50Hz / 60Hz, single phase					
Input Frequency Range	47Hz ~ 63Hz					
Max. Inrush Current	25Amax 200VA	20Amax 150VA	30Amax 300VA	35Amax 150VA	40Amax 300VA	30Amax 300VA
Max. Power Consumption	0°C ~ 40°C					
Operating Temperature	-20°C ~ 70°C					
Storage Temperature	20% ~ 80% RH; No condensation					
Operating Humidity	20% ~ 85% RH; No condensation					
Storage Humidity	107(W) × 124(H) × 313(D) mm (not including protrusions); Approx. 5.5kg					
Dimensions & Weight						

NOTE: *1. Time for output voltage to recover within ±(0.1% + 10mV) of its rated output for a load change from 50% to 100% of its rated output current
 *2. Measurement frequency bandwidth is 5 Hz to 1 MHz
 *3. Measurement frequency bandwidth is 10 Hz to 20 MHz
 *4. From 10%~90% of rated output voltage, with rated resistive load
 *5. From 90%~10% of rated output voltage, with rated resistive load
 *6. Temperature coefficient: after a 30 minute warm-up
 *7. Before connecting the power plug to an AC line outlet, make sure the voltage selector switches of the bottom panel in the correct position. It might be damaged the instrument by connecting to the wrong AC line voltage

Programmable High-precision D.C. Power Supply

Rear Panel



GRA-441-J/E Rack Mount Kit(JIS/EIA)



ORDERING INFORMATION

PPX-1005	10V/5A/50W Programmable High-precision DC Power Supply
PPX-2002	20V/2A/40W Programmable High-precision DC Power Supply
PPX-2005	20V/5A/100W Programmable High-precision DC Power Supply
PPX-3601	36V/1A/36W Programmable High-precision DC Power Supply
PPX-3603	36V/3A/108W Programmable High-precision DC Power Supply
PPX-10H01	100V/1A/100W Programmable High-precision DC Power Supply

ACCESSORIES :

CD (User Manual), Power Cord, Test Lead (GTL-104A for PPX-1005/PPX-2005/PPX-3603, 1m, 10A) (GTL-105A for PPX-2002/PPX-3601, 1m, 3A) (GTL-204A for PPX-1005/PPX-2005/PPX-3603<European Type Jack Terminal>, 1m, 10A) (GTL-203A for PPX-2002/PPX-3601/PPX-10H01<European Type Jack Terminal>, 1m, 3A) (GTL-201A, Ground lead for European Type Jack Terminal)

OPTIONAL ACCESSORIES

GTL-246	USB Cable(USB 2.0 Type A-Type B Cable,4P)
GTL-205A	Temperature probe adapter(thermal coupling, K-Type), about 1000mm
GTL-258	GPIB Cable, 2000mm
GTL-259	RS-232 Cable with DB9 connector to RJ45
GTL-260	RS-485 Cable with DB9 connector to RJ45
GTL-261	Serial Master Cable+Terminator, 0.5M
GTL-262	RS-485 Slave cable
GRA-441-J	Rack for PPX-Series(JIS)
GRA-441-E	Rack for PPX-Series(EIA)
PPX-G	GPIB Interface(factory installed)

A. DISPLAY MODE



Voltage and Current



Voltage, Current and Wattage



Voltage, Current and Sequence Test



Voltage, Current and Temperature Measurement

The PPX-Series has four display modes, namely 1) voltage and current 2) voltage, current and wattage 3) voltage, current and Sequence Test 4) voltage, current and temperature measurement,

which are convenient for users to switch to different display modes according to test requirements.

B. REMOTE SENSING

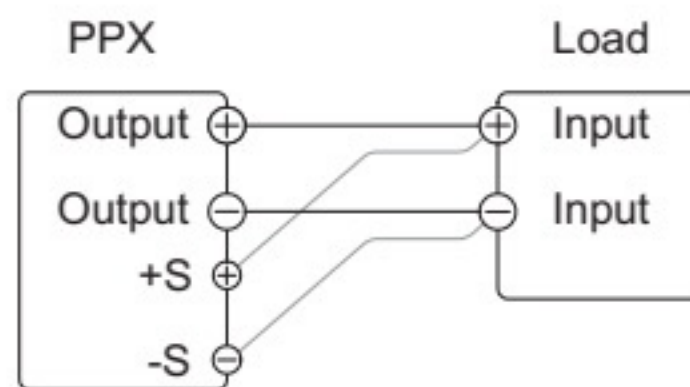

REMOTE SENSING CONNECTION DIAGRAM

The Remote Sensing function can be used to compensate for the voltage drop caused by the resistance on the test connection lead from the power output to the load. PPX-1005/2002/2005/3601/3603 compensates for voltages up to 1 volt, and PPX-10H01 compensates

for voltages up to 3 volts. When testing, choose a test connection lead with a voltage drop less than the compensation voltage of the PPX series as much as possible.

C. TEMPERATURE MEASUREMENT



Blue: Temperature Control on with no GTL-205A Connected



Green: Output Safe is Activated and Output is on with GTL-205A Connected



White: Temperature Control on with GTL-205A Connected



Red: The Alarm of Short Circuit Occurs From Temperature Measurement

The PPX-Series can measure DUT temperature while outputting power. Before measuring the temperature, please use the optional accessory GTL-205A (temperature probe adapter with K-type thermocouple) to connect the DUT and TC input terminals on the front panel of the PPX-Series respectively. During the measurement process, users can set the monitoring

temperature for the DUT. Once the measurement temperature reaches the monitoring temperature value, the PPX-Series will stop the output. The PPX-Series can measure the temperature range of -200.0°C ~ 1372.0°C (-328.0°F ~ 2501.6°F). Users can choose the display unit as $^{\circ}\text{C}$ or $^{\circ}\text{F}$ according to the requirement.

D. DATA LOGGER



Data Logger Function

Dlog Icon Appears

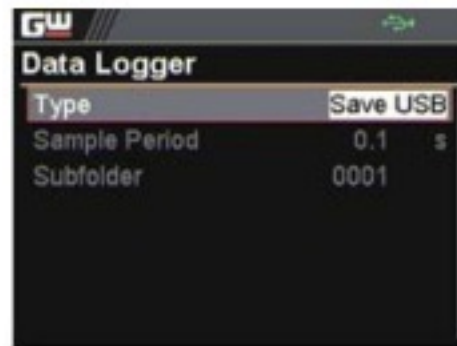

Save Data Log Into USB Disk

The PPX-Series can record the measured voltage, current and temperature data to a USB flash drive or can be remotely controlled to read the data. Data sampling interval is 0.1~999.9 seconds.

E. SEQUENCE TEST

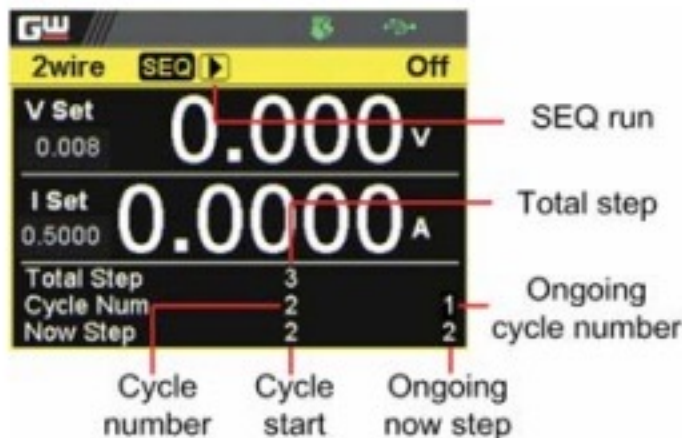

SEQ Run in Cycle Mode

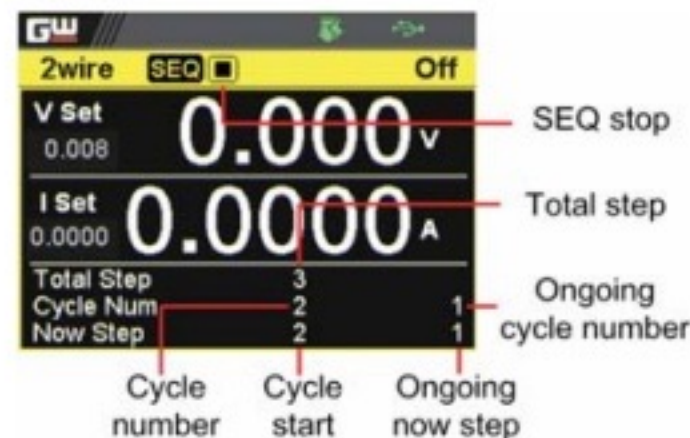

SEQ Stop in Cycle Mode

The Sequence Test function allows users to plan the PPX-Series to execute a sequential power output. The PPX-Series will automatically execute the planned power output to the DUT to realize automated measurement. The PPX-Series can store

Programmable High-precision D.C. Power Supply

F. V/I SLEW RATE

Model	R_V Slew Rate/ F_V Slew Rate Setting Range
PPX-1005	0.0001V/ms ~ 0.1V/ms
PPX-2002	0.0001V/ms ~ 0.2V/ms
PPX-2005	0.0001V/ms ~ 0.2V/ms
PPX-3601	0.0001V/ms ~ 0.36V/ms
PPX-3603	0.0001V/ms ~ 0.36V/ms
PPX-10H01	0.001V/ms ~ 0.5V/ms

Voltage Rising/Falling Slew Rate

The PPX-Series can adjust the slew rate of current and voltage. Via setting the rising and falling time of voltage and current, users can verify the performance of the DUT during the voltage/current changes. In addition, the adjustment of the slew

rate slows down the voltage transfer, which can effectively avoid the damage of the inrush current to the DUT, therefore, the series is especially suitable for the testing of capacitive loads and motors.

G. ANALOG REMOTE CONTROL

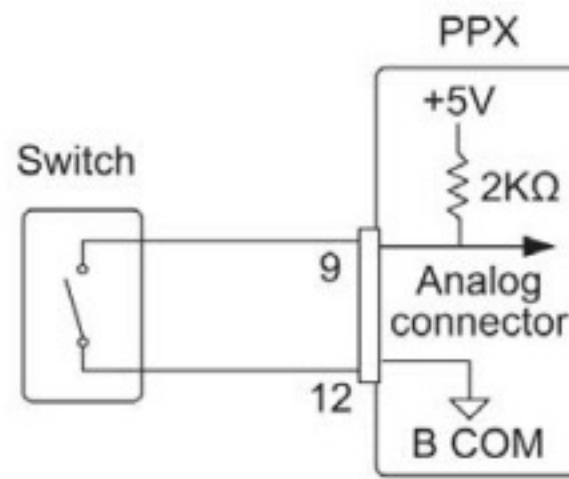

External Control of Output

The PPX-Series supports the analog control function, including external voltage to control voltage output/current output, external resistance to control voltage output/current output, external

control of power output, trigger input/trigger output, and voltage/current monitoring.

H. MULTIPLE UNIT CONNECTION

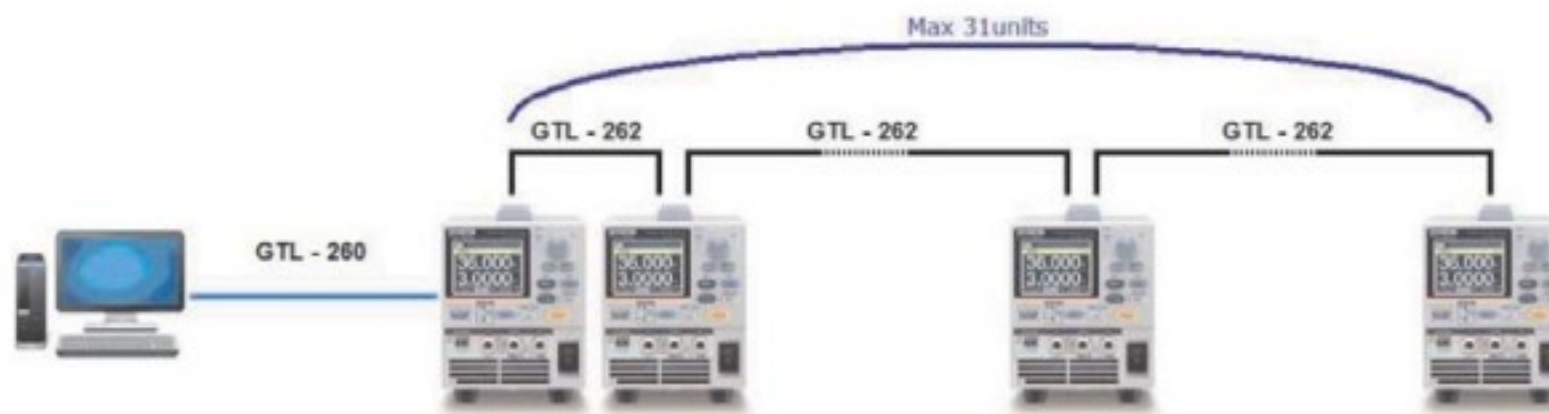

Multiple Unit Connection

The PPX series can connect up to 31 units. The PC is connected to the first unit of PPX through GTL-260, and the remaining PPX units are connected in a daisy-chained method via GTL-262. When using PPX-Series Multiple Unit Connection for remote program

control and slave expansion, there is no need to use other remote control equipment (E.g. switch/Hub), which can help users save equipment purchase costs.

Triple-channel Programmable DC Power Supply



GPP-3060/6030/3650 NEW



FEATURES

- * 4.3" TFT LCD Display
- * Setting Resolution: 1mV/0.1mA;
Read Back Resolution: 0.1mV/0.1mA
- * Low Ripple Noise: $\leq 1\text{mVrms}/\leq 2\text{mArms}$
- * Transient Response Time: $\leq 100\mu\text{s}$
- * Load Function (CC, CV, CR mode)
- * Tracking Series and Parallel Function without Additional External Wiring
- * Utilizing Hardware to Realize Over Voltage Protection/Over Current Protection/Over Temperature Protection
- * Delay Function/Output Monitoring Function/Output Recorder Function
- * Supports Setting Value, Measurement Value and Output Waveform Display
- * Sequential Output Function and Built-in 8 Template Waveforms
- * The Output Recorder Function Records the Output Voltage & Current Parameters with a Minimum Recording Interval of 1 Second
- * Provides 10 Sets of Memory for Each Sequence/Delay/Recorder/Panel Setting Condition
- * GPP-3060/6030 Supports a USB (Type A) Output Terminal
- * Intelligent Temperature Control Fan Effectively Reduces Noise
- * Standard: RS-232, USB, Ext I/O
Optional (manufacturer installed only): LAN, LAN+GPIB

GPP-3060 and GPP-6030 triple-channel programmable DC power supplies are extension models of the GPP-X323 series. The maximum output power of these three models is 385W. GPP-3650 supports CH1/CH2: 0 ~ 36V / 0 ~ 5A output; CH3 supports 1.8V, 2.5V, 3.3V, 5.0V / 5A. GPP-3060 supports CH1/CH2: 0 ~ 30V / 0 ~ 6A output; GPP-6030 supports CH1/CH2: 0 ~ 60V / 0 ~ 3A output; CH3 of both models supports 1.8V, 2.5V, 3.3V, 5.0V/5A.

GPP-3650, GPP-3060 and GPP-6030 inherit the high program resolution (1mV/0.1mA) and read back resolution (0.1mV/0.1mA) of the GPP series with low-ripple noise characteristics $\leq 1\text{mVrms}/\leq 2\text{mArms}$ and $\leq 100\mu\text{s}$ output transient recovery ability. An independent output on-off switch is provided for each channel.

For series and parallel applications of CH1 and CH2, the tracking function can automatically switch to series or parallel output without additional external wiring. Multiple display modes including single channel or multi-channel setting value, measurement value and waveform display to collocate with the built-in output monitoring function allow users to set the monitoring conditions according to their needs so as to generate an alarm or stop the output during the measurement process in order to stop the measurement and protect the customer's DUT. The output recorder function can record the voltage/current of the output process in the internal memory, and save the result as a (*.REC) or (*.CSV) file, and then save it to a USB flash drive. The unique load function of the GPP series can arbitrarily set CH1/CH2 as power supply or load function. For example, one channel is set as power output, and the other channel is set as load function to consume the power of the DUT to satisfy simple battery charging and discharging or load characteristic test by a single power supply. The sequence output function allows users to edit the power output waveforms by themselves, and also allows users to set the sequential constant voltage (CV) or constant current (CC) load waveforms such as serial power output or dynamic load simulation test. Channel 3 (CH3) incorporates 3A USB (Type A) output terminal, which can be used for USB charging test.

Pertaining to measurement protections, OVP/OCP/OPP/OTP protection functions are provided. The protection mechanism of OVP/OCP/OTP is implemented by hardware circuits, which has a faster response time to protect equipment or DUT while comparing with competitors who use software for protection. The OVP and OCP functions allow users to set the protection action point according to the conditions of the DUT. OPP only provides protection during the operation of the load function.

In addition, GPP-3650, GPP-3060 and GPP-6030 incorporate terminal output on the rear panel, and include a voltage remote sensing terminal. Users can choose front panel or rear panel terminal output, which is convenient for stand-alone or rack operation. Output value setting and Sequence/ The Delay/Recorder functions provide 10 sets of internal memory, which can be uploaded/stored by a USB flash drive.



GPP-3650

GRA-449-J Rack Mount Kit (JIS)



GRA-449-E Rack Mount Kit (EIA)



Rear Panel



European Type Jack Terminal



Triple-channel Programmable DC Power Supply

SPECIFICATIONS

		GPP-3060			GPP-6030			GPP-3650		
Output Mode										
Number of Channel		CH1	CH2	CH3	CH1	CH2	CH3	CH1	CH2	CH3
Voltage		0 ~ 30.000V	0 ~ 30.000V	1.8V/2.5V/3.3V/5.0V,±5%	0 ~ 60.000V	0 ~ 60.000V	1.8V/2.5V/3.3V/5.0V,±5%	0 ~ 36.000V	0 ~ 36.000V	1.8V/2.5V/3.3V/5.0V,±5%
Current		0 ~ 6.0000A	0 ~ 6.0000A	5A (USB Port 3A)	0 ~ 3.0000A	0 ~ 3.0000A	5A (USB Port 3A)	0 ~ 5.0000A	0 ~ 5.0000A	5A (USB Port 3A)
Tracking Series Voltage / Current		0 ~ 60.000V / 0 ~ 6.0000A	-	-	0 ~ 120.000V / 0 ~ 3.0000A	-	-	0 ~ 72.000V / 0 ~ 5.0000A	-	-
Tracking Parallel Voltage / Current		0 ~ 30.000V / 0 ~ 12.0000A	-	-	0 ~ 60.000V / 0 ~ 6.0000A	-	-	0 ~ 36.000V / 0 ~ 10.0000A	-	-
Warning	The CH3 output current from the 2 terminals should Not exceed 5A.									
Constant Voltage Operation										
Line Regulation		≤ 0.01% + 3mV	≤ 3mV	-	≤ 0.01% + 3mV	≤ 3mV	-	≤ 0.01% + 3mV	≤ 3mV	-
Load regulation		≤ 0.01% + 5mV (rating current ≤ 10A)	≤ 5mV	-	≤ 0.01% + 5mV (rating current ≤ 10A)	≤ 5mV	-	≤ 0.01% + 5mV (rating current ≤ 10A)	≤ 5mV	-
Ripple & noise (5Hz-1MHz)		≤ 1mVrms	≤ 2mVrms	-	≤ 1mVrms	≤ 2mVrms	-	≤ 1mVrms	≤ 2mVrms	-
Transient recovery time		≤ 100µs (50% load change - minimum load 0.5A)								
Temperature coefficient		≤ 300ppm/°C								
Constant Current Operation										
Line Regulation		≤ 0.01% + 3mA								
Load regulation		≤ 0.01% + 3mA								
Ripple & noise		≤ 2mArms								
Resolution										
Programming	Voltage	1mV			2mV			2mV		
	Current	0.2mA			0.1mA			0.1mA		
Reedback	Voltage	0.1mV			0.1mV			0.1mV		
	Current	0.1mA			0.1mA			0.1mA		
Tracking Operation(CH1/CH2)										
Tracking error		≤ 0.1% + 10mV of Master (No Load, with load add load regulation ≤ 200mV)			≤ 0.2% + 20mV of Master (No Load, with load add load regulation ≤ 200mV)			≤ 0.1% + 10mV of Master (No Load, with load add load regulation ≤ 200mV)		
Parallel regulation	Line	≤ 0.01% + 3mV			≤ 0.01% + 3mV			≤ 0.01% + 3mV		
	Load	≤ 0.01% + 5mV (rating current ≤ 10A) ≤ 0.02% + 5mV (rating current > 10A)			≤ 0.01% + 5mV (rating current ≤ 10A) ≤ 0.02% + 5mV (rating current > 10A)			≤ 0.01% + 5mV (rating current ≤ 10A) ≤ 0.02% + 5mV (rating current > 10A)		
Series regulation	Line	≤ 0.01% + 5mV			≤ 0.01% + 5mV			≤ 0.01% + 5mV		
	Load	≤ 200mV			≤ 200mV			≤ 200mV		
Ripple & noise		≤ 2mVrms(5Hz-1MHz)			≤ 2mVrms(5Hz-1MHz)			≤ 2mVrms(5Hz-1MHz)		
Note	Tracking is not supported in LOAD mode.									
Meter										
Full Scale	Voltage	32.0000V	1.8V/2.5V/3.3V/5.0V		62.0000V	1.8V/2.5V/3.3V/5.0V		36.0000V	1.8V/2.5V/3.3V/5.0V	
	Current	6.2000A	-		3.2000A	-		5.2000A	-	
Programming	Voltage	5 digits	-		5 digits	-		5 digits	-	
	Current	5 digits	-		5 digits	-		5 digits	-	
Reedback	Voltage	6 digits	-		6 digits	-		6 digits	-	
	Current	5 digits	-		5 digits	-		5 digits	-	
Setting accuracy	Voltage	± (0.03% of reading + 10mV)			± (0.03% of reading + 10mV)			± (0.03% of reading + 10mV)		
	Current	± (0.3% of reading + 10mA)			± (0.3% of reading + 10mA)			± (0.3% of reading + 10mA)		
Reedback accuracy	Voltage	± (0.03% of reading + 10mV)			± (0.03% of reading + 10mV)			± (0.03% of reading + 10mV)		
	Current	± (0.3% of reading + 10mA)			± (0.3% of reading + 10mA)			± (0.3% of reading + 10mA)		
DC Load Mode										
Display	Voltage	1 ~ 32.00V			1 ~ 62.00V			1 ~ 36.5.00V		
	Current	0 ~ 6.200A			0 ~ 3.200A			0 ~ 5.200A		
	Power	0 ~ 50.00W			0 ~ 50.00W			0 ~ 50.00W		
CV Mode	CH1/CH2	1.500V ~ 32.00V			1.500V ~ 62.00V			1.500V ~ 36.50V		
	Setting Accuracy	≤ ±(0.1% + 30mV)			≤ ±(0.1% + 30mV)			≤ ±(0.1% + 30mV)		
	Reedback Accuracy	≤ ±(0.1% + 30mV)			≤ ±(0.1% + 30mV)			≤ ±(0.1% + 30mV)		
	Resolution	10mV			10mV			10mV		
CC Mode	CH1/CH2	0 ~ 6.200A			0 ~ 3.200A			0 ~ 5.200A		
	Setting Accuracy	≤ ±(0.3% + 10mA)			≤ ±(0.3% + 10mA)			≤ ±(0.3% + 10mA)		
	Reedback Accuracy	≤ ±(0.3% + 10mA)			≤ ±(0.3% + 10mA)			≤ ±(0.3% + 10mA)		
	Resolution	1mA			1mA			1mA		
CR Mode	CH1/CH2	1Ω ~ 1kΩ			1Ω ~ 1kΩ			1Ω ~ 1kΩ		
	Setting Accuracy	≤ ±(3% + 1Ω) (voltage ≥ 0.1V, and current ≥ 0.1A)			≤ ±(3% + 1Ω) (voltage ≥ 0.1V, and current ≥ 0.1A)			≤ ±(3% + 1Ω) (voltage ≥ 0.1V, and current ≥ 0.1A)		
	Reedback Accuracy	≤ ±(3% + 1Ω) (voltage ≥ 0.1V, and current ≥ 0.1A)			≤ ±(3% + 1Ω) (voltage ≥ 0.1V, and current ≥ 0.1A)			≤ ±(3% + 1Ω) (voltage ≥ 0.1V, and current ≥ 0.1A)		
	Resolution	1Ω			1Ω			1Ω		
Protection										
OVP	Power Mode	OFF,ON(0.5V-35.0V)		Fixed 5.5V	OFF,ON(0.5V-65.0V)		Fixed 5.5V	OFF,ON(0.5V-38.0V)		Fixed 5.5V
	Load Mode	OFF,ON(1.5V-35.0V)		-	OFF,ON(1.5V-65.0V)		-	OFF,ON(1.5V-38.0V)		-
	Setting Accuracy	-		-	±100mV		-	±100mV		-
OCP	Power Mode	OFF,ON(0.05A-6.50A)		3.1A(USB port)	OFF,ON(0.05A-3.50A)		3.1A(USB port)	OFF,ON(0.05A-5.50A)		3.1A(USB port)
	Load Mode	OFF,ON(0.05A-6.50A)		-	OFF,ON(0.05A-3.50A)		-	OFF,ON(0.05A-5.50A)		-
	Setting Accuracy	-		-	±20mA		-	±20mA		-
Insulation resistance	Between chassis and terminal	20MΩ or above (DC 500V)								
	Between chassis and DC power cord	30MΩ or above (DC 500V)								
General										
Operation Environment	Indoor use, Altitude: ≤ 2000m									
	Ambient temperature: 0 ~ 40°C									
	Relative humidity: ≤ 80%									
Storage Environment	Installation category: II / Pollution degree: 2									
	TEMPERATURE: -10°C ~ 70°C									
Power Input	HUMIDITY: ≤ 70%									
Power Consumption	AC 100V/120V/220V/230V±10%, 50/60Hz									
Accessories	900VA, 680W									
	CD User manual x1, Quick Start manual x1, Power Code x1									
	Test lead: GTL-104A x 3									
Dimensions	(Europe) Test lead: GTL-204A x 3, GTL-201A x 1									
	213 (W) x 145 (H) x 362 (D) mm									
Weight	Approx. 10kg									

ORDERING INFORMATION

GPP-3060 385W Triple-channel Programmable DC Power Supply

GPP-3650 385W Triple-channel Programmable DC Power Supply

GPP-6030 385W Triple-channel Programmable DC Power Supply

ACCESSORIES :

CD (User manual), Quick start manual, Power cord, test lead: GTL-104A x 3, European test leads: GTL-204A x 3, GTL-201A x 1

OPTIONAL ACCESSORIES

GTL-246 USB Cable

GRA-449-E Rack Mount Kit (EIA)

GRA-449-J Rack Mount Kit (JIS)

INTERFACE

Standard: RS-232, USB, Ext I/O, Optional(manufacturer installed only): LAN, GPIB+LAN

NOTE: Contact local sales if you have issues with Interface purchase.

A. TRACKING SERIES AND PARALLEL FUNCTION

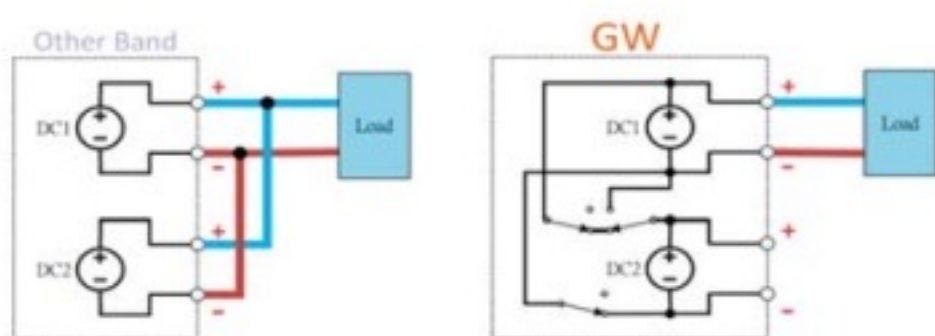

Output in Parallel Connections

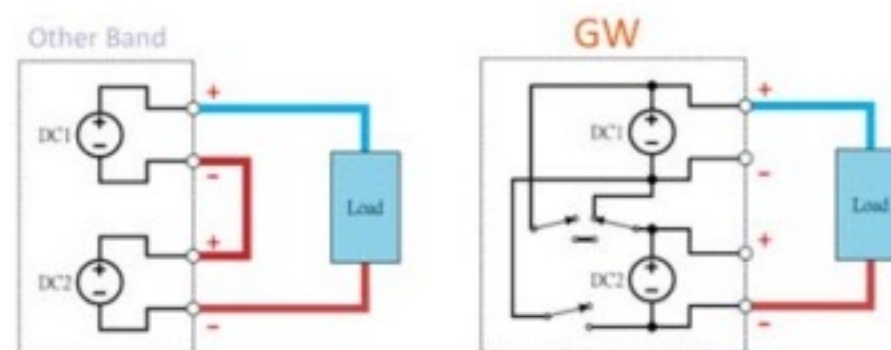

Output in Series Connections

For series and parallel applications of CH1 and CH2, the tracking function of the GPP-Series utilizes the internal circuit to automatically switch the output to serial or parallel output without additional external wiring, providing users with convenience not only in operating procedures but also a more stable output.

The tracking function design of other brands requires additional external wiring connections for the output in series or parallel. However, excessively long, thin or inconsistent external wiring may cause inaccurate voltage or current output.

B. OUTPUT MONITORING FUNCTION

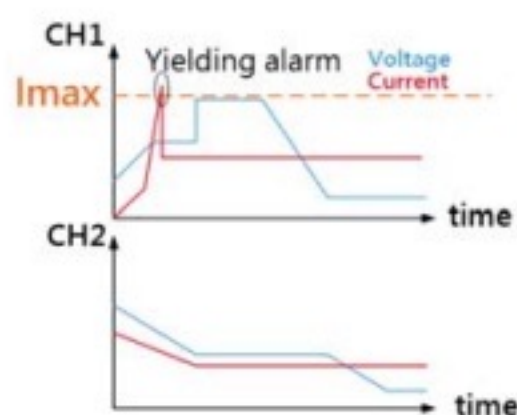

Output Monitoring



Monitoring Function Setting

The output monitoring function allows users to set the monitoring conditions according to the requirements, including the voltage, current, and power greater than or less than the setting and the logical relationship of AND, OR. It also allows users to sound

alarms or stop the output during the measurement process, stop the measurement, and protect the customer's DUT. Both Channel could be monitored simultaneously as well.

* Channel 3 does not support the output monitoring function.

C. SEQUENCE OUTPUT FUNCTION



Output Waveform of the GPP-6030/3060

The GPP-Series provides a sequential output function on Channel 1 and Channel 2. This function not only allows users to edit the power output waveform, but also allows users to set the sequential constant voltage (CV) or constant current (CC) load waveform, i.e. a serial power output or a simulation test of a dynamic load. The maximum settable points for sequence function are 2048, and interval range of each point can be set from 1 to 300 seconds. In order to simplify the setting of waveform editing, the GPP-Series has 8 built-in Templet waveforms in sequence output function for

users to directly apply for output, including Sine, Pulse, Ramp, Stair Up, Stair Dn, Stair UpDn, Exp Rise, and Exp Fall waveforms.

The editing data of the sequence output can be stored in the internal 10 sets of the memory, or to be saved by USB flash drive (Save/Recall) and saved as *.SEQ or *.CSV file; The stored *.CSV can be exported into Excel for editing and analysis. The final edited file can be imported to (Save/Recall) of the power supply using a USB flash drive.

Triple-channel Programmable DC Power Supply

D. HARDWARE PROTECTION FUNCTION(OVP/OCP/OTP)

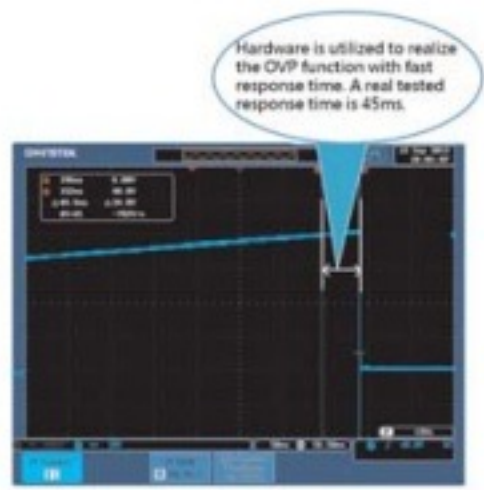

OVP Trigger

The protection mechanism of OVP/OCP/OTP is implemented by hardware circuit, which has the advantage of faster response time than competitors who use software to achieve protection. When it is detected that the voltage of the DUT exceeds the setting value of the OVP, the output of the power supply can be stopped in a short time to achieve the purpose of protecting the DUT.

E. LOAD FUNCTION

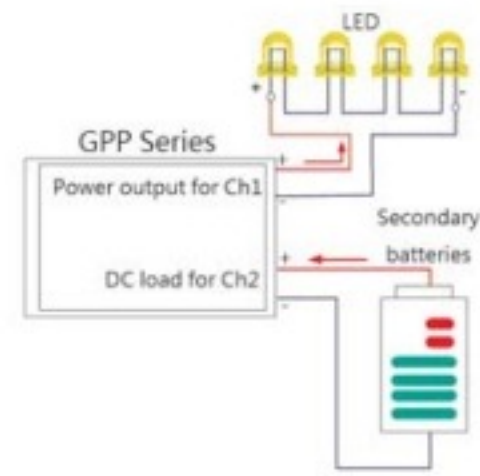

GPP-Series Application

The CH1/CH2 of the GPP series is designed with the load function. A single power supply can meet the basic battery charging and discharging test requirements. It can provide power output in channel 1 and channel 2. The rated constant voltage load (CV), rated constant current load (CC) and maximum 1kΩ constant resistance load (CR) function are built-in to allow users to conduct discharging test without using an electronic load. In application, users can also set either that one channel of the single GPP series as the power output, one channel as the load function to consume the power of the DUT, or that both channels as load functions to consume the power of different loads simultaneously.

F. OUTPUT DELAY FUNCTION



GPP-Series Delayed Waveform

Output delay function allows users to edit the timing waveform of the power output on/off when the front panel voltage and current settings are unchanged. In order to simplify the setting of waveform editing, the GPP-Series has three built-in timing modes in the delay output function, including Fixtime, Increase, Decline for users to apply directly. The editing data of the output delay can be stored in

the internal 10 sets of memory, or to be saved by USB flash drive (Save/Recall) and saved as *.DLY or *.CSV file. The stored *.CSV can be exported into Excel for editing and analysis. The final edited file can be exported to (Save/Recall) of the power supply using a USB flash drive.

G. OUTPUT RECORDER FUNCTION

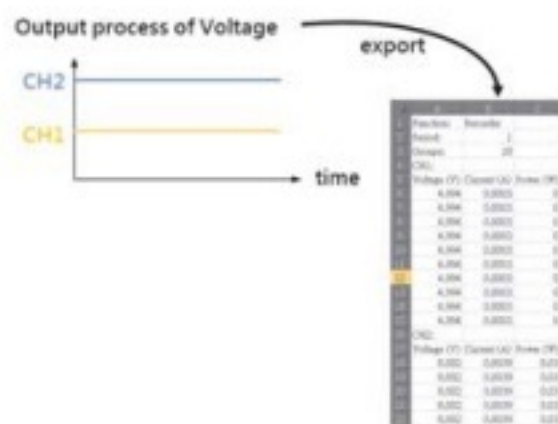

Schematic Diagram for Recorder Function

The output recorder function records the voltage & current parameters of the output process. The recording interval of each point can be set according to user's requirements, and the shortest interval is 1 second and the longest is 300 seconds. The results can be stored in *.REC or *.CSV format to the power supply or directly



Recorder Function Setting



Save as *.REC

saved in the USB flash drive. The stored *.CSV can be exported into Excel to conduct the future analysis. (*.REC can be saved to 2048 records, *.CSV can be saved to 614400 records)

* Channel 3 does not support the output recorder function

Multi-output Programmable D.C. Power Supply



GPP-Series



FEATURES

- ✦ 4.3" TFT LCD Display
- ✦ Supports Setting Value, Measurement Value and Output Waveform Display
- ✦ Load Function (CC, CV, CR Mode)
- ✦ Setting Resolution: 1mV/0.1mA ; Read Back Resolution: 0.1mV/0.1mA
- ✦ Low Ripple Noise: $\leq 350\mu\text{Vrms}/\leq 2\text{mArms}$
- ✦ Transient Response Time: $\leq 50\mu\text{s}$
- ✦ Tracking Series and Parallel Function without Additional External Wiring
- ✦ Utilizing Hardware to Realize Over Voltage Protection/Over Current Protection/Over Temperature Protection
- ✦ Delay Function/Output Monitoring Function/Output Recorder Function
- ✦ Intelligent Temperature Control Fan Effectively Reduces Noise
- ✦ Sequential Output Function and Built-in 8 Template Waveforms
- ✦ The Output Recorder Function Records The Output Voltage & Current Parameters with A Minimum Recording Interval of 1 Second
- ✦ Provides 10 Sets of Memory for Each Sequence /Delay/Recorder/Panel Setting Condition
- ✦ GPP-3323 Supports A USB(Type A) Output Terminal
- ✦ Standard: RS-232, USB, Ext I/O; Optional (Manufacturer Installed Only) : LAN, GPIB+LAN
- ✦ Compatible with Commands of GPD-X303S Series

With the maximum output power of 217W, the GPP-Series, the multi-channel programmable DC power supply, includes four models: GPP-1326 (0–32V/0–6A) for single-channel output and GPP-2323 for dual-channel output (CH1:0–32V/0–3A, CH2:0–32V/0–3A), GPP-3323 for three-channel output (CH1: 0–32V/0–3A, CH2:0–32V/0–3A, CH3: 1.8V, 2.5V, 3.3V, 5.0V/5A) and GPP-4323 for four-channel output (CH1:0–32V/0–3A, CH2:0–32V/0–3A, CH3:0–5V/0–1A, CH4: 0–15V/0–1A). This series not only provides high program resolution (1mV/0.1mA) and read back resolution (0.1mV/0.1mA), but also features optimal low-ripple noise characteristics $\leq 350\mu\text{Vrms}/\leq 2\text{mArms}$ and output transient recovery capability $\leq 50\mu\text{s}$. Independent output on-off switch is provided for each channel.

For series and parallel applications of CH1 and CH2, the tracking function of the GPP-Series utilizes the internal circuit to automatically switch the output to serial or parallel output without additional external wiring, providing users with convenience not only in operating procedures but also a more stable output. The tracking function design of other brands requires additional external wiring connections for the output in series or parallel. However, excessively long, thin or inconsistent external wiring may cause inaccurate voltage or current output.

The GPP-Series offers a variety of display modes, including single or multi-channel setting values, measurement values, and waveform displays. The Monitor function of the GPP-Series allows users to set monitoring conditions according to requirements, sound alarms or stop output during the measurement process, and stop measurement and protect the customer's DUT. The GPP-Series provides output recorder function, which records the voltage/current of the output process to the internal memory, and the result can be stored as a (*.REC) or (*.CSV) file, which can then be transferred to the USB flash drive. The stored *.CSV can be exported to the Excel to conduct the future analysis.

The CH1/CH2 of the GPP-Series are designed with the load function. A single power supply can set one channel as the power output, and one channel for the load function to consume the power of the DUT so as to meet the basic charging and discharging test requirements for battery. Channel 1 and channel 2 not only provide 32V/3A power output, but also feature built-in maximum 32V constant voltage load (CV), maximum 3.2A constant current load (CC) and maximum 1k Ω constant resistance load (CR) function.

The GPP-Series provides the sequential output function on Channel 1 and Channel 2. This function not only allows users to edit the power output waveform, but also allows users to set the sequential constant voltage (CV) or constant current (CC) load waveform, i.e. a serial power output or a simulation test of a dynamic load. In order to simplify the setting of waveform editing, the GPP-Series has 8 built-in Template waveforms in the sequence output function for users to directly apply for output, including Sine, Pulse, Ramp, Stair Up, Stair Dn, Stair UpDn, Exp Rise, Exp Fall waveforms.

The sound protection functions include OVP/OCP/OPP/OTP, in which the protection mechanism for OVP/OCP/OTP is implemented by hardware circuit that has the advantage of faster response time compared with competitors who adopt software to achieve protections. The OVP/OCP functions allow users to set the protection action point (except CH3 of GPP-3323) according to the conditions of the DUT. The OPP is only activated during the operation of the load function. The Delay Function sets the length of time during channel 1 or channel 2 power output on or during power output off.

In addition, the Trigger In/Trigger Out functions synchronize external devices. The GPP-3323 channel 3 adds a 3A USB (Type A) output terminal for USB charging test. The intelligent temperature-controlled fan can adjust the speed according to the temperature of the power transistor so as to reduce unnecessary noise. The output value setting and the Sequence/Delay/Recorder functions provide 10 sets of internal memory for use, and can be loaded/stored using a USB flash drive. In addition to the standard RS-232 and USB remote interfaces, the GPP-Series also has an optional LAN or LAN+GPIB interface to facilitate different requirements. The commands of the GPP-Series conform to SCPI requirements and are compatible with the commands of the GPD-X303S Series.

European Type Jack Terminal



Rear Panel (LAN+GPIB)



Rear Panel (LAN)



Rear Panel



OUTPUT FUNCTION LIST

Model Number	GPP-4323			
	GPP-3323			
	GPP-2323			
	GPP-1326			
Number of Outputs	CH1	CH2	CH3	CH4
Sequence Output Function	✓	✓		
Load Functions (CC, CV, CR mode)	✓	✓		
Output Delay Function	✓	✓		
Output Monitoring Monitor(10 sets)	✓	✓	(GPIB not supported)	✓
Output Recorder Function	✓	✓	(GPIB not supported)	✓
Panel Save/Recall	✓	✓	✓	✓

Multi-output Programmable D.C. Power Supply

SPECIFICATIONS

		GPP-1326	GPP-2323	GPP-3323	GPP-4323
OUTPUT MODE					
Number of Channel		CH1	CH1, CH2	CH1, CH2	CH1, CH2, CH3, CH4
Voltage		0 - 32.000V	0 - 32.000V	0 - 32.000V	1.8V/2.5V/3.3V/5.0V, ±5%
Current		0 - 6.0000A	0 - 3.0000A	0 - 3.0000A	5A (USB Port 3A)
Tracking Series Voltage/Current		-	0 - 64.000V / 0 - 3.0000A	0 - 64.000V / 0 - 3.0000A	0 - 64.000V / 0 - 3.0000A
Tracking Parallel Voltage/Current		-	0 - 32.000V / 0 - 6.0000A	0 - 32.000V / 0 - 6.0000A	0 - 32.000V / 0 - 6.0000A
Warning: The CH3 of GPP-3323 output current from the 2 terminals should Not exceed 5A.					
CONSTANT VOLTAGE OPERATION					
Line Regulation		≤ 0.01% + 3mV	≤ 0.01% + 3mV	≤ 0.01% + 3mV	≤ 3mV
Load Regulation		≤ 0.01%+3mV(rating current≤3A) ≤ 0.02%+5mV(rating current>3A)	≤ 0.01%+3mV(rating current≤3A) ≤ 0.02%+5mV(rating current>3A)	≤ 0.01%+3mV(rating current≤3A) ≤ 0.02%+5mV(rating current>3A)	≤ 0.01%+3mV(rating current≤3A) ≤ 0.02%+5mV(rating current>3A)
Ripple & Noise (5Hz-1MHz)		≤0.5mVrms	≤0.35mVrms	≤0.35mVrms	≤2mVrms
Transient Recovery Time		≤100µs	≤50µs	≤50µs	≤100µs
Temperature Coefficient		≤ 300ppm/°C (50% load change · minimum load 0.5A)			
CONSTANT CURRENT OPERATION					
Line Regulation		≤ 0.2% + 3mA			
Load Regulation		≤ 0.2% + 3mA			
Ripple & Noise		≤4mArms	≤2mArms	≤2mArms	≤2mArms
Resolution					
Programming	Voltage/Current	1mV / 0.2mA	1mV / 0.1mA	1mV / 0.1mA	1mV / 0.1mA
Reedback	Voltage/Current	1mV / 0.2mA	0.1mV / 0.1mA	0.1mV / 0.1mA	0.1mV / 0.1mA
TRACKING OPERATION(CH1/CH2)					
Tracking Error		≤±(0.1%+10mV of Master(0-32V)) (No Load, with load add load regulation≤100mV)		≤±(0.1%+10mV of Master(0-32V)) (No Load, with load add load regulation≤100mV)	
Parallel Regulation	Line	≤ 0.01% + 3mV		≤ 0.01% + 3mV	
	Load	≤ 0.01%+3mV(rating current≤3A) ≤ 0.02%+5mV(rating current>3A)		≤ 0.01%+3mV(rating current≤3A) ≤ 0.02%+5mV(rating current>3A)	
Series Regulation	Line	≤ 0.01% + 5mV		≤ 0.01% + 5mV	
	Load	≤ 100mV		≤ 100mV	
Ripple & Noise		≤1mVrms(5Hz-1MHz)		≤1mVrms(5Hz-1MHz)	
Note: GPP-1326 does not have Tracking function,and Tracking is not supported in LOAD mode.					
METER					
Full Scale	Voltage/Current	33.0000V / 6.2000A	33.0000V / 3.2000A	33.0000V / 3.2000A	1.8V/2.5V/3.3V/5.0V
Programming Resolution	Voltage/Current	5 digits / 5 digits	5 digits / 5 digits	5 digits / 5 digits	5 digits / 5 digits
Reedback Resolution	Voltage/Current	6 digits / 5 digits	6 digits / 5 digits	6 digits / 5 digits	5 digits / 6 digits
Setting Accuracy	Voltage	± (0.03% of reading + 10mV)	± (0.03% of reading + 10mV)	± (0.03% of reading + 10mV)	± (0.03% of reading + 10mV)
	Current	± (0.3% of reading + 10mA)	± (0.3% of reading + 10mA)	± (0.3% of reading + 10mA)	± (0.3% of reading + 10mA)
Reedback Accuracy	Voltage	± (0.03% of reading + 10mV)	± (0.03% of reading + 10mV)	± (0.03% of reading + 10mV)	± (0.03% of reading + 10mV)
	Current	± (0.3% of reading + 10mA)	± (0.3% of reading + 10mA)	± (0.3% of reading + 10mA)	± (0.3% of reading + 10mA)
DC LOAD MODE					
Display	Voltage	1 - 33.00V	1 - 33.00V	1 - 33.00V	1 - 33.00V
	Current	0 - 6.200A	0 - 3.200A	0 - 3.200A	0 - 3.200A
	Power	0 - 100.00W	0 - 50.00W	0 - 50.00W	0 - 50.00W
CV Mode	CH1/CH2	1.500V - 33.00V	1.500V - 33.00V	1.500V - 33.00V	1.500V - 33.00V
	Setting/Reedback Accuracy	≤±(0.1% + 30mV)	≤±(0.1% + 30mV)	≤±(0.1% + 30mV)	≤±(0.1% + 30mV)
	Resolution	10mV	10mV	10mV	10mV
CC Mode	CH1/CH2	0 - 3.200A	0 - 3.200A	0 - 3.200A	0 - 3.200A
	Setting/Reedback Accuracy	≤±(0.3% + 10mA)	≤±(0.3% + 10mA)	≤±(0.3% + 10mA)	≤±(0.3% + 10mA)
	Resolution	1mA	1mA	1mA	1mA
CR Mode	CH1/CH2	10- 1kΩ	10- 1kΩ	10- 1kΩ	10- 1kΩ
	Setting/Reedback Accuracy	≤±(3% + 1Ω)	≤±(3% + 1Ω)	≤±(3% + 1Ω)	≤±(3% + 1Ω)
	Resolution	1Ω	1Ω	1Ω	1Ω
PROTECTION					
OVP	Power Mode	OFF,ON(0.5V - 35.0V)	OFF,ON(0.5V - 35.0V)	OFF,ON(0.5V - 35.0V)	Fixed 5.5V
	Load Mode	OFF,ON(1.5V - 35.0V)	OFF,ON(1.5V - 35.0V)	OFF,ON(1.5V - 35.0V)	-
	Setting Accuracy	±100mV	±100mV	±100mV	±100mV
	Resolution	100mV	100mV	100mV	100mV
OCP	Power Mode	OFF,ON(0.05A - 7.00A)	OFF,ON(0.05A - 3.50A)	OFF,ON(0.05A - 3.50A)	3.1A(USB port)
	Load Mode	OFF,ON(0.05A - 7.00A)	OFF,ON(0.05A - 3.50A)	OFF,ON(0.05A - 3.50A)	-
	Setting Accuracy	±20mA	±20mA	±20mA	±20mA
	Resolution	10mA	10mA	10mA	10mA
Insulation Resistance		Between chassis and terminal : 20MΩ or above (DC 500V) Between chassis and DC power cord : 30MΩ or above (DC 500V)			
GENERAL					
Operation Environment		Indoor use, Altitude: ≤ 2000m ; Ambient temperature: 0 - 40°C / Relative humidity: ≤ 80% ; Installation category: II / Pollution degree: 2			
Storage Environment		TEMPERATURE: -10°C - 70°C / HUMIDITY: ≤70%			
Power Input		AC 100V/120V/220V/230V±10%, 50/60Hz			
Power Consumption		360W	360W	420W	420W
Dimensions & Weight		213 (W) x 145 (H) x 312 (D) mm ; Approx. 7.5kg			

ORDERING INFORMATION

- GPP-1326** (32V/6A) Single-Output Programmable DC Power Supply
GPP-2323 (32V/3A*2) Dual-Output Programmable DC Power Supply
GPP-3323 (32V/3A*2; 1.8V or 2.5V or 3.3V or 5V/5A*1) Three-Output Programmable DC Power Supply
GPP-4323 (32V/3A*2; 5V/1A; 15V/1A) Four-Output Programmable DC Power Supply

ACCESSORIES :

User Manual x 1 , Power cord x 1

European Test Leads :

- GPP-1326** Test Lead GTL-104A x 1, GTL-105A x 1 **GPP-2323** Test Lead GTL-104A x 2 **GPP-1326** GTL-203A x 1, GTL-204A x 1, GTL-201A x 1 **GPP-2323** GTL-204A x 2, GTL-201A x 1
GPP-4323 Test Lead GTL-104A x 2, GTL-105A x 2 **GPP-3323** Test Lead GTL-104A x 3 **GPP-4323** GTL-203A x 2, GTL-204A x 2, GTL-201A x 1 **GPP-3323** GTL-204A x 3, GTL-201A x 1

OPTIONAL ACCESSORIES

GTL-246 USB Cable **GRA-449-J** Rack Mount Kit (JIS) **GRA-449-E** Rack Mount Kit (EIA)

OPTIONS (Manufacturer Installed Only)

LAN Interface; GPIB+LAN Interface

Multiple Output Programmable Linear D.C. Power Supply



GPD-2303S/3303S/ 4303S/3303D



FEATURES

- * 2, 3 and 4 Independent Isolated Output
- * 4 LED Display Sets : 3 Digits After Decimal Point (GPD-2303S/3303S/4303S)
- * Minimum Resolution :
GPD-2303S/3303S/4303S (1mV/1mA)
GPD-3303D (100mV/10mA)
- * Digital Panel Control (Rotary Encoder Switch, Rubber Key With Indicator)
- * User-Friendly Operation, Coarse / Fine Volume Control
- * 4 Sets Save / Recall
- * Key-Lock
- * Output ON/OFF
- * Tracking Series and Parallel Mode
- * Smart Cooling Fan Achieving Low Noise
- * Compact Design
- * PC Software & USB Driver
- * USB Standard Interface
- * Optional European Jack Type Terminal

Rear Panel



European Type Jack Terminal



The GPD-Series is a cutting edge, economical, high resolution programmable power supply, Which is equipped with 2, 3 and 4 independent output channels and support a maximum output from 180Watt to 195Watt. The power supplies include four sets of memory for voltage and current setting, a USB remote interface, high resolution (GPD-2303S / GPD-3303S / GPD-4303S) and intelligent fan control to reduce noise. The durable features along with the free output monitoring software make the GPD-Series suitable for any lab as well as the LED industry.

SPECIFICATIONS												
	GPD-2303S		GPD-3303S			GPD-4303S			GPD-3303D			
OUTPUT												
Channel Voltage	CH1	CH2	CH1	CH2	CH3	CH1	CH2	CH3	CH4	CH1	CH2	CH3
	0-30V	0-30V	0-30V	0-30V	2.5/3.3/5.0V	0-30V	0-30V	0-5V or 5.001V-10V	0-5V	0-30V	0-30V	2.5/3.3/5.0V
Current	0-3A	0-3A	0-3A	0-3A	3A	0-3A	0-3A	0-3A or 0-1A	0-1A	0-3A	0-3A	3A
CONSTANT VOLTAGE OPERATION												
Regulation	Line regulation $\leq 0.01\%+3mV$ Load regulation $\leq 0.01\%+3mV$ (rating current $\leq 3A$); $\leq 0.02\%+5mV$ (rating current $>3A$)											
Ripple & Noise	$\leq 1mV_{rms}$ (5Hz-1MHz)											
Recovery Time	$\leq 100\mu s$ (50%Load change, Minimum load 0.5A)											
Temp.Coefficient	$\leq 300ppm / ^\circ C$											
CONSTANT CURRENT OPERATION												
Regulation	Line regulation $\leq 0.2\%+3mA$; Load regulation $\leq 0.2\%+3mA$											
Ripple Current	$\leq 3mA_{rms}$											
TRACKING OPERATION												
Regulation of PAR.	Line regulation $\leq 0.01\%+3mV$ Load regulation $\leq 0.01\%+3mV$ (rating current $\leq 3A$); $\leq 0.02\%+5mV$ (rating current $>3A$)											
Regulation of SER.	Line regulation $\leq 0.01\%+5mV$ Load regulation $\leq 100mV$											
Tracking Error	$\leq 0.1\%\pm 10mV$ (10 - 30V) no load, with load added load regulation $\leq 100mV$											
METER												
Display	Voltage: 5 digits 0.4" LED Display (full scale:32V) Current: 4 digits 0.4" LED Display (full scale:3.2A)						Voltage:3 digits 0.4"LED Display Current:3 digits 0.4"LED Display					
Resolution	Voltage: 1mV Current: 1mA						Voltage:100mV Current:10mA					
Program Accuracy(25 $\pm 5^\circ C$)	Voltage: $\pm(0.03\%$ of RDG +10 digits) Current: $\pm(0.3\%$ of RDG +10 digits)						Voltage: $\pm(0.5\%$ of RDG+2 digits) Current: $\pm(0.5\%$ of RDG+2 digits)					
Readback Accuracy(25 $\pm 5^\circ C$)	Voltage: $\pm(0.03\%$ of RDG +10 digits) Current: $\pm(0.3\%$ of RDG +10 digits)						Voltage: $\pm(0.5\%$ of RDG+2 digits) Current: $\pm(0.5\%$ of RDG+2 digits)					
CH3 SPECIFICATIONS												
Output Voltage			(2.5V/3.3V/5V) $\pm 8\%$			0-5V / 5-10V			(2.5V/3.3V/5V) $\pm 8\%$			
Output Current			3A			0-3A / 0-1A			3A			
Regulation (25 $\pm 5^\circ C$)	-		Line regulation $\leq 0.01\%+3mV$ Load regulation $\leq 0.01\%+3mV$			Line regulation $\leq 0.01\%+3mV$ Load regulation $\leq 0.01\%+3mV$			Line regulation $\leq 0.01\%+3mV$ Load regulation $\leq 0.01\%+3mV$			
Repple & Noise			$\leq 1mV_{rms}$ (5Hz-1MHz)			$\leq 2mV_{rms}$ (5Hz-1MHz)			$\leq 1mV_{rms}$ (5Hz-1MHz)			
KEY LOCK												
Yes												
MEMERY SAVE/RECALL												
4 sets												
POWER SOURCE												
AC100V/120V/220V/230V $\pm 10\%$, 50/60Hz; Power consumption : 490VA max.												
DIMENSION & WEIGHT												
210(W) x 130 (H) x 265(D) mm ; Approx. 7kg												

ORDERING INFORMATION

- GPD-2303S** GPD-2303S 2 Channels, 180W Programmable Linear DC Power Supply
- GPD-3303S** GPD-3303S 3 Channels, 195W Programmable Linear DC Power Supply
- GPD-4303S** GPD-4303S 4 Channels, 195W Programmable Linear DC Power Supply
- GPD-3303D** GPD-3303D 3 Channels, 195W Programmable Linear DC Power Supply

ACCESSORIES :

- User Manual x 1, Power cord x 1
- GPD-2303S** Test Lead GTL-104A x 2, European Test Lead GTL-204Ax2, GTL-201A x 1
- GPD-3303S** Test Lead GTL-104A x 2, GTL-105A x 1; European Test Lead GTL-203A x 1, GTL-204A x 2, GTL-201A x 1
- GPD-4303S** Test Lead GTL-104A x 2, GTL-105A x 2; European Test Lead GTL-203A x 2, GTL-204A x 2, GTL-201A x 1
- GPD-3303D** Test Lead GTL-104A x 2, GTL-105A x 1; European Test Lead GTL-203A x 1, GTL-204A x 2, GTL-201A x 1

OPTIONAL ACCESSORIES

- GTL-246 USB Cable

FREE DOWNLOAD

- PC Software PC Software including Data Log
- Driver Labview Driver

Programmable Dual-range Linear D.C. Power Supply



PSM-2010/3004/6003



FEATURES

- * Single Output Dual Range Max. 200W
- * High Resolution: 1mV/1mA
- * Stable & Clear Power: 0.01% Load/Line Regulation, 350µVrms Ripple
- * 100 Sets Memory
- * Auto Step Running With Timer Setting
- * Safety Design: OVP, OCP & OTP ; Output ON/OFF Control(OCP Provides Delay Setting to Prevent Trip of High Start-Up Current)
- * Self-Test and Software Calibration
- * Highly Visible Vacuum-Fluorescent Display
- * Front and Rear Output Terminal
- * Standard Interface : RS-232C, GPIB
- * Optional European Jack Type Terminal

European Type Jack Terminal



Rear Panel



The PSM-Series is a single output / dual range, 120W or 200W, programmable linear DC power supply. OVP, OCP, OTP, and output On/Off control protect the PSM-Series and their loads from unexpected conditions. High resolution, high regulation, and low ripple are maintained at 1mV/1mA, 0.01%, and <math><350\mu\text{Vrms}</math>, respectively. Operation and configuration is simplified with a digital interface and a clear LCD display. Standard features include; store/recall output memories, automatic stepping with timers for continuous testing and self-testing and software calibration features to reduce maintenance overhead. SCPI programming, LabVIEW drivers, RS-232C and GPIB interfaces enable easy automated test system integration and remote control. The PSM-Series is an ideal choice for high precision applications such as QA verification and product development.

SPECIFICATIONS		PSM-2010	PSM-3004	PSM-6003
DC OUTPUT				
Low Range		0 – 8V/20A	0 – 15V/7A	0 – 30V/6A
High Range		0 – 20V/10A	0 – 30V/4A	0 – 60V/3.3A
CONSTANT VOLTAGE OPERATION				
Regulation (% of output + offset)		Load regulation $\leq 0.01\% + 2\text{mV}$; Line regulation $\leq 0.01\% + 2\text{mV}$		
Ripple & Noise		$< 350\mu\text{Vrms}/3\text{mVpp}$	$< 350\mu\text{Vrms}/2\text{mVpp}$	$\leq 50\text{V}: < 500\mu\text{Vrms}/3\text{mVpp}$ $> 50\text{V}: < 1\text{mVrms}/3\text{mVpp}$
CONSTANT CURRENT OPERATION				
Regulation (% of output + offset)		Load regulation $\leq 0.01\% + 250\mu\text{A}$; Line regulation $\leq 0.01\% + 250\mu\text{A}$		
Ripple & Noise		$< 2\text{mArms}$		
RESOLUTION				
Programming	Voltage	1mV	1mV	2mV
	Current	1mA	0.5mA	0.5mA
Readback	Voltage	0.5mV	0.5mV	1mV
	Current	1mA	0.1mA	0.5mA
Front Panel	Voltage	1mV		
	Current	1mA($<10\text{A}$), 10mA($\geq 10\text{A}$)		
OVP/OCP	Voltage	10mV		
	Current	10mA		
ACCURACY				
Programming	Voltage	0.05% + 10mV		
	Current	0.2% + 10mA		
Readback	Voltage	0.05% + 5mV		
	Current	0.15% + 5mA		
OVP/OCP	Voltage	0.1% + 10mV		
	Current	0.4% + 10mA		
TRANSIENT RESPONSE				
		$< 50\mu\text{sec}$ (for output to recover within 15mV following a change in output current from full load to half load)		
COMMAND PROCESSING TIME				
		100 ms		
VOLTAGE PROGRAMMING RESPONSE TIME (for resistive load)(10% – 90%)				
Voltage Up	Full Load	95 ms	50 ms	80 ms
	No Load	45 ms	20 ms	100 ms
Voltage Down	Full Load	30 ms	45 ms	30 ms
	No Load	450 ms	400 ms	450 ms
STABILITY (% of output + offset)				
Voltage		0.02% + 1mV		
Current		0.1% + 1mA		
MEMORY				
Store/Recall		100 sets		
TEMPERATURE COEFFICIENT PER °C \pm (% of Output + Offset)				
Voltage		0.01% + 3mV		
Current		0.02% + 3mA		
POWER SOURCE				
		AC 100V/120V/220V $\pm 10\%$, 230V (- 6% – + 10%), 50/60Hz		
INTERFACE				
		Standard RS-232C , GPIB		
DIMENSIONS & WEIGHT				
		230(W) x 140(H) x 380(D) ; Approx. 10kg		

ORDERING INFORMATION

- PSM-2010 200W Single Output, Programmable Power Supply
- PSM-6003 200W Single Output, Programmable Power Supply
- PSM-3004 120W Single Output, Programmable Power Supply

ACCESSORIES :

User manual x 1, Power cord x 1, Test lead GTL-104A x 1, European test lead GTL-204A x 1, Ground lead GTL-201A x 1 (European terminal), Sense lead GTL-202 x 1 (European Terminal)

OPTION

Opt. 01 GRA-407 Rack Mount Kit

OPTIONAL ACCESSORIES

- GTL-232 RS-232C Cable, 9-pin Female to 9-pin, Null Modem for PC Computer
- GTL-248 GPIB Cable, Double Shielded, 2000mm
- GRA-407 Rack Mount Kit

FREE DOWNLOAD

- PC Software PC Software including Data Log ; Remote Control Software
- Driver Labview Driver ; PSM VB Example ; PSM VC++ Example

Programmable Linear D.C. Power Supply



PSS-2005/3203



FEATURES

- * Digitized Programmable Interface
- * High Resolution 10mV, 1mA
- * High Stability, Low Drift
- * Over-Voltage, Over-Current, Over Temperature Protection
- * Intelligent Fan Control (Change by Output Power)
- * Built-in Buzzer Alarm
- * LabVIEW Driver
- * Standard Interface : RS-232C
- * Optional Interface : GPIB (IEEE-488.2)
- * Optional European Jack Type Terminal

European Type Jack Terminal



Rear Panel



The PSS-Series is a single output, 96W or 100W, programmable linear DC power supply. OVP, OCP, and OTP protect the PSS series and their loads from unexpected conditions. The LCD panel simultaneously displays output and other parameters and the regulated cooling fan ensures low noise for comfortable operation. RS232C and GPIB interfaces, SCPI command sets and LABVIEW drivers make remote control and ATE software development easier. (Note: only RS-232C or GPIB can be installed at one time) The compact PSS series is suitable for any high resolution bench-top or rack mount application.

SPECIFICATIONS		
	PSS-2005	PSS-3203
OUTPUT		
Voltage	0 – 20V	0 – 32V
Current	0 – 5A	0 – 3A
OVP	0 – 21V	0 – 33V
LOAD REGULATION		
Voltage	≤ 3mV (≤ 5mV, rating current > 3.0A)	
Current	≤ 3mA (≤ 5mA, rating current > 3.0A)	
LINE REGULATION		
Voltage	≤ 3mV	
Current	≤ 3mA	
RESOLUTION		
Voltage	10mV	
Current	1mA (2mA, rating current > 3.0A)	
OVP	10mV	
PROGRAM ACCURACY (25 ± 5°C)		
Voltage	≤ 0.05%+20mV	
Current	≤ 0.1%+5mA (+10mA, rating current > 3.0A)	
OVP	≤ 0.05%+20mV	
RIPPLE & NOISE (20Hz – 20MHz)		
Voltage	Ripple ≤ 1mVrms/3mVp-p ; Noise ≤ 2mVrms/30mVp-p	
Current	≤ 3mArms (≤ 5mArms, rating current > 3.0A)	
TEMPERATURE COEFFICIENT (0 – 40°C)		
Voltage	≤ 100ppm+3mV	
Current	≤ 100ppm+3mA	
REARBACK RESOLUTION		
Voltage	10mV	
Current	1mA (2mA, rating current > 3.0A)	
REARBACK ACCURACY(25 ± 5°C)		
Voltage	≤ 0.05%+10mV	
Current	≤ 0.1%+5mA (10mA rating current > 3.0A)	
REARBACK TEMPERATURE COEFFICIENT		
Voltage	≤ 100ppm+10mV	
Current	≤ 100ppm+5mA (10mA rating current > 3.0A)	
RESPONSE TIME		
Voltage Up (10%~90%)	≤ 100mS	
Voltage Down (90%~10%)	≤ 100mS (≥10% rating load)	
DRIFT		
Voltage	≤ 100ppm+10mV	
Current	≤ 150ppm+10mA	
INTERFACE		
Standard : RS-232C; Option : GPIB		
POWER SOURCE		
AC 100V/120V/220V ±10%, 230V (+10%/-6%), 50/60Hz		
DIMENSIONS & WEIGHT		
108(W) x 142(H) x 318(D) mm, Approx. 4.8kg		

ORDERING INFORMATION

PSS-2005 100W Single Output Programmable D.C. Power Supply

PSS-3203 96W Single Output Programmable D.C. Power Supply

ACCESSORIES :

User manual x 1, Power cord x 1 Test lead GTL-104A x 1 (PSS-2005) or GTL-105A x 1 (PSS-3203)
European Test Lead GTL-204A x 1 (PSS-2005) or GTL-203A x 1 (PSS-3203)

OPTION

Opt.01 : GPIB Interface (factory installed)

OPTIONAL ACCESSORIES

GTL-232 RS-232C Cable, 9-pin Female to 9-pin, null Modem for Computer

GRA-408 Rack Adapter Panel (19" 4U)

GTL-248 GPIB Cable, Double Shielded, 2000mm

FREE DOWNLOAD

PC Software PC Software including Data Log ; Remote Control Software
Driver LabView Driver

Note : When Opt.01 GPIB interface is ordered, the standard interface RS-232C will be deleted.

Multiple Output Programmable Linear D.C. Power Supply



PPE-3323

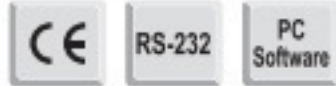

FEATURES

- * Easy Operation with UP/DOWN Key
- * High Resolution: 10mV, 1mA
- * Over Voltage Protection (by Software)
- * 50 Sets Memory
- * Self Test and Software Calibration
- * Auto Step Running With Timer Setting
- * Triple Output
- * Auto Tracking
- * RS-232C Communication
- * High Stability, Low Drift
- * 4 Digit Display
- * IEC Safety Regulation

Rear Panel



The PPE-Series is a 3-channel, programmable linear DC power supply with 207W output. The PPE-Series features OVP and OCP and is compliant with all major safety standards (UL, CSA, and IEC) for safe, reliable operation. The digital interface and smart features simplify operation and configuration with output limit store/recall functions, tracking, serial operation, and auto stepping for continuous testing. The series has PC software and SCPI commands as standard for remote control and PC interfacing via RS-232C. The versatile PPE-Series is ideal for high-level applications requiring high resolution, multiple outputs, and an extra level of safety.

OUTPUT	
Voltage	0~+32V, 0~-32V, 3.3V/5V FIXED
Current	0~+3A, 0~-3A, 3A FIXED
OVP	0~+33V, 0~-33V
LOAD REGULATION	
Voltage	≤ 6mV
Current	≤ 3mA
LINE REGULATION	
Voltage	≤ 3mV
Current	≤ 3mA
RESOLUTION	
Voltage	10mV (20mV rating voltage > 36V)
Current	1mA (2mA rating current > 3.5A)
OVP	10mV (20mV rating voltage > 36V)
PROGRAM ACCURACY (25 ± 5°C)	
Voltage	≤ 0.05% + 25mV (+ 50mV rating voltage > 36V)
Current	≤ 0.2% + 10mA
OVP	≤ 2% + 0.6V
RIPPLE & NOISE (20Hz ~ 20MHz)	
Voltage	Ripple 1mVrms / 3mVp-p Noise 2mVrms / 30mVp-p
Current	≤ 3mA rms (≤ 5mA rms rating current > 3.5A)
TEMPERATURE COEFFICIENT (0~40°C)	
Voltage	≤ 100ppm + 3mV
Current	≤ 150ppm + 3mA
REARBACK RESOLUTION/ACCURACY (25 ± 5°C)	
Voltage	10mV (20mV rating voltage > 36V)
Current	1mA (2mA rating current > 3.5A)
Voltage	≤ 0.05% + 25mV (+ 50mV rating voltage > 36V)
Current	≤ 0.2% + 10mA
RESPONSE TIME	
VOLTAGE UP 10% ~ 90%	≤ 100mS
VOLTAGE DOWN 90% ~ 10%	≤ 100mS (≥ rating load)
REARBACK TEMPERATURE COEFFICIENT	
Voltage	≤ 100ppm + 10mV (+ 20mV rating voltage > 36V)
Current	≤ 150ppm + 10mA
DRIFT	
Voltage	≤ 100ppm + 10mV
Current	≤ 150ppm + 10mA
TRACK OPERATION	
Tracking Error	≤ 0.1% + 50mV
Series Regulation	≤ 50mV
PARALLEL OPERATION (PPT-Series only)	
Program Accuracy (25 ± 5°C)	Voltage ≤ 0.05% + 25mV (+ 50mV rating voltage > 36V) Current ≤ 0.2% + 20mA OVP ≤ 2% + 0.6V
Load Effect	Voltage ≤ 3mV rear output (≤ 6mV front output) Current ≤ 6mA (≤ 12mA rating current > 3.5A)
Source Effect	Voltage ≤ 3mV; Current ≤ 6mA
MEMORY	
Store/Recall	50 sets
TIMER	
Setting Time	1 second ~ 99 minutes (Max. 99 minutes x 50 sets)
Resolution Function	1 second for output working loop (Auto Step running)
STANDARD INTERFACE	
RS-232C	
POWER SOURCE	
AC 100V/120V/ 220V/240V ±10%, 50/60Hz	
DIMENSIONS & WEIGHT	
255(W) x 145(H) x 346(D) mm; Approx. 10kg	

PPE-3323 207W Triple Output Programmable D.C. Power Supply					
Model	Independent	Series	Parallel	Display Type	Weight (kg)
PPE-3323	(0~32V/0~3A)x2, (5V/3A)FIXED	64V/3A	32V/6A	LED	10
ACCESSORIES : User manual x 1, Power cord x 1, Test lead GTL-105A x 3					
GRA-401 Rack Mount Kit					
FREE DOWNLOAD					
PC Software Remote Control Software					

Multiple Output Programmable Linear D.C. Power Supply



PPT-1830/PPT-3615



FEATURES

- * Easy Operation with UP/DOWN Key
- * High Resolution: 10mV, 1mA
- * Over Voltage Protection, Over Current Protection (PPT-Series by Hardware)
- * 50 Sets Memory
- * Self Test and Software Calibration
- * Auto Step Running With Timer Setting
- * FRONT/REAR Output and Sense Switch Selectable
- * Triple Output
- * Auto Series and Parallel Operation
- * Auto Tracking
- * IEEE-488.2 and SCPI Compatible Command set
- * GPIB Standard Interface
- * LabVIEW Driver
- * High Stability, Low Drift
- * 4 Digit Display
- * IEC Safety Regulation

Rear Panel



The PPT-Series is a 3-channel, programmable linear DC power supply with 138W or 126W outputs. The PPT-Series features OVP and OCP and is compliant with all major safety standards (UL, CSA, and IEC) for safe, reliable operation. For extra precision, the PPT-Series includes remote sensing that adds an extra level of precision by compensating cable losses between loads. The digital interface and smart features simplify operation and configuration with output limit store/recall functions, automatic tracking, automatic serial or parallel operation, and auto stepping for continuous testing. The series has Labview drivers and SCPI commands as standard for remote control and PC interfacing via GPIB. The versatile PPT-Series is ideal for high-level applications requiring high resolution, multiple outputs, and an extra level of safety.

SPECIFICATIONS		
MODEL	PPT-1830	PPT-3615
OUTPUT		
Voltage	0-18Vx2, 0-6Vx1	0-36Vx2, 0-6Vx1
Current	0-3Ax2, 0-5Ax1	0-1.5Ax2, 0-3Ax1
OVP	0-20Vx2, 0-7Vx1	0-38.5Vx2, 0-7Vx1
LOAD REGULATION		
Voltage	≤ 3mV rear output (≤ 6mV front output)	
Current	≤ 3mA (≤ 6mA rating current > 3.5A)	
LINE REGULATION		
Voltage	≤ 3mV	
Current	≤ 3mA	
RESOLUTION		
Voltage	10mV (20mV rating voltage > 36V)	
Current	1mA (2mA rating current > 3.5A)	
OVP	10mV (20mV rating voltage > 36V)	
PROGRAM ACCURACY (25 ± 5°C)		
Voltage	≤ 0.05% + 25mV (+ 50mV rating voltage > 36V)	
Current	≤ 0.2% + 10mA	
OVP	≤ 2% + 0.6V	
RIPPLE & NOISE (20Hz ~ 20MHz)		
Voltage	Ripple 1mVrms / 3mVp-p Noise 2mVrms / 30mVp-p	
Current	≤ 3mA rms (≤ 5mA rms rating current > 3.5A)	
TEMPERATURE COEFFICIENT (0-40°C)		
Voltage	≤ 100ppm + 3mV	
Current	≤ 150ppm + 3mA	
REARBACK RESOLUTION/ACCURACY (25 ± 5°C)		
Voltage	10mV (20mV rating voltage > 36V)	
Current	1mA (2mA rating current > 3.5A)	
Voltage	≤ 0.05% + 25mV (+ 50mV rating voltage > 36V)	
Current	≤ 0.2% + 10mA	
RESPONSE TIME		
VOLTAGE UP 10% ~ 90%	≤ 100mS	
VOLTAGE DOWN 90% ~ 10%	≤ 100mS (≥ rating load)	
REARBACK TEMPERATURE COEFFICIENT		
Voltage	≤ 100ppm + 10mV (+ 20mV rating voltage > 36V)	
Current	≤ 150ppm + 10mA	
DRIFT		
Voltage	≤ 0.03% + 6mV	
Current	≤ 0.1% + 6mA	
TRACK OPERATION		
Tracking Error	≤ 0.1% + 50mV	
Series Regulation	≤ 50mV	
PARALLEL OPERATION		
Program Accuracy (25 ± 5°C)	Voltage ≤ 0.05% + 25mV (+ 50mV rating voltage > 36V) Current ≤ 0.2% + 20mA OVP ≤ 2% + 0.6V	
Load Effect	Voltage ≤ 3mV rear output (≤ 6mV front output) Current ≤ 6mA (≤ 12mA rating current > 3.5A)	
Source Effect	Voltage ≤ 3mV; Current ≤ 6mA	
MEMORY		
Store/Recall	50 sets	
TIMER		
Setting Time	1 second ~ 255 minutes (Max. 255 minutes x 50 sets)	
Resolution	1 second	
Function	for output working loop (Auto Step running)	
STANDARD INTERFACE		
GPIB		
POWER SOURCE		
AC 100V/120V/220V/240V ± 10%, 50/60Hz		
DIMENSIONS & WEIGHT		
255(W) x 145(H) x 346(D) mm; Approx. 10kg		

ORDERING INFORMATION

PPT-1830 138W Triple Output Programmable D.C. Power Supply
PPT-3615 126W Triple Output Programmable D.C. Power Supply

Model	Independent	Series	Parallel	Display Type	Weight (kg)
PPT-1830	(0-18V/0-3A)x2, (0-6V/0-5A)x1	36V/3A	18V/6A	LED	10
PPT-3615	(0-36V/0-1.5A)x2, (0-6V/0-3A)x1	72V/1.5A	36V/3A	LED	10

ACCESSORIES :
User manual x 1, Power cord x 1, Test lead GTL-105A x 3, GTL-104A x 3

OPTIONAL ACCESSORIES

GRA-401 Rack Mount Kit
GTL-248 GPIB Cable, Double Shielded, 2000mm
GTL-204A European test lead x 3

FREE DOWNLOAD

Driver LabView Driver

Multiple Output Programmable Linear D.C. Power Supply



PST-3201/3202



FEATURES

- * Digitized Programmable Interface
- * High Resolution 10mV, 1mA
- * 192 x 128 LCD Display, Simultaneously Shows Settings and Measuring Result
- * Over-Voltage, Over-Current, Over Temperature Protection
- * Intelligent Fan Control (Changes by Output Power)
- * 100 Sets Memory
- * Auto Step Running With Timer Setting
- * Auto Series and Parallel Function
- * LabVIEW Driver
- * Standard Interface : RS-232C
- * Optional Interface : GPIB (IEEE-488.2)
- * Optional European Jack Type Terminal

European Type Jack Terminal



Rear Panel



PST-Series is a 3-channel, 96W or 158W, programmable linear DC power supply. High resolution is maintained at 10mV, 1mA (3A). OVP, OCP, and OTP protect the PST-Series and its loads from unexpected conditions. PST-Series is capable of independent, series or parallel operation for increased flexibility. The large LCD display conveniently displays all outputs and configurations simultaneously to simplify operation. The programmable interface allows automatic stepping, 100 sets of memory and comprehensive timing operations. GPIB and RS232C interfaces, Labview drivers and SCPI compatibility allow easy ATE software development and remote control. The versatile PST-Series is ideal for high resolution, multiple output, automated operations such as production testing and rack mounting systems.

SPECIFICATIONS		
	PST-3202	PST-3201
OUTPUT		
Voltage	0-32Vx2, 0-6Vx1	0-32Vx3
Current	0-2Ax2, 0-5Ax1	0-1Ax3
OVP	0-33Vx2, 0-7Vx1	0-33Vx3
LOAD REGULATION		
Voltage	≤ 3mV (≤ 5mV rating current >3.0A)	
Current	≤ 3mA (≤ 5mA rating current >3.0A)	
LINE REGULATION		
Voltage	≤ 3mV	
Current	≤ 3mA	
RESOLUTION		
Voltage	10mV	
Current	1mA (2mA, rating current >3.0A)	
OVP	10mV	
PROGRAM ACCURACY(25 ± 5°C)		
Voltage	≤ 0.05%+20mV	
Current	≤ 0.1%+5mA (+10mA, rating current>3.0A)	
OVP	≤ 0.05%+20mV	
RIPPLE & NOISE(20Hz~20MHz)		
Voltage	Ripple: ≤ 1mVrms/3mVp-p ; Noise: ≤ 2mVrms/30mVp-p	
Current	≤ 3mArms (≤ 5mArms, rating current >3.0A)	
TEMPERATURE COEFFICIENT (0 ~ 40 °C)		
Voltage	≤ 100ppm+3mV	
Current	≤ 100ppm+3mA	
REARBACK RESOLUTION		
Voltage	10mV(20mV, rating voltage >36V)	
Current	1mA(2mA, rating current >3.0A)	
REARBACK ACCURACY(25 ± 5°C)		
Voltage	≤ 0.05%+10mV(+20mV, rating voltage >36V)	
Current	≤ 0.1%+5mA(+10mA, rating current>3.0A)	
REARBACK TEMPERATURE COEFFICIENT		
Voltage	≤ 100ppm+10mV(+20mV, rating voltage >36V)	
Current	≤ 150ppm+10mA(+20mA, rating current >3.0A)	
RESPONSE TIME		
Voltage Up (10%~90%)	≤ 100mS	
Voltage Down (90%~10%)	≤ 100mS (≥ 10% rating load)	
DRIFT		
Voltage	≤ 100ppm+10mV(+20mV, rating voltage >36V)	
Current	≤ 150ppm+10mA	
TRACK OPERATION		
Tracking Error	≤ 0.1%+20mV	
Series(Load Effect)	≤ 20mV	
PARALLEL OPERATION		
Program Accuracy(25 ± 5°C)	Voltage ≤ 0.05%+20mV, Current ≤ 0.1%+10mA, OVP ≤ 0.05%+20mV	
Load Effect	Voltage ≤ 3mV(≤ 5mV, rating current>3.0A); Current ≤ 6mA	
Source Effect	Voltage ≤ 3mV; Current ≤ 6mA	
MEMORY		
Store/Recall	100 Sets	
TIMER		
Setting Time	0.1 second~99 Minutes 59 second (Max. 99 Minutes 59 second x 100)	
Resolution	0.1 second	
Function	Auto step running (for output working loop)	
INTERFACE		
Standard	RS-232C ; Option: GPIB (IEEE488.2)	
POWER SOURCE		
AC	100V/120V/220V ± 10%, 230V(+10%/-6%), 50/60Hz	
DIMENSIONS & WEIGHT		
Dimensions	230(W) x 140(H) x 380(D) mm , Approx.10kg	

ORDERING INFORMATION

PST-3202 158W Triple Output Programmable D.C. Power Supply
 PST-3201 96W Triple Output Programmable D.C. Power Supply

Model	Independent	Series	Parallel	Display Type	Weight (kg)
PST-3201	(0-32V/0-1A)x3	64V/1A	32V/2A	LCD	10
PST-3202	(0-32V/0-2A)x2,(0-6V/0-5A)x1	64V/2A	32V/4A	LCD	10

ACCESSORIES :

User manual x 1, Power cord x 1, Test lead: GTL-104A x 3 (PST-3202) or GTL-105A x 3 (PST-3201)
 European test lead: GTL-204A x 3 (PST-3202) or GTL-203A x 3 (PST-3201)

OPTION

Opt.01 GPIB Interface (factory installed)

OPTIONAL ACCESSORIES

GRA-407 Rack Mount Kit
 GTL-248 GPIB Cable, Double Shielded, 2000mm
 GTL-232 RS-232C Cable, 9-pin Female to 9-pin, null Modem for Computer

FREE DOWNLOAD

PC Software PC Software including Data Log ; Remote Control Software
 Driver LabView Driver

Multiple Output Linear D.C. Power Supply



GPE-X323 Series



FEATURES

- * 1/2/3/4 Independent Isolated Output
- * 4.3 Inch LCD Display
- * Setting & Read Back Resolution 100mV/10mA (*1)
- * Output ON/OFF Switch
- * Analog Control (Remote I/O) for Output ON/OFF
- * Set View Function for Checking an Original V/I Setting During Output On
- * Key Lock Function
- * Tracking Series and Parallel Operation
- * Optional European Jack Type Terminal

European Type Jack Terminal



Rear Panel



The GPE-X323 series is a cutting edge, economical linear DC Power supply. The GPE-X323 series features output power from 192 to 217 watts, three independent isolated output channels (for GPE-3323), high resolution, low noise, high reliability, and compact size. The GPE-X323 series has a built-in digital panel control design to replace conventional control method. This unique design allows the GPE-X323 series linear DC power supply to provide users with more efficient functionalities, including set view and key lock so as to expedite the operation process. The key lock function protects DUTs by preventing others from changing voltage and current parameters. Additionally, output key light facilitates users in clearly reading the operational status of power supply.

SPECIFICATIONS										
	GPE-4323				GPE-3323			GPE-2323		GPE-1326
OUTPUT MODE										
Number of Channel	CH1	CH2	CH3	CH4	CH1	CH2	CH3	CH1	CH2	CH1
Voltage	0~32V	0~32V	0~5V	0~15V	0~32V	0~32V	5V	0~32V	0~32V	0~32V
Current	0~3A	0~3A	0~1A	0~1A	0~3A	0~3A	5A	0~3A	0~3A	0~6A
Tracking Series Voltage	0~64V				0~64V			0~64V		-
Tracking Parallel Current	0~6A				0~6A			0~6A		-
CONSTANT VOLTAGE OPERATION										
Line Regulation	$\leq 0.01\%+3mV$									
Load Regulation	$\leq 0.01\%+3mV$ (rating current $\leq 3A$)									
	$\leq 0.02\%+5mV$ (rating current $> 3A$)									
Ripple & Noise	$\leq 1mV_{rms}$ (5Hz~1MHz)									
Recovery Time	$\leq 100\mu s$ (50% Load Change, minimum load 0.5A)									
CONSTANT CURRENT OPERATION										
Line Regulation	$\leq 0.2\%+3mA$									
Load Regulation	$\leq 0.2\%+3mA$									
Ripple & Noise	$\leq 3mArms$									
TRACKING OPERATION (CH1,CH2)										
Tracking Error	$\leq 0.1\%+10mV$ of Master (0~32V) No Load, with Load add load regulation $\leq 100mV$									
Parallel Regulation	Line: $\leq 0.01\%+3mV$									
	Load: $\leq 0.01\%+3mV$ (rating current $\leq 3A$)									
	$\leq 0.02\%+5mV$ (rating current $> 3A$)									
Series Regulation	Line: $\leq 0.01\%+5mV$; Load: $\leq 100mV$									
Ripple & Noise	$\leq 2mV_{rms}$, 5Hz ~ 1MHz									
CH3 OPERATION FOR (GPE-3323)										
Output Voltage	5.0V, $\pm 5\%$									
Output Current	5A									
Line Regulation	$\leq 3mV$									
Load Regulation	$\leq 5mV$									
Ripple & Noise	1mVrms (5Hz~1MHz)									
METER										
Voltage Resolution	100mV (*1)									
Current Resolution	10mA (*1)									
Setting Accuracy	Voltage $\pm (0.1\%$ of reading +30mV); Current $\pm (0.3\%$ of reading +6mA)									
Readback Accuracy	Voltage $\pm (0.1\%$ of reading +30mV); Current $\pm (0.3\%$ of reading +6mA)									
INSULATION										
Chassis and Terminal	20M Ω or above (DC 500V)									
Chassis and AC Cord	30M Ω or above (DC 500V)									
ENVIRONMENT CONDITION										
Operation Temp	0~40 $^{\circ}C$									
Storage Temp	-10~70 $^{\circ}C$									
Operating Humidity	$\leq 80\%$ RH									
Storage Humidity	$\leq 70\%$ RH									
OTHER										
Power Source	AC100V/120V/220V $\pm 10\%$; 230V(+10%~-6%); 50/60Hz									
Dimensions & Weight	210(W)x 155(H) x 306(D) mm ; Approx. 7kg									

ORDERING INFORMATION

- GPE-1326 Single Channel, 192W Linear DC Power Supply
- GPE-2323 2 Channels, 192W Linear DC Power Supply
- GPE-3323 3 Channels, 217W Linear DC Power Supply
- GPE-4323 4 Channels, 212W Linear DC Power Supply

ACCESSORIES :

User Manual (CD) x 1 ; Power Cord x 1

- GPE-1326 Test Lead GTL-104A x 1 ; GTL-105A x 1 ; or European GTL-204A x 1, GTL-203A x 1
- GPE-2323 Test Lead GTL-104A x 2 ; or European GTL-204A x 2
- GPE-3323 Test Lead GTL-104A x 3 ; or European GTL-204A x 3
- GPE-4323 Test Lead GTL-104A x 2 ; GTL-105A x 2 or European GTL-204A x 2, GTL-203A x 2

Note : (*1) For a higher resolution (10mV/1mA), please follow the setting procedure of the user manual on p35.
When using a higher resolution, the current or voltage adjustment may be limited by the knob sensibility.

Multiple Output Linear D.C. Power Supply



GPS-2303/3303/4303



FEATURES

- * 2, 3 and 4 Independent Isolated Output
- * Four "3 Digits" LED Displays
- * 0.01% Load and Line Regulation
- * Low Ripple and Noise
- * Tracking Operation and Auto Series/Parallel Operation
- * Output ON/OFF Switch
- * Output Voltage and Current Setting When Output Disable (Except for GPS-2303)
- * Fan Speed Control Circuit to Minimize Fan Noise
- * Over Load and Reverse Polarity Protection
- * Optional European Jack Type Terminal

European Type Jack Terminal



GPS-001

Voltage/Current protection Knob



Rear Panel



GPS-3303

The GPS Series linear power supplies have 2-4 independent output channels, 180W to 200W output, overload and reverse polarity protection as well as an output ON/OFF switch for safety. The tracking mode switches allow voltage/current to be output in parallel or series and the intelligent fan reduces noise. The GPS-Series is an entry level general purpose power supply recognized for their affordability in education, laboratories and industry.

SPECIFICATIONS									
	GPS-4303				GPS-3303			GPS-2303	
OUTPUT MODE									
	CH1	CH2	CH3	CH4	CH1	CH2	CH3	CH1	CH2
Voltage	0 – 30V	2.2 – 5.2V	8 – 15V		0 – 30V	5V Fixed		0 – 30V	
Current	0 – 3A	1A Max.	1A Max.		0 – 3A	3A Max.		0 – 3A	
Tracking Series Voltage	0 – 60V			0 – 60V		0 – 60V	
Tracking Parallel Current	0 – 6A				0 – 6A			0 – 6A	
CONSTANT VOLTAGE OPERATION (CH1, CH2)									
Line Regulation	≤ 0.01% + 3mV								
Load Regulation	≤ 0.01% + 3mV (rating current ≤ 3A) ≤ 0.02% + 5mV (rating current > 3A)								
Ripple & Noise	≤ 1mVrms, 5Hz – 1MHz								
Recovery Time	≤ 100 μS (50% Load change, Minimum load 0.5A)								
CONSTANT CURRENT OPERATION (CH1, CH2)									
Line Regulation	≤ 0.2% + 3mA								
Load Regulation	≤ 0.2% + 3mA								
Ripple & Noise	≤ 3mArms								
TRACKING OPERATION (CH1, CH2)									
Tracking Error	≤ 0.5% + 10mV of CH1								
Series Regulation	≤ 0.01% + 5mV								
Load Regulation	≤ 300mV								
Ripple & Noise	≤ 2mVrms, 5Hz – 1MHz								
CH3 OPERATION (for GPS-3303/4303)									
CH3 Voltage	GPS-4303 : 2.2V – 5.2V, GPS-3303 : 5V Fix								
Line Regulation	≤ 5mV								
Load Regulation	≤ 15mV								
Ripple & Noise	≤ 2mVrms, 5Hz – 1MHz								
Current Output	GPS-4303 : 1A, GPS-3303 : 3A								
CH4 OPERATION (for GPS-4303)									
CH4 VOLTAGE	8V – 15V								
Line Regulation	≤ 5mV								
Load Regulation	≤ 10mV								
Ripple & Noise	≤ 2mVrms, 5Hz – 1MHz								
Current Output	1A								
METER									
Digital	3 digits 0.5" LED display GPS-4303/3303 Out ON Accuracy ± (0.5% of rdg + 2 digits) GPS-4303/3303 Out OFF Accuracy ± (0.5% of rdg + 8 digits) GPS-2303 Accuracy ± (0.5% of rdg + 2 digits)								
INSULATION									
Chassis and Terminal	≥ DC 500V / 20MΩ								
Chassis and AC Cord	≥ DC 500V / 30MΩ								
POWER SOURCE									
AC 100V/120V/220V±10%, 230V(+10%–6%), 50/60Hz									
DIMENSIONS & WEIGHT									
255(W) x 145(H) x 265(D) mm, Approx. 7 kg									

ORDERING INFORMATION

- GPS-4303 4-channels, 200W Multiple Output Linear DC Power Supply
- GPS-3303 3-channels, 195W Multiple Output Linear DC Power Supply
- GPS-2303 2-channels, 180W Multiple Output Linear DC Power Supply

ACCESSORIES :

- User manual x 1, Power cord x 1,
- GPS-4303 : Test lead GTL-104A x 2, GTL-105A x 2 ; European test lead GTL-203A x 2, GTL-204A x 2, GTL-201 x 1
- GPS-3303 : Test lead GTL-104A x 2, GTL-105A x 1 ; European test lead GTL-203A x 1, GTL-204A x 2, GTL-201 x 1
- GPS-2303 : Test lead GTL-104A x 2 ; European test lead GTL-204A x 2, GTL-201A x 1

OPTIONAL ACCESSORIES

- GPS-001 Voltage/Current Protection Knob

Triple Output Linear D.C. Power Supply



GPC-3060D/6030D

The GPC-Series is a triple output, 375W, linear DC power supply. Channel 1 and 2 are fully adjustable (model dependant) and channel 3 is fixed at 5V/3A with ripple and noise at less than 2mVrms. Overload and reverse polarity protection keep GPC-Series and its loads safe from unexpected conditions. GPC features continuous or dynamic internal load selection and series or parallel tracking for application flexibility. The GPC-Series is an ideal solution for inexpensive bench-top applications requiring low noise and multiple outputs.

FEATURES

- * Triple Output
- * Auto Tracking
- * Auto Series and Parallel Operation
- * Constant Voltage and Constant Current Operation
- * Low Ripple and Noise
- * Internal Select for Continuous or Dynamic Load
- * Overload and Reverse Polarity Protection
- * 3 1/2 Digits 0.5" LED Display
- * 5V, 3A Fixed Output

SPECIFICATIONS	
OPERATION MODE	
Independent	Two independent outputs and 5V fixed output Output from 0 to rating volts and 0 to rating amperes
Series	Output from 0 to \pm rating volts at rating amperes each
Parallel	Output from 0 to double rating volts at rating amperes Output from 0 to double rating amperes at rating volts
CONSTANT VOLTAGE OPERATION	
Regulation	Line regulation $\leq 0.01\% + 3mV$ Load regulation $\leq 0.01\% + 3mV$ (rating current $\leq 3A$) $\leq 0.01\% + 5mV$ (rating current $\leq 10A$) $\leq 0.02\% + 5mV$ (rating current $\geq 10A$)
Ripple & Noise	$\leq 1mVrms$ 5Hz – 1MHz
Recovery Time	$\leq 100\mu S$ (50% Load change, Minimum load 0.5A)
CONSTANT CURRENT OPERATION	
Regulation	Line regulation $\leq 0.2\% + 3mA$ Load regulation $\leq 0.2\% + 5mA$
Ripple Current	$\leq 3mA_{rms}$
5V FIXED OUTPUT	
Regulation	Line regulation $\leq 5mV$ Load regulation $\leq 10mV$
Ripple & Noise	$\leq 2mVrms$
Voltage Accuracy	$5V \pm 0.25V$
Output Current	3A
TRACKING OPERATION	
Tracking Error	$\leq 0.5\% + 10mV$ of the master
Series Regulation	$\leq 300mV$
METER	
Digital	3 1/2 digits 0.5" LED display Accuracy $\pm(0.5\%$ of rdg + 2 digits)
INSULATION	
Chassis and Terminal	100M Ω or above (DC 1000V)
Chassis and AC Cord	100M Ω or above (DC 1000V)
POWER SOURCE	
AC 100V/120V/220V/240V $\pm 10\%$, 50/60Hz	
DIMENSIONS	
255(W) x 145(H) x 420(D) mm	

ORDERING INFORMATION

Model	Independent	Series	Parallel	Weight (kg)
GPC-6030D	375W D.C. Power Supply (0 – 60V/0 – 3A) x 2 , (5V/3A MAX) x 1	120V 3A	60V 6A	18.5
GPC-3060D	375W D.C. Power Supply (0 – 30V/0 – 6A) x 2 , (5V/3A MAX) x 1	60V 6A	30V 12A	18.5
ACCESSORIES :				
User manual x 1 , Power cord x 1				
Test lead GTL-105A x 1 ($\leq 3A$) or GTL-104A x 2 ($\leq 10A$)				
OPTIONAL ACCESSORIES				
GRA-401	Rack Mount Kit			

Linear D.C. Power Supply



The GPR-H Series consists of single output linear DC power supplies with voltage outputs rating from 8V to 300V. The series includes overload and reversed polarity protection to protect devices under test from being damaged due to inappropriate operation. The internal select for dynamic loads is often used for amplifier testing. It can support high pulse current derived from dynamic processes as well as support low noise and noise, which make it suitable for high-end bench-top applications requiring precision. Its rear panel supports output wiring. These features combined into one assembly allow the GPR-H Series to predominate in applications requiring high voltage or high current.

GPR-H Series



FEATURES

- * 0.01% High Regulation
- * Constant Voltage and Constant Current Operation
- * Internal Select for Continuous or Dynamic Load
- * Low Ripple and Noise
- * Overload and Reverse Polarity Protection
- * 3 1/2 Digit 0.5" LED Display
- * Internal Select for Continuous or Dynamic Load (for GPR-3510HD/GPR-6060D/GPR-7550D)

SPECIFICATIONS	
CONSTANT VOLTAGE OPERATION	
Regulation	Line regulation $\leq 0.01\% + 3\text{mV}$ Load regulation $\leq 0.01\% + 5\text{mV} (<10\text{A})$ $\leq 0.02\% + 5\text{mV} (\geq 10\text{A})$
Ripple & Noise	$\leq 1\text{mVrms } 5\text{Hz} - 1\text{MHz}$
Recovery Time	$\leq 100\mu\text{S}$ (50% load change, minimum load 0.5A)
Output Range	0 to rating voltage continuously adjustable
CONSTANT CURRENT OPERATION	
Regulation	Line regulation $\leq 0.2\% + 3\text{mA}$ Load regulation $\leq 0.2\% + 5\text{mA}$
Ripple Current	$\leq 5\text{mA rms} (\leq 20\text{A}), \leq 10\text{mA rms} (\leq 30\text{A})$ $\leq 20\text{mA rms} (\leq 50\text{A})$
Output Range	0 to rating current continuously adjustable
METER	
Type	3 1/2 Digit 0.5" LED display
Accuracy	$\pm (0.5\% \text{ of rdg} + 2 \text{ digits})$
INSULATION	
Chassis and Terminal	100M Ω or above (DC 1000V)
Chassis and AC Cord	100M Ω or above (DC 1000V)
POWER SOURCE	
AC 100V/120V/220V/240V $\pm 10\%$, 50/60Hz	
DIMENSIONS	
254(W) x 152(H) x 456(D) mm	

Rear Panel



ORDERING INFORMATION

Model	Output Volts (V)	Output Amps (A)	Weight (kg)	
GPR-0830HD	240W D.C. Power Supply	0 – 8	0 – 30	18.5
GPR-1820HD	360W D.C. Power Supply	0 – 18	0 – 20	18.5
GPR-3510HD	350W D.C. Power Supply	0 – 35	0 – 10	18.5
GPR-6060D	360W D.C. Power Supply	0 – 60	0 – 6	18.5
GPR-7550D	375W D.C. Power Supply	0 – 75	0 – 5	18.5
GPR-11H30D	330W D.C. Power Supply	0 – 110	0 – 3	13.5
GPR-30H10D	300W D.C. Power Supply	0 – 300	0 – 1	13.5

ACCESSORIES :

User manual x 1, Power cord x 1
Test lead GTL-105A x 1 ($\leq 3\text{A}$) or GTL-104A x 1 ($\leq 10\text{A}$) or Not Available ($>10\text{A}$)

OPTIONAL ACCESSORIES

GTL-122 Test Lead, U-type to Alligator Test Lead, Max. Current 40A, 1200mm

Note: CE Approved Only for GPR-1820HD, GPR-3510HD, GPR-7550D, GPR-11H30D
Rear-Panel Output Only for GPR-0830HD, GPR-1820HD

Linear D.C. Power Supply



The GPR-M Series is a single output, 180W, linear DC power supply which featuring all the same functions as the GPR-H Series but for lower power demands. Like the GPR-H Series, the GPR-M Series is suitable for high-end precision bench top applications. Low load and line regulation for both constant voltage and constant current mode ensure reliable, predictable output. Overload and reverse polarity protection as well as internal selection for dynamic or constant load are standard.

GPR-M Series



FEATURES

- * 0.01% High Regulation
- * Constant Voltage and Constant Current Operation
- * Internal Select for Continuous or Dynamic Load
- * Low Ripple and Noise
- * Overload and Reverse Polarity protection
- * 3 1/2 Digit 0.5" LED Display

SPECIFICATIONS	
CONSTANT VOLTAGE OPERATION	
Regulation	Line regulation $\leq 0.01\% + 3\text{mV}$ Load regulation $\leq 0.01\% + 5\text{mV}$ ($<10\text{A}$) Load regulation $\leq 0.02\% + 5\text{mV}$ ($\geq 10\text{A}$)
Ripple & Noise	$\leq 1\text{mVrms}$ 5Hz – 1MHz
Recovery Time	$\leq 100\mu\text{S}$ (50% load change, minimum load 0.5A)
Output Range	0 to rating voltage continuously adjustable
CONSTANT CURRENT OPERATION	
Regulation	Line regulation $\leq 0.2\% + 3\text{mA}$ Load regulation $\leq 0.2\% + 3\text{mA}$
Ripple Current	$\leq 3\text{mA}_{\text{rms}}$
Output Range	0 to rating current continuously adjustable
METER	
Digital	3 1/2 Digits 0.5" LED display Accuracy $\pm (0.5\% \text{ of rdg} + 2 \text{ digits})$
INSULATION	
Chassis and Terminal	$20\text{M}\Omega$ or above (DC 500V)
Chassis and AC Cord	$30\text{M}\Omega$ or above (DC 500V)
POWER SOURCE	
AC 100V/120V/220V/240V $\pm 10\%$, 50/60Hz	
DIMENSIONS	
254(W) x 152(H) x 349(D) mm	

ORDERING INFORMATION				
Model		Output Volts (V)	Output Amps (A)	Weight (kg)
GPR-1810HD	180W D.C. Power Supply	0 – 18	0 – 10	11.5
GPR-3060D	180W D.C. Power Supply	0 – 30	0 – 6	11.5
GPR-6030D	180W D.C. Power Supply	0 – 60	0 – 3	11.5
ACCESSORIES :				
User manual x 1 , Power cord x 1				
Test lead GTL-105A x 1 (GPR-6030D)				
GTL-104A x 1 (GPR-1810HD/3060D)				
OPTIONAL ACCESSORIES				
GRA-401 Rack Adapter Panel (19" , 4U)				

Linear D.C. Power Supply



GPS-1830D/1850D/3030D



GPS-3030DD



FEATURES

- * Light and Compact Design
- * 0.01% High Regulation
- * Constant Voltage and Constant Current Operation
- * Remote Control for External Programmability
- * Internal Select for Continuous or Dynamic Load
- * Low Ripple and Noise
- * Overload and Reverse Polarity Protection
- * Series or Parallel Operation
- * Optional European Type Jack Terminal for GPS-3030D/GPS-3030DD

European Type Jack Terminal



The GPS-Series is a single output, 54W to 90W, linear DC power supply. The GPS-Series has digital display meters with varying power outputs. The GPS-Series features overload and reverse polarity protection as well as high regulation and low ripple/noise that are maintained at 0.01% and < 1mVrms, respectively. Continuous or dynamic internal load selection accommodates applications such as pulsed current. Remote control terminals offer programming and operation from an external device.

SPECIFICATIONS	
CONSTANT VOLTAGE OPERATION	
Regulation	Line regulation $\leq 0.01\% + 3mV$ Load regulation $\leq 0.01\% + 3mV$ (rating current $\leq 3A$) $\leq 0.01\% + 5mV$ (rating current $> 3A$)
Ripple & Noise	$\leq 0.5mVrms$ 5Hz ~ 1MHz (rating current $\leq 3A$) $\leq 1mVrms$ 5Hz ~ 1MHz (rating current $> 3A$)
Recovery Time	$\leq 100\mu S$ (50% load change, minimum load 0.5A)
Temp. Coefficient	$\leq 300 ppm / ^\circ C$
Output Range	0 to rating voltage continuously adjustable
CONSTANT CURRENT OPERATION	
Regulation	Line regulation $\leq 0.2\% + 3mA$ Load regulation $\leq 0.2\% + 3mA$
Ripple Current	$\leq 3mA_{rms}$
Output Range	0 to rating current continuously adjustable (Hi/Lo range switchable)
METER	
Digital	3½ digits 0.5" LED display (GPS-1830D/1850D/3030D) 3½ digits 0.39" LED display (GPS-3030DD) Accuracy $\pm(0.5\%$ of rdg + 2 digits)
INSULATION	
Chassis and Terminal	20M Ω or above (DC 500V)
Chassis and AC Cord	30M Ω or above (DC 500V)
POWER SOURCE	
AC 100V/120V/220V/240V $\pm 10\%$, 50/60Hz	
DIMENSIONS	
128(W) x 145(H) x 285(D) mm	

ORDERING INFORMATION

Model	Output Volts(V)	Output Amps(A)	Weight (kg)
GPS-1830D	0 – 18	0 – 3	4
GPS-1850D	0 – 18	0 – 5	5
GPS-3030D	0 – 30	0 – 3	5
GPS-3030DD	0 – 30	0 – 3	5

ACCESSORIES :

- User manual x 1 , Power cord x 1
- Test lead GTL-105A x 1 ($\leq 3A$) or GTL-104A x 1 ($\leq 10A$)
- European test lead GTL-203A x 1 ($\leq 3A$) or GTL-204A x 1 ($\leq 10A$)

NOTE



AC POWER SOURCES

GW Instek AC Power Sources currently can be divided into three categories. Programmable AC/DC Power Source, Programmable AC Power Source, AC Power Source.

AC Power Source ASR-3000/ASR-2000 Series not only plays the role as a precision AC/DC power source but also a powerful analyzer. It contains abundant features for the testing and characteristic analysis of power supplies, electronic devices, components and modules.

The APS-7000 Series is programmable linear AC Power Source, with the height of 2U and output frequency range is 45~500Hz. The maximum rated output for APS-7050 is 500VA, 310Vrms, 4.2Arms and APS-7100 is 1000VA, 310Vrms, 8.4Arms. The APS-7000 Series comprises nine measurement and test functions and provides user interface similar to that of AC Power Meter.

PRODUCTS

- Programmable AC/DC Power Source
 - Programmable AC Power Source
 - AC Power Source
-

AC POWER SOURCES

AC POWER SOURCES

Programmable Switching AC/DC Power Source

GW Instek not only provides compact and lightweight switching AC/DC power sources but also features AC, DC and AC+DC power outputs and the real time measurements of Vrms, Vavg, Vpeak, Irms, IpkH, Iavg, Ipeak, P, S, Q, PF, CF, 40 th-order Voltage Harmonic and Current Harmonic. Four signal sources are collocated as Internal (INT), External (EXT), Internal+ External (ADD), and External Synchronization (SYNC) to flexibly output power so as to meet customers' demands. The powerful sequence function is very suitable for producing arbitrary waveforms. 16 sets of arbitrary waveform storage space and 10 sets of panel setting memory space are provided for data storage and setting input.

Linear AC Power Source

GW Instek recommends linear AC power source for AC power with the requirements of high accuracy, high stability and low ripple/noise. Programmable AC Power Source APS-7000 is suitable for simulating AC power outputs and it has 9 measurement functions (Vrms, Irms, F, Ipk, W, VA, PF, Ipk hold, CF), 7 waveform modes, Sequence mode, Simulate mode, and Surge/Dip Control Mode etc. Purpose AC power source applications, non-programmable AC source APS-7000E Series, with high precision and THD of less than 0.5%, is the ideal selection.

2K~4KVA PROGRAMMABLE SWITCHING AC/DC POWER SOURCE

Model	Output Capacity	Output Freq.	Output Voltage	Max. Current	Display Type	Weight(kg)	Page
ASR-3200	2KVA	1~999.9Hz	AC 100V Range 0.0V~200.0V AC 200V Range 0.0V~400.0V DC 100V Range -285V~+285V DC 200V Range -570V~+570V	AC 100V Range 20A AC 200V Range 10A DC 100V Range 20A DC 200V Range 10A	LCD	25	D73-78
ASR-3300	3KVA	1~999.9Hz	AC 100V Range 0.0V~200.0V AC 200V Range 0.0V~400.0V DC 100V Range -285V~+285V DC 200V Range -570V~+570V	AC 100V Range 30A AC 200V Range 15A DC 100V Range 30A DC 200V Range 15A	LCD	25	
ASR-3400	4KVA	1~999.9Hz	AC 100V Range 0.0V~200.0V AC 200V Range 0.0V~400.0V DC 100V Range -285V~+285V DC 200V Range -570V~+570V	AC 100V Range 40A AC 200V Range 20A DC 100V Range 40A DC 200V Range 20A	LCD	25	
ASR-3400HF	4KVA	1~5000Hz	AC 100V Range 0.0V~200.0V AC 200V Range 0.0V~400.0V DC 100V Range -285V~+285V DC 200V Range -570V~+570V	AC 100V Range 40A AC 200V Range 20A DC 100V Range 40A DC 200V Range 20A	LCD	25	

PROGRAMMABLE SWITCHING AC/DC POWER SOURCE

Model	Output Capacity	Output Freq.	Output Voltage	Max. Current	Display Type	Weight(kg)	Page
ASR-2050/ ASR-2050R	500VA	1~999.9Hz	AC 100V Range 0.0V~175.0V AC 200V Range 0.0V~350.0V DC 100V Range -250.0V~+250.0V DC 200V Range -500.0V~+500.0V	AC 100V Range 5A AC 200V Range 2.5A DC 100V Range 5A DC 200V Range 2.5A	LCD	11.5 ASR-2000 Series 10.5 ASR-2000R Series	D79-82
ASR-2100/ ASR-2100R	1000VA	1~999.9Hz	AC 100V Range 0.0V~175.0V AC 200V Range 0.0V~350.0V DC 100V Range -250.0V~+250.0V DC 200V Range -500.0V~+500.0V	AC 100V Range 10A AC 200V Range 5A DC 100V Range 10A DC 200V Range 5A	LCD	11.5 ASR-2000 Series 10.5 ASR-2000R Series	

PROGRAMMABLE LINEAR AC POWER SOURCE

Model	Output Capacity	Output Freq.	Output Voltage	Max. Current	Display Type	Weight(kg)	Page
APS-7050	500 VA	45~500Hz Option: 45~999.9Hz	0~310V, 0~155V Option: 0~600V	2.1A, 4.2A	LCD	24	D83-86
APS-7100	1000 VA	45~500Hz Option: 45~999.9Hz	0~310V, 0~155V Option: 0~600V	4.2A, 8.4A	LCD	38	
APS-7200	2000 VA	45~500Hz Option: 45~999.9Hz	0~310V, 0~155V Option: 0~600V	8.4A, 16.8A	LCD	90	
APS-7300	3000 VA	45~500Hz Option: 45~999.9Hz	0~310V, 0~155V Option: 0~600V	12.6A, 25.2A	LCD	128	

LINEAR AC POWER SOURCE

Model	Output Capacity	Output Freq.	Output Voltage	Max. Current	Display Type	Weight(kg)	Page
APS-7050E	500 VA	45~500Hz	0~310V, 0~155V	2.1A, 4.2A	LCD	24	D87-88
APS-7100E	1K VA	45~500Hz	0~310V, 0~155V	4.2A, 8.4A	LCD	38	

Programmable AC/DC Power Source



ASR-3000 Series

NEW



FEATURES

- * Output Rating: AC 0 ~ 400 Vrms, DC 0 ~ ± 570 V
- * Output Frequency up to 999.9 Hz (5kHz for ASR-3400HF only)
- * DC Output (100% of Rated Power)
- * Measurement Items: Vrms, Vavg, Vpeak, Irms, IpkH, Iavg, Ipeak, P, S, Q, PF, CF
- * Voltage and Current Harmonic Analysis (THDv, THDi)
- * Remote Sensing Capability
- * OCP, OPP, OTP, AC Fail Detection and Fan Fail Alarm
- * Support Arbitrary Waveform Function
- * Output Capacity: 2kVA/3kVA/4kVA
- * Customized Phase Angle for Output On/Off
- * Sequence and Simulation Function (up to 10 sets)
- * Interface(std): USB, LAN, RS-232, GPIB
- * Built-in External Control I/O and External Signal Input
- * Built-in Output Relay Control
- * Memory Function (up to 10 sets)
- * Built-in Web Server

The ASR-3000 Series is an AC+DC power source, featuring high-speed DC voltage rising and falling time ($\leq 100\mu s$). There are four models of the series: ASR-3200(2kVA), ASR-3300(3kVA) and ASR-3400/3400HF (4kVA). The series can provide rated power output during AC output and DC output. Ten ASR-3000 Series output modes are available, including 1) AC power output mode (AC-INT Mode), 2) DC power output mode (DC-INT Mode), 3) AC/DC power output mode (AC+DC-INT Mode), 4) External AC signal source mode (AC-EXT Mode), 5) External AC/DC signal source mode (AC+DC-EXT Mode), 6) External AC signal superimposition mode (AC-ADD Mode), 7) External AC/DC signal superimposition mode (AC+DC-ADD Mode), 8) External AC signal synchronization mode (AC-SYNC Mode), 9) External AC/DC signal synchronization mode (AC+DC-SYNC Mode) 10) External DC voltage control of AC output mode(AC-VCA).

ASR-3000 Series is ideal for the development of On-board Chargers, Server Powers, LED modules, AC Motors, AC Fans, UPS and various electronic components, as well as for testing applications of automotive electrical equipment and home appliances.

The ASR-3000 Series provides users with waveform output capabilities including 1) Sequence mode generates waveform fallings, surges, sags, changes and other abnormal power line conditions; 2) Arbitrary waveform function allows users to store/upload user-defined waveforms; and 3) Simulate mode simulates power outage, voltage rise, voltage fall, and frequency variations. When the ASR-3000 Series power source outputs, it can also measure Vrms, Vavg, Vpeak, Irms, Iavg, Ipeak, IpkH, P, S, Q, PF, CF, 100th-order Voltage Harmonic and Current Harmonic. In addition, the remote sensing function ensures accurate voltage output, and the Customized Phase Angle for Output On/Off function can set the start and end angles of the voltage output according to the test requirements. The protection limits of V-Limit, Ipeak-Limit and F-Limit can be set according to user requirements. Over voltage limit, OCP, OPP will protect the DUT during the output process. The Fan Fail Alarm function and the AC fail alarm function are also designed in the ASR-3000 Series.

The front panel of the ASR-3000 Series provides a universal socket or a European socket, which allows users to plug and use so as to save wiring time. Since the power socket specification has a maximum current of 15A, the rear panel of ASR-3000 Series is designed with a current circuit breaker. When the socket current is greater than 15A, it will automatically open the circuit to protect users. The ASR-3000 Series supports I/O interface and is standardly equipped with USB, LAN, External I/O, RS-232C and GPIB.

ASR-002 External three phase control unit



- * Basis Requirement of ASR-002 to ASR-Series
- 1. Must be the three same models of ASR-Series
- 2. To ASR-2000 Series, the Opt01: RS-232+GPIB interface is required
- * Functions of ASR-Series are limited when conducts to ASR-002
- 1. No DC Output
- 2. Measurement Items: only current(A), power(W)and PF for each phase
- 3. No Voltage and Current Harmonic Analysis
- 4. No Remote Sensing Capability
- 5. No Arbitrary Waveform Function
- 6. No Sequence and Simulation Function
- 7 Not supported External Control I/O
- 8. No memory Function
- 9. Only support USB, no LAN port for communication

GRA-442-J Rack Mount Adapter(JIS)



GRA-442-E Rack Mount Adapter(EIA)



GTL-137 Output power wire



APS-008 Air inlet filter



GPW-005 Power cord



GPW-006 Power cord



GPW-007 Power cord



SPECIFICATIONS

		ASR-3200	ASR-3300	ASR-3400	ASR-3400HF
INPUT RATING (AC)					
NOMINAL INPUT VOLTAGE		200 Vac to 240 Vac			
INPUT VOLTAGE RANGE		180 Vac to 264 Vac			
PHASE		Single phase, Two-wire			
NOMINAL INPUT FREQUENCY		50 Hz to 60 Hz			
INPUT FREQUENCY RANGE		47 Hz to 63 Hz			
MAX. POWER CONSUMPTION		2500 VA or less	3750 VA or less	5000 VA or less	5000 VA or less
POWER FACTOR ^{†1}	200Vac	0.95 (TYP)			
MAX. INPUT CURRENT	200Vac	15 A	22.5 A	30 A	30 A
†1. For an output voltage of 100 V / 200 V (100V / 200V range), maximum current, and a load power factor of 1.					
AC MODE OUTPUT RATINGS (AC rms)					
VOLTAGE	Setting Range ^{†1}	0.0 V to 200.0 V / 0.0 V to 400.0 V			
	Setting Resolution	0.1 V			
	Accuracy ^{†2}	±(1 % of set + 1 V / 2 V)			
OUTPUT PHASE		Single phase, Two-wire			
MAXIMUM CURRENT ^{†3}	100 V	20 A	30 A	40 A	40 A
	200 V	10 A	15 A	20 A	20 A
MAXIMUM PEAK CURRENT ^{†4}	100 V	120 A	180 A	240 A	160 A
	200 V	60 A	90 A	120 A	80 A
LOAD POWER FACTOR		0 to 1 (leading phase or lagging phase)			
POWER CAPACITY		2000 VA	3000 VA	4000 VA	4000 VA
FREQUENCY	Setting Range	AC Mode: 40.0 Hz to 999.9 Hz, AC+DC Mode: 1 Hz to 999.9 Hz			AC Mode: 40.0 Hz to 5000 Hz, AC+DC Mode: 1 Hz to 5000 Hz
	Setting Resolution	0.01 Hz (1.00 to 99.99 Hz), 0.1 Hz (100.0 to 999.9 Hz)			0.01 Hz (1.00 to 99.99 Hz), 0.1 Hz (100.0 to 999.9 Hz) 1 Hz (1000 to 5000 Hz)
	Accuracy	0.02% of set (23 °C ± 5 °C)			
	Stability ^{†5}	± 0.005%			
OUTPUT ON PHASE		0° to 359° variable (setting resolution 1°)			
DC OFFSET ^{†6}		Within ± 20 mV (TYP)			
†1. 100 V / 200 V range.					
†2. For an output voltage of 20 V to 200 V / 40 V to 400 V, an output frequency of 45 Hz to 65 Hz, no load, and 23 °C ± 5°C.					
†3. For an output voltage of 1 V to 100 V / 2 V to 200 V. Limited by the power capacity when the output voltage is 100 V to 200 V / 200 V to 400 V. If there is the DC superimposition, the current of AC+DC mode satisfies the maximum current. In the case of lower than 40 Hz, and the power rating temperature, the maximum current will be decrease.					
†4. With respect to the capacitor-input rectifying load. Limited by the maximum current.					
†5. For 45 Hz to 65 Hz, the rated output voltage, no load and the resistance load for the maximum current, and the operating temperature.					
†6. In the case of the AC mode and 23°C ± 5°C.					
OUTPUT RATING FOR DC MODE					
VOLTAGE	Setting Range ^{†1}	-285 V to +285 V / -570 V to +570 V			
	Setting Resolution	0.1 V			
	Accuracy ^{†2}	±(1 % of set + 1 V / 2 V)			
MAXIMUM CURRENT ^{†3}	100 V	20 A	30 A	40 A	40 A
	200 V	10 A	15 A	20 A	20 A
MAXIMUM PEAK CURRENT ^{†4}	100 V	120 A	180 A	240 A	160 A
	200 V	60 A	90 A	120 A	80 A
POWER CAPACITY		2000 W	3000 W	4000 W	4000 W
†1. 100 V / 200 V range.					
†2. For an output voltage of -285 V to -28.5 V, +28.5 V to +285 V / -570 V to -57 V, +57 V to +570 V, no load, and 23 °C ± 5°C.					
†3. For an output voltage of 1.4 V to 100 V / 2.8 V to 200 V. Limited by the power capacity when the output voltage is 100 V to 250 V / 200 V to 500 V.					
†4. Limited by the maximum current.					
OUTPUT VOLTAGE STABILITY					
LINE REGULATION ^{†1}		0.2% or less			
LOAD REGULATION ^{†2}		0.5% or less (0 to 100%, via output terminal)			
RIPPLE NOISE ^{†3}		1 Vrms / 2 Vrms (TYP)			
†1. Power source input voltage is 200 V, 220 V, or 240 V, no load, rated output.					
†2. For an output voltage of 100 V to 200 V / 200 V to 400 V, a load power factor of 1, stepwise change from an output current of 0 A to maximum current (or its reverse), using the output terminal on the rear panel.					
†3. For 5 Hz to 1 MHz components in DC mode using the output terminal on the rear panel.					
OUTPUT VOLTAGE WAVEFORM DISTORTION RATIO, OUTPUT VOLTAGE RESPONSE TIME, EFFICIENCY					
TOTAL HARMONIC DISTORTION (THD) ^{†1}		< 0.2% @50/60Hz < 0.3% @<500Hz < 0.5% @500.1Hz~999.9Hz			< 0.2% @50/60Hz < 0.5% @<500Hz < 1.0% @500.1Hz~2000Hz < 2.0% @2100Hz~5000Hz
OUTPUT VOLTAGE RESPONSE TIME ^{†2}		100 μs (TYP)			
EFFICIENCY ^{†3}		80 % or more			
†1. At an output voltage of 50 V to 200 V / 100 V to 400 V, a load power factor of 1, and in AC mode.					
†2. For an output voltage of 100 V / 200 V, a load power factor of 1, with respect to stepwise change from an output current of 0 A to the maximum current (or its reverse).					
†3. For AC mode, at an output voltage of 100 V / 200 V, maximum current, and load power factor of 1.					
MEASURED VALUE DISPLAY					
VOLTAGE	RMS, AVG Value ^{†1}	Resolution	0.1 V		
		Accuracy ^{†2}	For 45 Hz to 65 Hz and DC: ±(0.5 % of reading + 0.5 V / 1 V) For all other frequencies: ±(0.7 % of reading + 1 V / 2 V)		
	PEAK Value	Resolution	0.1 V		
		Accuracy	For 45 Hz to 65 Hz and DC: ±(2 % of reading) + 1 V / 2 V		
CURRENT	RMS, AVG Value	Resolution	0.01 A		
		Accuracy ^{†3}	For 45 Hz to 65 Hz and DC: ±(0.5 % of reading+0.1 A/0.05 A) For all other frequencies: ±(0.7 % of reading+0.2 A/0.1 A)	For 45 Hz to 65 Hz and DC: ±(0.5 % of reading+0.15 A/0.08 A) For all other frequencies: ±(0.7 % of reading+0.3 A/0.15 A)	For 45 Hz to 65 Hz and DC: ±(0.5 % of reading+0.2 A/0.1 A) For all other frequencies: ±(0.7 % of reading+0.4 A/0.2 A)
	PEAK Value	Resolution	0.1 A		
		Accuracy ^{†4}	For 45 Hz to 65 Hz and DC: ±(2 % of reading) + 0.5 A/0.25 A	For 45 Hz to 65 Hz and DC: ±(2 % of reading) + 0.8 A/0.4 A	For 45 Hz to 65 Hz and DC: ±(2 % of reading) + 1 A/0.5 A
POWER	Active (W)	Resolution	1 W		
		Accuracy ^{†5}	±(2 % of reading + 2 W)	±(2 % of reading + 3 W)	±(2 % of reading + 4 W)
	Apparent (VA)	Resolution	1 VA		
		Accuracy ^{†6}	±(2 % of reading + 2 VA)	±(2 % of reading + 3 VA)	±(2 % of reading + 4 VA)
	Reactive (VAR)	Resolution	1 VAR		
		Accuracy ^{†7}	±(2 % of reading + 2 VAR)	±(2 % of reading + 3 VAR)	±(2 % of reading + 4 VAR)
LOAD POWER FACTOR		Range	0.000 to 1.000		
		Resolution	0.001		
LOAD CREST FACTOR		Range	0.00 to 50.00		
		Resolution	0.01		
HARMONIC VOLTAGE EFFECTIVE VALUE (RMS) PERCENT (%) (AC-INT and 50/60 Hz only)		Range	Up to 100th order of the fundamental wave		
		Full Scale	200 V / 400 V, 100%		
		Resolution	0.1 V, 0.1%		
		Accuracy ^{†8}	Up to 20th : ±(0.2 % of reading + 0.5 V / 1 V) 20th to 100th : ±(0.3 % of reading + 0.5 V / 1 V)		

Programmable AC/DC Power Source



ASR-3000 Series

SPECIFICATIONS			ASR-3200	ASR-3300	ASR-3400	ASR-3400HF
HARMONIC CURRENT EFFECTIVE VALUE (RMS) PERCENT (%) (AC-INT and 50/60 Hz only)	Range		Up to 100th order of the fundamental wave			
	Full Scale		20 A / 10 A, 100%	30 A / 15 A, 100%	40 A / 20 A, 100%	
	Resolution		0.01 A, 0.1%			
	Accuracy*		Up to 20th ±(1 % of reading+0.4 A/0.2 A) 20th to 100th ±(1.5 % of reading+0.4 A/0.2 A)	Up to 20th ±(1 % of reading+0.6 A/0.3 A) 20th to 100th ±(1.5 % of reading+0.6 A/0.3 A)	Up to 20th ±(1 % of reading+0.8 A/0.4 A) 20th to 100th ±(1.5 % of reading+0.8 A/0.4 A)	
<small>*1. The voltage display is set to RMS in AC/AC+DC mode and AVG in DC mode. *2. AC mode: For an output voltage of 20 V to 200 V / 40 V to 400 V and 23 °C ± 5 °C. DC mode: For an output voltage of 28.5 V to 285 V / 57 V to 570 V and 23 °C ± 5 °C. *3. An output current in the range of 5 % to 100 % of the maximum current, and 23 °C ± 5 °C. *4. An output current in the range of 5 % to 100 % of the maximum peak current in AC mode, an output current in the range of 5 % to 100 % of the maximum instantaneous current in DC mode, and 23 °C ± 5 °C. The accuracy of the peak value is for a waveform of DC or sine wave. *5. For an output voltage of 50 V or greater, an output current in the range of 10 % to 100 % of the maximum current, DC or an output frequency of 45 Hz to 65 Hz, and 23 °C ± 5 °C. *6. The apparent and reactive powers are not displayed in the DC mode. *7. The reactive power is for the load with the power factor 0.5 or lower. *8. An output voltage in the range of 20 V to 200 V / 40 V to 400 V and 23 °C ± 5 °C.</small>						
OTHERS						
PROTECTIONS			UVP, OCP, OTP, OPP, Fan Fail			
DISPLAY			TFT-LCD, 4.3 inch			
MEMORY FUNCTION			Store and recall settings, Basic settings: 10 (0-9 numeric keys)			
ARBITRARY WAVE	Number of Memories		16 (nonvolatile)			
	Waveform Length		4096 words			
INTERFACE	Standard	USB	Type A: Host, Type B: Slave, Speed: 1.1/2.0, USB-CDC, USB-TMC			
		LAN	MAC Address, DNS IP Address, User Password, Gateway IP Address, Instrument IP Address, Subnet Mask			
		RS-232C	Complies with the EIA-RS-232 specifications			
		EXT Control	External Signal Input; External Control I/O			
		GPIB	SCPI-1993, IEEE 488.2 compliant interface			
INSULATION RESISTANCE			500 Vdc, 30 MΩ or more			
Between input and chassis, output and chassis, input and output						
WITHSTAND VOLTAGE			1500 Vac, 1 minute			
Between input and chassis, output and chassis, input and output						
EMC			EN 61326-1, EN 61326-2-1, EN 61000-3-2, EN 61000-3-3, EN 61000-3-11, EN 61000-3-12 EN 61000-4-2/-4-3/-4-4/-4-5/-4-6/-4-8/-4-11/-4-34, EN 55011 (Class A), EN 55032			
SAFETY			EN 61010-1			
ENVIRONMENT	Operating Environment		Indoor use, Overvoltage Category II			
	Operating Temperature Range		0 °C to 40 °C			
	Storage Temperature Range		-10 °C to 70 °C			
	Operating Humidity Range		20 % to 80 % RH (no condensation)			
	Storage Humidity Range		90 % RH or less (no condensation)			
	Altitude		Up to 2000 m			
DIMENSIONS & WEIGHT			430(W)x176(H)x530(D) mm (not including protrusions); Approx. 25kg			

ORDERING INFORMATION

ASR-3200	2kVA Programmable AC/DC Power Source
ASR-3300	3kVA Programmable AC/DC Power Source
ASR-3400	4kVA Programmable AC/DC Power Source
ASR-3400HF	4kVA Programmable AC/DC Power Source

ACCESSORIES :

CD (User manual/Programming manual), Safety guide, Input Terminal Cover, Output terminal cover include remote sensing, GRA-442-E Rack mount adapter(EIA), GTL-246 USB Cable

OPTIONAL ACCESSORIES

GPW-005	Power cord, 3m, 105°C, UL/CSA type	GTL-232	RS232C Cable, approx. 2m
GPW-006	Power cord, 3m, 105°C, VDE type	GTL-248	GPIB Cable, approx. 2m
GPW-007	Power cord, 3m, 105°C, PSE type	ASR-002	External three phase control unit for IP2W, IP3W, 3P4W output
GRA-442-J	Rack mount adapter(JIS)	APS-008	Air inlet filter
GRA-442-E	Rack mount adapter(EIA)		
GTL-137	Output power wire(load wire_10AWG:50A, 600V/sense wire_16AWG:20A, 600V)		

* European output outlet(factory installed)

A. OPERATING AREA FOR ASR-3000 SERIES

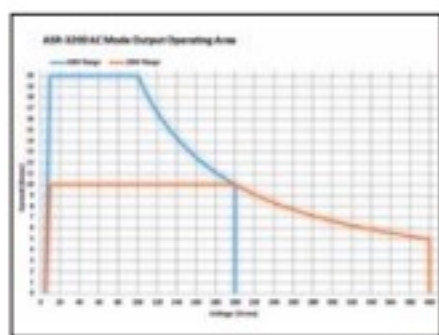

AC Output for ASR-3200

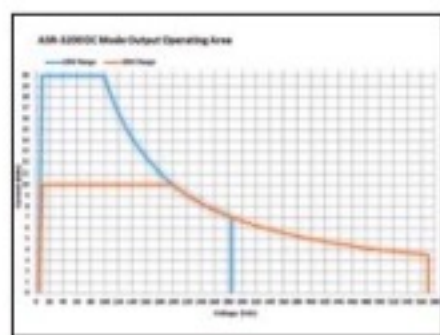

DC Output for ASR-3200

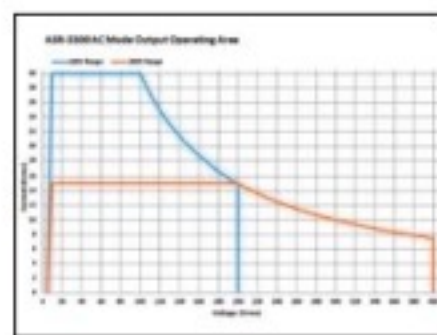

AC Output for ASR-3300

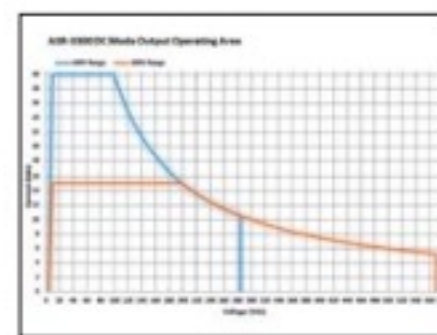

DC Output for ASR-3300

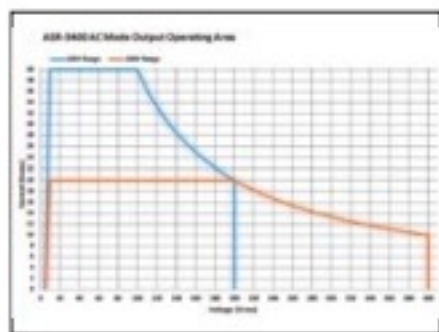

AC Output for ASR-3400

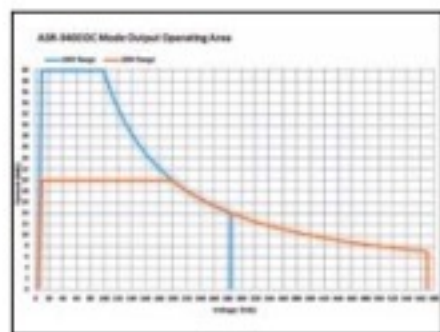

DC Output for ASR-3400

Model Name	Power Rating	Max. Output Current	Max. Output Voltage
ASR-3200	2k VA	20 / 10 A	400 Vrms / ± 570 Vdc
ASR-3300	3k VA	30 / 15 A	400 Vrms / ± 570 Vdc
ASR-3400	4k VA	40 / 20 A	400 Vrms / ± 570 Vdc

The ASR-3000 series is an AC + DC power source that provides not only rated power output for AC output, but also rated power output for DC output.

B. MEASUREMENT ITEMS FOR ASR-3000 SERIES



RMS Meas Display

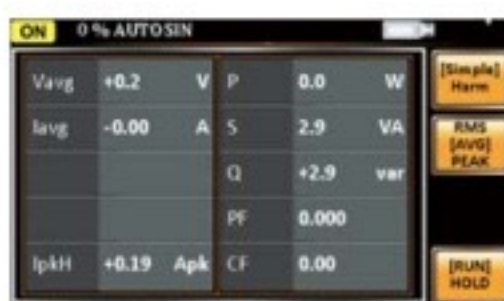

AVG Meas Display



Peak Meas Display

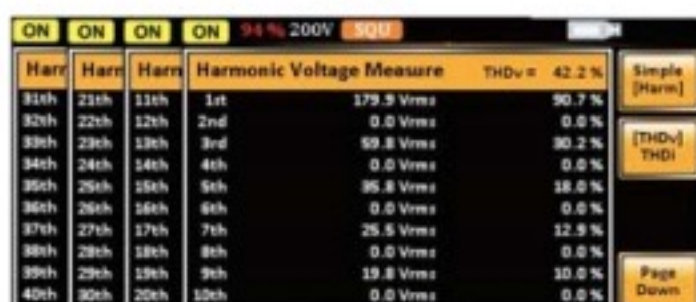

Voltage Harmonic

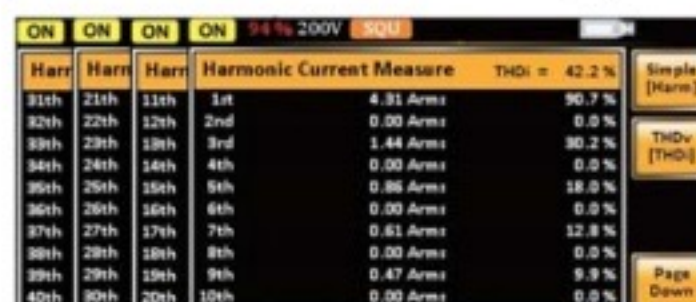

Current Harmonic

The ASR-3000 Series provides users with measurement capabilities including Vrms, Vavg, Vpeak, Irms, Iavg, Ipeak, IpH, P, S, Q, PF, CF, 100th-order Voltage Harmonic and Current Harmonic. During the power output, the measurement

parameters including Vrms/Irms, Vavg/Iavg and Vmax/Vmin/Imax/Imin can be switched by users at any time to display the instantaneous calculation reading.

C. SEQUENCE MODE AND BUILT-IN ISO-16750-2 WAVEFORMS



SEQ6: Momentary Drop in Supply Voltage

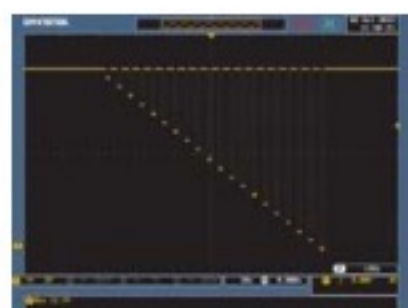

SEQ7: Reset Behavior at Voltage Drop with 12V System

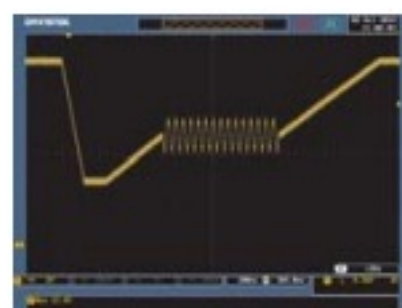

SEQ8: Starting Profile Waveform

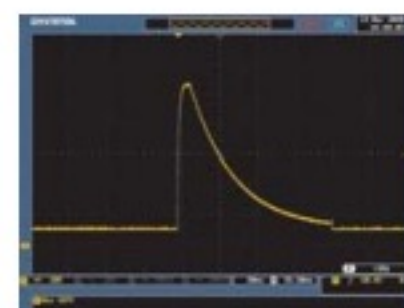

SEQ9: Load Dump with Tr_10ms, Td_40ms

The sequence mode provides editable 10 sets of SEQ0~SEQ9, each set has 0~999 steps, each step time setting range is 0.0001~999.9999 seconds. Users can combine multiple sets of steps to generate the required waveforms, including waveform falling, surges, sags and other abnormal power line conditions to meet the needs of the test applications.

In addition, ASR-3000 Series also built in common ISO-16750-2 test waveforms in the Sequence Mode preset waveforms, including Momentary Drop in Supply Voltage built in at SEQ6, Reset Behavior at Voltage Drop with 12V system built in at SEQ7, Starting Profile Waveform built in at SEQ8 and Load Dump with Tr_10ms, and Td_40ms built in at SEQ9.

Programmable AC/DC Power Source

D. SIMULATE MODE

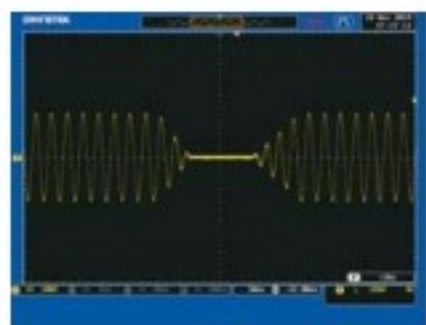

Power Outage

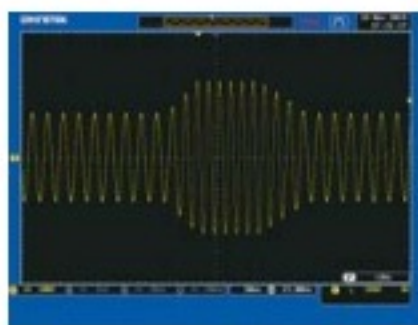

Voltage Rise

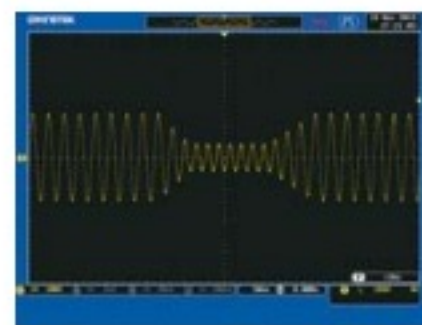

Voltage Fall

Simulate Mode can quickly simulate different transient waveforms, such as power outage, voltage rise, voltage fall, etc.,

for engineers to evaluate the impact of transient phenomena on the DUT. Ex: Capacitance durability test.

E. FUNCTION WAVEFORM (ARBITRARY EDIT) MODE



TRI Waveform



STAIR Waveform



CLIP Waveform



SURGE Waveform



Fourier Series Synthesized Waveform

ASR-3000 Series provides more than 20,000 waveform combinations in seven categories, allowing users to quickly simulate different AC voltage waveforms. Adjust the desired waveform type directly through the panel (displayed synchronously on the screen),

then the waveform is loaded into the ARB 1~16 waveform register through the access procedures, and return to the main menu output mode to perform ARB Waveform output.

F. PC SOFTWARE



Basic Controller

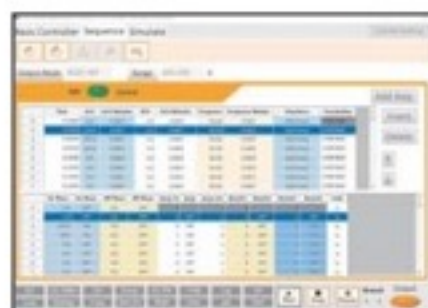

Sequence Mode

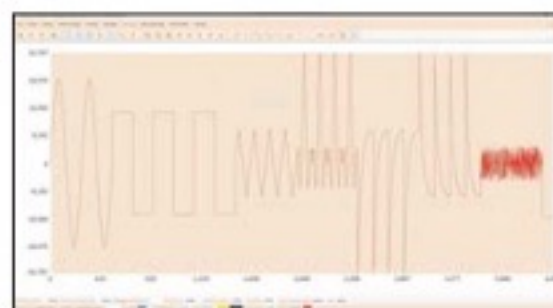

ARB Waveform Edit



The Waveform is Observed with DSO

The ASR-3000 Series software includes basic settings, the Simulate Mode, the Sequence Mode, Data Log and the arbitrary waveform editing function. Users can directly set output voltage, frequency, start/stop phase on ASR-3000 Series through the software. The Simulate Mode can quickly simulate different transient waveforms such as power outage, voltage rise, voltage fall... etc.

The Sequence Mode can edit the editing parameters read back from ASR-3000 Series, or directly edit the parameters and control ASR-3000 Series to output waveforms according to the set sequence.

The arbitrary waveform editing function not only combines various waveforms, including sine waves, square waves, triangle waves, and noise waveforms, but also allows users to draw arbitrary waveforms and output them.

G. T, IPK HOLD & IPK, HOLD FUNCTIONS

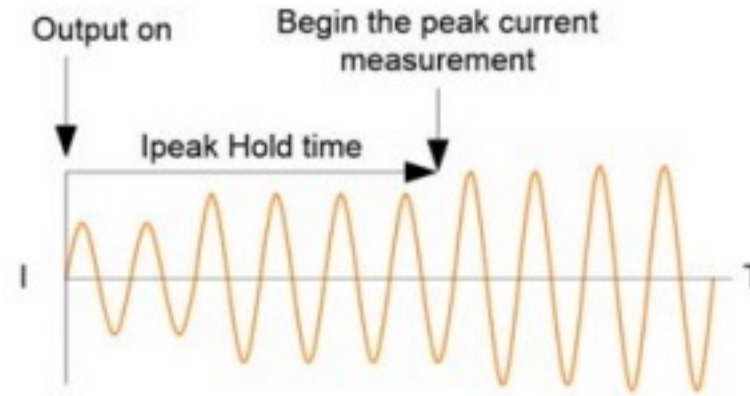

T, Ipk Measurement

T, Ipk Hold is used to set the delay time after the output (1ms ~ 60,000ms) to capture the Ipeak value and keep the maximum value. The update only functions when the measurement value is greater than the original value. The T, Ipk Hold delay time setting can be used to measure surge current at the power on process of the DUT.

Ipk Hold can be used to measure the transient surge current of the DUT at power on without using an oscilloscope and a current probe.

H. SLEW RATE MODE



The ASR-3000 Series can set the Slew Rate Mode to determine the rise time of the voltage according to the test requirements of the DUT. Slew Rate Mode provides "Time" and "Slope" modes. When setting "Time" mode, ASR-3000 Series can increase output to 10~90% of the set voltage within 100 μ s; and when selecting "Slope" mode, ASR-3000 Series increases output voltage by a fixed rising slope of 1.5V/ μ s until reaching the set voltage value.

In addition, if users decide to self-define the rise time of the output voltage, users can flexibly set the rise time of the ASR-3000 Series voltage by editing the Sequence mode.

Compact Programmable A.C./D.C. Power Source



ASR-2050/2100 Series



ASR-2050R/2100R Series



FEATURES

- Output Rating: AC 0 ~ 350 Vrms, DC 0 ~ ± 500 V
- Output Frequency up to 999.9 Hz
- DC Output (100% of Rated Power)
- Output Capacity: 500VA/1000VA
- Measurement Items: Vrms, Vavg, Vpeak, Irms, IpkH, Iavg, Ipeak, P, S, Q, PF, CF
- Voltage and Current Harmonic Analysis (THDv, THDi)
- Customized Phase Angle for Output On/Off
- Remote Sensing Capability
- OVP, OCP, OPP, OTP, AC Fail Detection and Fan Fail Alarm
- Interface: USB, LAN, RS-232(std.); GPIB(opt.)
- Built-in External Control I/O and External Signal Input
- Built-in Output Relay Control
- Memory Function (up to 10 sets)
- Sequence and Simulation Function (up to 10 sets)
- Support Arbitrary Waveform Function
- Built-in Web Server

GET-003 Universal Extended Terminal Box (ASR-2000R only)



GET-004 Euro Extended Terminal Box (ASR-2000R only)



The ASR-2000 series, an AC+DC power source aiming for system integration or desktop applications, provides both rated power output for AC output and rated power output for DC output. Ten ASR-2000 output modes are available, including 1) AC power output mode (AC-INT Mode), 2) DC power output mode (DC-INT Mode), 3) AC/DC power output mode (AC+DC-INT Mode), 4) External AC signal source mode (AC-EXT Mode), 5) External AC/DC signal source mode (AC+DC-EXT Mode), 6) External AC signal superimposition mode (AC-ADD Mode), 7) External AC/DC signal superimposition mode (AC+DC-ADD Mode), 8) External AC signal synchronization mode (AC-SYNC Mode), 9) External AC/DC signal synchronization mode (AC+DC-SYNC Mode), 10) External DC voltage control of AC output mode (AC-VCA).

The ASR-2000 series provides users with waveform output capabilities to meet the test requirements of different electronic component development, automotive electrical devices and home appliance, including 1) Sequence mode generates waveform fallings, surges, sags, changes and other abnormal power line conditions; 2) Arbitrary waveform function allows users to store/upload user-defined waveforms; and 3) Simulate mode simulates power outage, voltage rise, voltage fall, and frequency variations. When the ASR-2000 series power source outputs, it can also measure Vrms, Vavg, Vpeak, Irms, Iavg, Ipeak, IpkH, P, S, Q, PF, CF, 100th-order Voltage Harmonic and Current Harmonic. In addition, the Remote sense function ensures accurate voltage output. The Customized Phase Angle for Output On/Off function can set the starting angle and ending angle of the voltage output according to the test requirements. V-Limit, Ipeak-Limit, F-Limit, OVP, OCP, OPP function settings can protect the DUT during the measurement process. In addition to OTP, OCP, and OPP protection, the ASR-2000 series also incorporates the Fan fail alarm function and AC fail alarm function.

The front panel of the ASR-2050/2100 provides a universal socket or a European socket, which allows users to plug and use so as to save wiring time. The ASR-2050R/2100R is 3U height and 1/2 Rack width design, which is compatible with ATS assembly. The ASR-2000 series supports I/O interface and is equipped with USB, LAN, PS-232C External I/O and optional GPIB.

SPECIFICATIONS

		ASR-2050/ASR-2050R	ASR-2100/ASR-2100R
INPUT RATING (AC)			
NOMINAL INPUT VOLTAGE		100 Vac to 240 Vac	100 Vac to 240 Vac
INPUT VOLTAGE RANGE		90 Vac to 264 Vac	90 Vac to 264 Vac
PHASE		Single phase, Two-wire	Single phase, Two-wire
INPUT FREQUENCY RANGE		47 Hz to 63 Hz	47 Hz to 63 Hz
MAX. POWER CONSUMPTION		800 VA or less	1500 VA or less
POWER FACTOR ^{*1}	100Vac	0.95 (typ.)	0.95 (typ.)
	200Vac	0.90 (typ.)	0.90 (typ.)
MAX. INPUT CURRENT	100Vac	8 A	15 A
	200Vac	4 A	7.5 A
^{*1} . For an output voltage of 100 V/200 V (100V/200V range), maximum current, and a load power factor of 1.			
AC MODE OUTPUT RATINGS (AC rms)			
VOLTAGE	Setting Range ^{*1} Setting Resolution Accuracy ^{*2}	0.0 V to 175.0 V / 0.0 V to 350.0 V 0.1 V ±(0.5 % of set + 0.6 V / 1.2 V)	
OUTPUT PHASE		Single phase, Two-wire	
MAXIMUM CURRENT ^{*3}	100 V	5 A	10 A
	200 V	2.5 A	5 A
MAXIMUM PEAK CURRENT ^{*4}	100 V	20 A	40 A
	200 V	10 A	20 A
POWER CAPACITY		500 VA	1000 VA
FREQUENCY	Setting Range Setting Resolution Accuracy Stability ^{*5}	AC Mode: 40.00 Hz to 999.9 Hz, AC+DC Mode: 1.00 Hz to 999.9 Hz 0.01 Hz (1.00 to 99.99 Hz), 0.1 Hz (100.0 to 999.9 Hz) For 45 Hz to 65 Hz: 0.01% of set, For 40 Hz to 999.9 Hz: 0.02% of set ± 0.005%	
OUTPUT ON PHASE DC OFFSET ^{*6}		0.0° to 359.9° variable (setting resolution 0.1°) Within ± 20 mV (TYP)	
^{*1} . 100 V / 200 V range ^{*2} . For an output voltage of 17.5 V to 175 V / 35 V to 350 V, sine wave, an output frequency of 45 Hz to 65 Hz, no load, DC voltage setting 0V (AC+DC mode) and 23°C ± 5°C ^{*3} . For an output voltage of 1 V to 100 V / 2 V to 200 V, Limited by the power capacity when the output voltage is 100 V to 175 V / 200 V to 350 V. ^{*4} . With respect to the capacitor-input rectifying load. Limited by the maximum current. ^{*5} . For 45 Hz to 65 Hz, the rated output voltage, no load and the resistance load for the maximum current, and the operating temperature. ^{*6} . In the case of the AC mode and output voltage setting to 0 V.			
OUTPUT RATING FOR DC MODE			
VOLTAGE	Setting Range ^{*1} Setting Resolution Accuracy ^{*2}	-250 V to +250 V / -500 V to +500 V 0.1 V ±(0.5 % of set + 0.6 V / 1.2 V)	
MAXIMUM CURRENT ^{*3}	100 V	5 A	10 A
	200 V	2.5 A	5 A
MAXIMUM PEAK CURRENT ^{*4}	100 V	20 A	40 A
	200 V	10 A	20 A
POWER CAPACITY		500 W	1000 W
^{*1} . 100 V / 200 V range ^{*2} . For an output voltage of -250 V to -25 V, +25 V to +250 V / -500 V to -50 V, +50 V to +500 V, no load, AC voltage setting 0V (AC+DC mode) and 23°C ± 5°C ^{*3} . For an output voltage of 1.4 V to 100 V / 2.8 V to 200 V, Limited by the power capacity when the output voltage is 100 V to 250 V / 200 V to 500 V. ^{*4} . Within 5 ms, Limited by the maximum current.			
OUTPUT VOLTAGE STABILITY			
LINE REGULATION ^{*1}		±0.2% or less	
LOAD REGULATION ^{*2}		±0.15% @45-65Hz; ±0.5% @DC, all other frequencies (0-100%, via output terminal)	
RIPPLE NOISE ^{*3}		0.7 Vrms / 1.4 Vrms (TYP)	
^{*1} . Power source input voltage is 100 V, 120 V, or 230 V, no load, rated output. ^{*2} . For an output voltage of 75 V to 175V/150V to 350V, a load power factor of 1, stepwise change from an output current of 0 A to maximum current (or its reverse), using the output terminal on the rear panel. ^{*3} . For 5 Hz to 1 MHz components in DC mode using the output terminal on the rear panel.			
OUTPUT VOLTAGE WAVEFORM DISTORTION RATIO, OUTPUT VOLTAGE RESPONSE TIME, EFFICIENCY			
TOTAL HARMONIC DISTORTION(THD) ^{*1}		≤ 0.2% @50/60Hz, ≤ 0.3% @<500Hz, ≤ 0.5% @500.1Hz~999.9Hz	
OUTPUT VOLTAGE RESPONSE TIME ^{*2}		100 μs (TYP)	
EFFICIENCY ^{*3}		70 % or more	
^{*1} . At an output voltage of 50 V to 175 V / 100 V to 350 V, a load power factor of 1, and in AC and AC+DC mode. ^{*2} . For an output voltage of 100 V / 200 V, a load power factor of 1, with respect to stepwise change from an output current of 0 A to the maximum current (or its reverse); 10% - 90% of output voltage ^{*3} . For AC mode, at an output voltage of 100 V / 200 V, maximum current, and load power factor of 1 and sine wave only.			
MEASURED VALUE DISPLAY			
VOLTAGE RMS, AVG Value ^{*1}	Resolution Accuracy ^{*2}	0.1 V For 45 Hz to 65 Hz and DC: ±(0.5 % of reading + 0.3 V/0.6 V) For 40 Hz to 999.9 Hz: ±(0.7 % of reading + 0.9 V/1.8 V)	
PEAK Value	Resolution Accuracy	0.1 V For 45 Hz to 65 Hz and DC: ±(2 % of reading + 1 V / 2 V)	
CURRENT RMS, AVG Value	Resolution Accuracy ^{*3}	0.01 A For 45 Hz to 65 Hz and DC: ±(0.5 % of reading+0.02 A/0.02 A); For 40 Hz to 999.9 Hz: ±(0.7 % of reading + 0.04 A / 0.04 A)	
		0.01 A For 45 Hz to 65 Hz and DC: ±(0.5 % of reading+0.04 A/0.02 A); For 40 Hz to 999.9 Hz: ±(0.7 % of reading + 0.08 A / 0.04 A)	



ASR-2000 Series

SPECIFICATIONS		ASR-2050/ASR-2050R	ASR-2100/ASR-2100R
POWER	PEAK Value	Resolution Accuracy ^{*1}	0.01 A For 45 Hz to 65 Hz and DC: ±(2 % of reading)+0.2 A/0.1 A)
	Active (W)	Resolution Accuracy ^{*2}	0.1 / 1 W ±(2 % of reading + 0.5 W)
	Apparent (VA)	Resolution Accuracy ^{*4}	0.1 / 1 VA ±(2 % of reading + 0.5 VA)
LOAD POWER FACTOR	Reactive (VAR)	Resolution Accuracy ^{*7}	0.1 / 1 VAR ±(2 % of reading + 0.5 VAR)
	Range	Resolution	0.000 to 1.000 0.001
LOAD CREST FACTOR	Range	Resolution	0.00 to 50.00 0.01
	Resolution	Resolution	0.01
HARMONIC VOLTAGE EFFECTIVE VALUE (RMS) PERCENT (%) (AC-INT and 50/60 Hz only)	Range	Resolution	Up to 100th order of the fundamental wave 175 V / 350 V, 100% 0.1 V, 0.1%
	Full Scale	Accuracy ^{*3}	Up to 20th±(0.2% of reading + 0.5V/1V); 20th to 100th±(0.3% of reading + 0.5V/1V)
HARMONIC CURRENT EFFECTIVE VALUE (RMS) PERCENT (%) (AC-INT and 50/60 Hz only)	Range	Resolution	Up to 100th order of the fundamental wave 5 A / 2.5 A, 100% 0.01 A, 0.1%
	Full Scale	Accuracy ^{*3}	Up to 20th±(1% of reading + 0.1A/0.05A); 20th to 100th±(1.5% of reading + 0.2A/0.1A)
<p>*1. The voltage display is set to RMS in AC/AC+DC mode and AVG in DC mode. *2. AC mode: For an output voltage of 17.5V to 175V/35V to 350V and 23 °C±5 °C. DC mode: For an output voltage of 25V to 250V/50V to 500V and 23 °C±5 °C. *3. An output current in the range of 5 % to 100 % of the maximum current, and 23 °C ± 5 °C. *4. An output current in the range of 5 % to 100 % of the maximum peak current in AC mode, an output current in the range of 5 % to 100 % of the maximum instantaneous current in DC mode, and 23 °C ± 5 °C. The accuracy of the peak value is for a waveform of DC or sine wave. *5. For an output voltage of 50V or greater, an output current in the range of 10 % to 100 % of the maximum current, DC or an output frequency of 45Hz to 65Hz, and 23 °C±5 °C. *6. The apparent and reactive powers are not displayed in the DC mode. *7. The reactive power is for the load with the power factor 0.5 or lower. *8. An output voltage in the range of 17.5 V to 175 V/35 V to 350 V and 23 °C ± 5 °C.</p>			
OTHERS			
PROTECTIONS		OCP, OTP, OPP, FAN Fail	
DISPLAY		TFT-LCD, 4.3 inch	
MEMORY FUNCTION		10 sets for Store and Recall settings	
ARBITRARY WAVE	Number of Memories	16 (nonvolatile)	
	Waveform Length	4096 words	
INTERFACE	Standard	USB LAN	
	Optional	RS-232C EXT Control GPIB	
INSULATION RESISTANCE		500 Vdc, 30 MΩ or more	
WITHSTAND VOLTAGE		1500 Vac, 1 minute	
EMC		EN 61326-1 (Class A); EN 61326-2-1/-2-2 (Class A); EN 61000-3-2 (Class A, Group 1); EN 61000-3-3 (Class A, Group 1); EN 61000-4-2/-4-3/-4-4/-4-5/-4-6/-4-8/-4-11 (Class A, Group 1); EN 55011 (Class A, Group 1); EN 61010-1 Indoor use, Overvoltage Category II	
Safety Environment	Operating Environment	0 °C to 40 °C	
	Operating Temperature Range	-10 °C to 70 °C	
	Storage Temperature Range	20 % RH to 80 % RH (no condensation)	
	Operating Humidity Range	90 % RH or less (no condensation)	
	Storage Humidity Range	Up to 2000 m	
DIMENSIONS & WEIGHT		ASR-2000 : 285(W)×124(H)×480(D) (not including protrusions); Approx. 11.5 kg ASR-2000R : 213(W)×124(H)×480(D) (not including protrusions); Approx. 10.5 kg	

ORDERING INFORMATION

ASR-2050 500VA Programmable AC/DC Power Source
 ASR-2100 1000VA Programmable AC/DC Power Source
 ASR-2050R 500VA Programmable AC/DC Power Source for 3U 1/2 Rack Mount
 ASR-2100R 1000VA Programmable AC/DC Power Source for 3U 1/2 Rack Mount

ACCESSORIES :

CD ROM (User Manual, Programming manual), Safety Guide, Power Cord, Mains Terminal Cover Set, Remote Sense Terminal Cover Set, GTL-123 Test Lead, GTL-246 USB Cable

OPTIONAL ACCESSORIES

ASR-GPIB-2K Optional GPIB Interface for ASR-2000 (Factory installed)
 ASR-EU-2K European Output Outlet only for ASR-2000 (Factory installed)
 GET-003 Extended Universal Power Socket (ASR-2000R only)
 GET-004 Extended European Power Socket (ASR-2000R only)
 ASR-001 Air inlet filter
 ASR-002 External three phase control unit for 1P2W, 1P3W, 3P4W output

GRA-439-E Rack Mount Kit (EIA)
 GRA-439-J Rack Mount Kit (JIS)
 GTL-232 RS-232C Cable, approx. 2M
 GTL-258 GPIB Cable, approx. 2M, including 25 pins Micro-D connector

FREE DOWNLOAD

USB Driver

Note : GET-003/GET-004 are not CE approved.

ASR-2050/2100 Rear Panel



ASR-2050R/2100R Rear Panel



GRA-439-J/E Rack Mount Kit (JIS/EIA)

For : ASR-2000 Series



GTL-258 GPIB Cable, 2000mm



ASR-001 Air Inlet Filter



ASR-002 External three phase control unit

* Basis Requirement of ASR-002 to ASR-Series

1. Must be the three same models of ASR-Series
2. To ASR-2000 Series, the ASR-GPIB-2K: GPIB interface is required

* Functions of ASR-Series are limited when conducts to ASR-002

1. No DC Output
2. Measurement Items: only current (A), power (W) and PF for each phase
3. No Voltage and Current Harmonic Analysis
4. No Remote Sensing Capability
5. No Arbitrary Waveform Function
6. No Sequence and Simulation Function
7. Not supported External Control I/O
8. No memory Function
9. Only support USB, no LAN port for communication

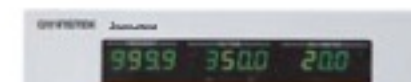

Compact Programmable A.C./D.C. Power Source

A. OPERATING AREA FOR ASR-2000 SERIES

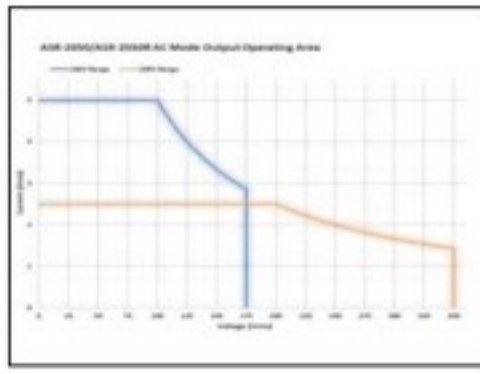

AC Output for ASR-2050/ASR-2050R

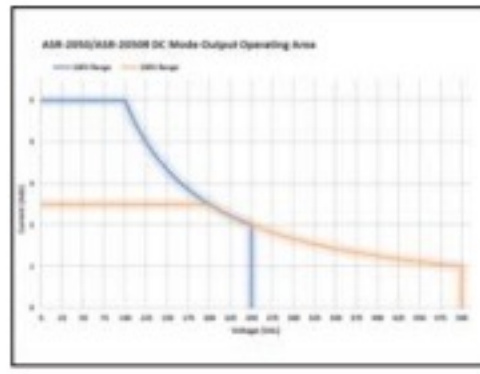

DC Output for ASR-2050/ASR-2050R

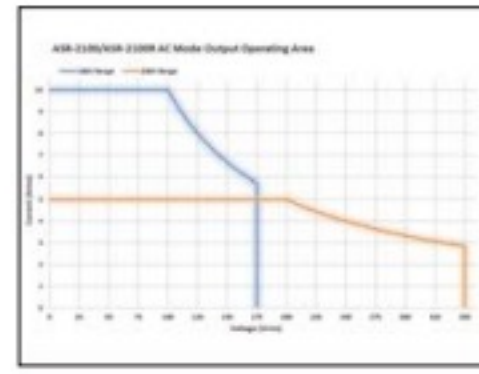

AC Output for ASR-2100/ASR-2100R

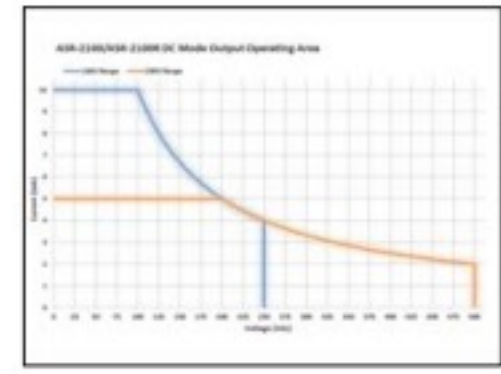

DC Output for ASR-2100/ASR-2100R

The ASR-2000 series is an AC+DC power source that provides rated power output not only at the AC output, but also at the DC output. The operation areas are shown in diagrams.

Model Name	Power Rating	Max. Output Current	Max. Output Voltage
ASR-2050	500 VA	5 / 2.5 A	350 Vrms / 500 Vdc
ASR-2100	1000 VA	10 / 5 A	350 Vrms / 500 Vdc
ASR-2050R	500 VA	5 / 2.5 A	350 Vrms / 500 Vdc
ASR-2100R	1000 VA	10 / 5 A	350 Vrms / 500 Vdc

B. MEASUREMENT ITEMS FOR ASR-2000 SERIES



RMS Meas Display



AVG Meas Display



Peak Meas Display

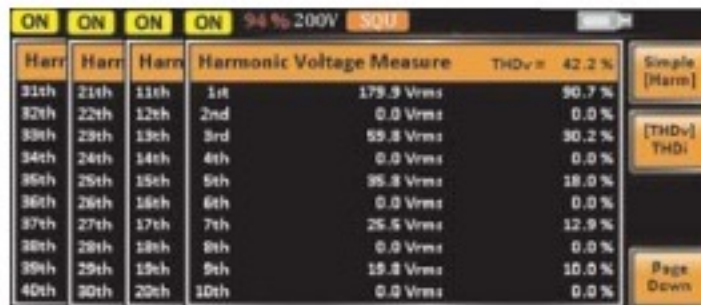

Voltage Harmonic

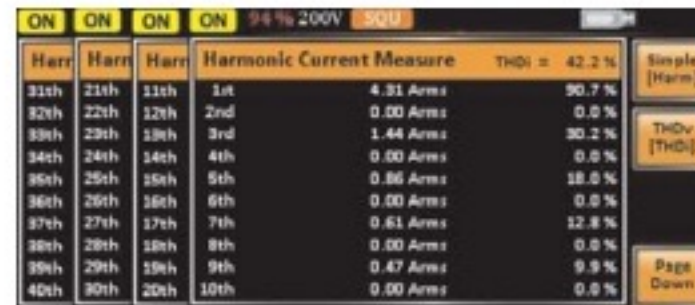

Current Harmonic

The ASR-2000 series provides users with measurement capabilities including Vrms, Vavg, Vpeak, Irms, Iavg, Ipeak, IpkH, P, S, Q, PF, CF, 40th-order Voltage Harmonic and Current Harmonic. During the power output, the measurement

parameters including Vrms/Irms, Vavg/Iavg and Vmax/Vmin/Imax/Imin can be switched by users at any time to display the instantaneous calculation reading.

C. SEQUENCE MODE AND APPLICATIONS

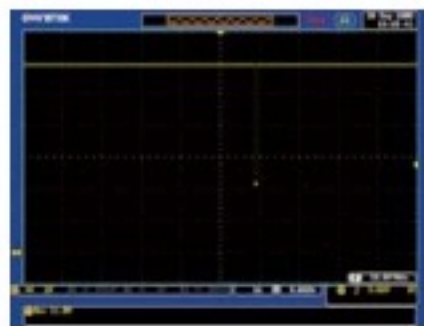

Momentary Drop in Supply Voltage

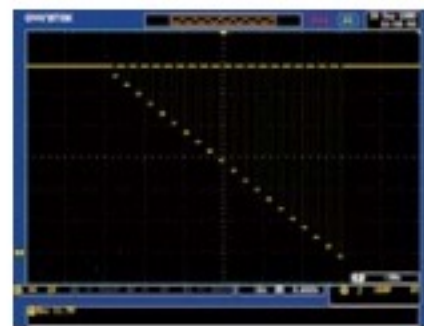

Reset Behavior at Voltage Drop

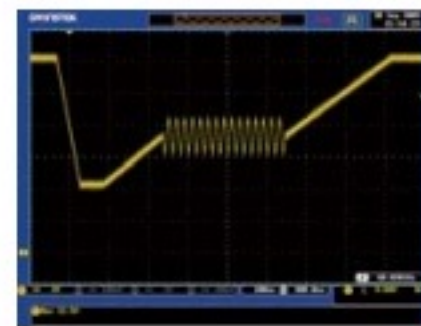

Starting Profile Waveform

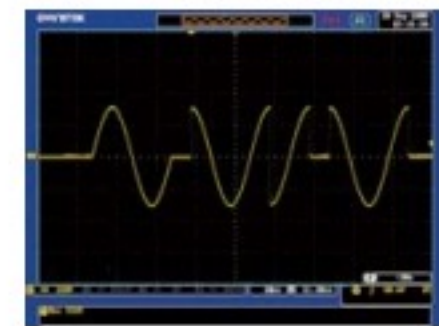

Instantaneous Power Failure

There are 10 sets of Sequence mode and each set has 0~999 steps. The time setting range of each step is 0.0001 ~ 999.9999 seconds. Users can combine multiple sets of steps to generate

the desired waveforms, including waveform fallings, surges, sags, changes and other abnormal power line conditions to meet the needs of the test application.

D. SIMULATE MODE

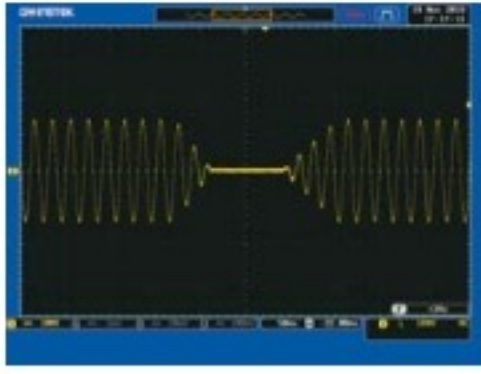

Power Outage

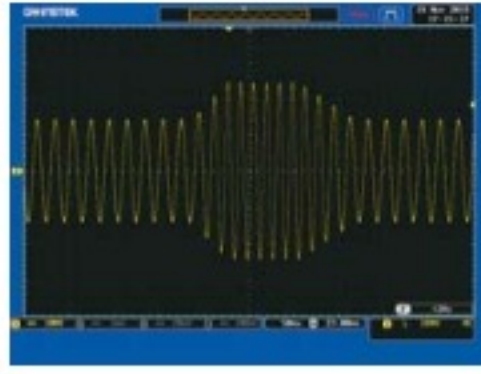

Voltage Rise

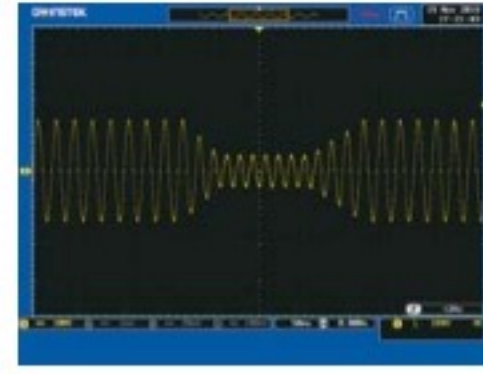

Voltage Fall

Simulate Mode can quickly simulate different transient waveforms, such as power outage, voltage rise, voltage fall, etc.,

for engineers to evaluate the impact of transient phenomena on the DUT. Ex: Capacitance durability test.

E. T, IPK HOLD & IPK, HOLD FUNCTIONS

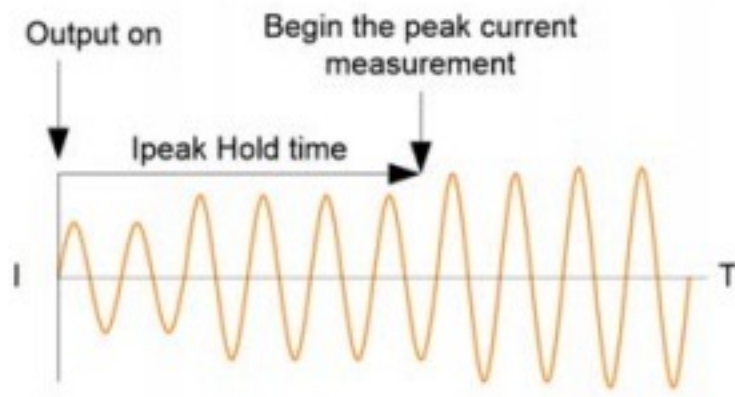

T, Ipk Measurement

T, Ipk Hold is used to set the delay time after the output (1ms ~ 60,000ms) to capture the Ipeak value and keep the maximum value. The update only functions when the measurement value is greater than the original value. The T, Ipk Hold delay time setting can be used to measure surge current at the power on process of the DUT.

Ipk Hold can be used to measure the transient surge current of the DUT at power on without using an oscilloscope and a current probe.

F. SLEW RATE MODE



Time Mode

Slope Mode

The ASR-2000 series can set the Slew Rate Mode to determine the rise time of the voltage according to the test requirements of the DUT. Slew Rate Mode provides "Time" and "Slope" modes. When setting "Time" mode, ASR-2000 can increase output to 10~90% of the set voltage within 100 μ s; and when selecting "Slope" mode, ASR-2000 increases output voltage by a fixed rising slope of 1.5V/ μ s until reaching the set voltage value.

In addition, if users decide to self-define the rise time of the output voltage, users can flexibly set the rise time of the ASR-2000 series voltage by editing the Sequence mode.

G. REMOTE SENSE FUNCTION

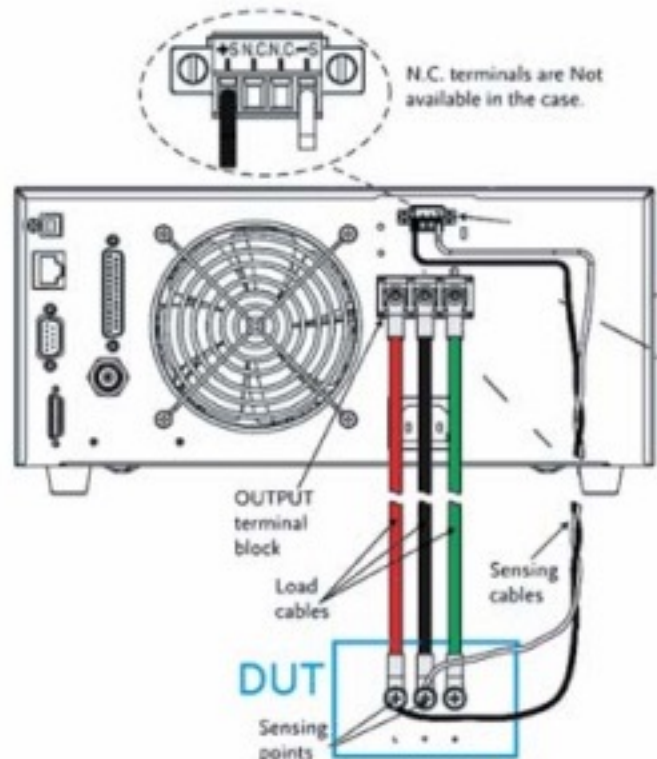

For high current output applications, the voltage drop caused by large current passing through the load cables will affect the measurement results. The ASR-2000 series provides the remote sense function that can sense the voltage drop of the DUT to the ASR-2000 series and the DUT will be compensated by the ASR-2000 series. The maximum voltage that the remote sense function can compensate is 5% of the output voltage.

500/1000/2000/3000 VA Programmable Linear AC Power Source



APS-7050



APS-7100



FEATURES

- * 4.3-inch TFT-LCD
- * Output Capacity: APS-7050(500VA,310Vrms,4.2Arms); APS-7100(1000VA,310Vrms,8.4Arms); APS-7200(2000VA,310Vrms,16.8Arms); APS-7300(3000VA,310Vrms,25.2Arms)
- * Output Augmentation by Options(0-600Vrms/45-999.9Hz)
- * Low Ripple & Noise
- * Measurement and Test Functions Include VOLT, CURR, PWR, SVA, IPK, IPKH, FREQ, PF, CF
- * Support a Small AC Current Measurement 2mA -35A, Min. Resolution 0.01mA(APS-7050&APS-7100)
- * Reverse Current Alarm Function
- * 10 sets of Sequence Function to Edit Output Waveforms/10 sets of Simulate Mode to Rapidly Simulate Transient Power Supply/10 sets of Program Mode to Define Measurement Sequence/10 sets of Panel Memory Function
- * Automatic Execution of Sequence, Simulate, Program mode and Output Function when the Power is on
- * Standard Interfaces:USB Host,USB Device,LAN
- * Optional Interfaces:GPIB(APS-001);RS-232/USB CDC(APS-002 for APS-7050&APS-7100 only)RS-232(APS-007 for APS-7200& APS-7300 only)

APS-001/APS-002 Interface Card



APS-003

Output Voltage Capacity

APS-004

Output Frequency Capacity



APS-007 RS-232 Interface Card

For: APS-7200 Series, APS-7300 Series



GWInstek introduces APS-7000 series programmable AC power sources, which consists of 500VA of APS-7050, 1000VA of APS-7100, 2000VA of APS-7200 and 3000VA of APS-7300. APS-7000 series features power characteristics from its linear structure design including low noise, low THD, and highly stabilized power output that are ideal for the product development and verification of input power with low noise requirement or stereo, video and audio device applications, etc. The maximum rated voltage is 0-310Vrms, 25.2Arms, 100.8A peak current and the output frequency range is 45-500.0Hz. Users can conveniently augment the output voltage from 0Vrms to 600Vrms and output frequency from 45Hz to 999.9Hz by purchasing options without sending equipment back to GW Instek.

One of the popular alternative energy solutions in the market is to utilize inverter to convert DC to AC and the converted AC is then sent to power grid or products require electricity. For instance, AC produced by PV inverter is sent to power grid or equipment requires electricity. While simulating power grid to verify inverter connecting with power grid, general AC power sources cannot withstand DUT's feedback energy, hence, additional power consumption resistors are needed to prevent AC power source from being damaged. On the contrary, APS-7000 series has the characteristic of absorbing reverse current so that additional power consumption resistors are not required. The input terminal of APS-7000 series is designed to isolate from the simulated AC power grid output terminal, therefore, users do not need an additional isolation device to protect DUT. APS-7000 series is suitable for simulating power grid and conducting inverter output characteristic tests, including synchronized phase and frequency. Reverse current and power detected by APS-7000 series will be displayed in red readings to facilitate user's test observation. APS-7000 series utilizes Simulate mode and Sequence mode to provide a single step or consecutive power changes; and to simulate power grid's Voltage Abnormality Test and Frequency Abnormality Test.

APS-7000 series comprises nine measurement and test functions (Vrms, Irms, F, Ipk, W, VA, PF, Ipk hold, CF), and provides user interface similar to that of AC Power Meter. APS-7000 series is ideal for the LED industry and standby mode power consumption test. Under the ARB mode, APS-7000 series provides waveforms in seven categories including Sine waveform, Triangle waveform, Staircase waveform (Square wave), Clipped Sinewave, Crest factor waveform, Surge waveform, and Fourier series and 20,000 waveform combinations so as to meet the requirements of simulating abnormal input power waveform test of various industries. Ten Preset settings allow users to store ten sets of data; Power ON Output setting allows Sequence, Simulate, and Program to automatically execute output after the equipment power is on.

To meet the test criteria of line voltage fluctuation often seen in consumer electronics, APS-7000 series features five methods to cope with special purpose or abnormal voltage, frequency, and phase; ten sets of the Simulate mode simulate power outage, voltage rise, and voltage fall; ten sets of the Sequence mode allow users to define parameters and produce sine wave by editing steps; ten sets of the Program mode can edit AC waveform output and define the ceiling and floor level of measurement items for different DUTs; Ramp Control allows users to set the variation speed for output voltage rise and fall; Surge/Dip Control simulates DUT's input power producing a Surge or Dip voltage overlapping with output voltage waveform at a specific time. For larger current output applications, voltage drop across the output cables should be avoided. APS-7200/7300 also provide the remote sense function, which senses DUT's voltage and sends the information back to APS-7200/7300 for program controlled voltage compensation. Therefore, APS-7200/7300 can avoid the voltage drop of the cable to affect output voltage.

Ethernet Port, on the rear panel, can be used for remote program control; Sync Output Socket provides external 10V sync output; Signal Output Connector provides monitor of Program execution results. APS-7000 series also provides users with Trigger In/Out and Output on/off remote control functions from J1 connector on the rear panel.

SPECIFICATIONS				
Model	APS-7050	APS-7100	APS-7200	APS-7300
AC OUTPUT				
Power Rating	500VA	1000VA	2000VA	3000VA
Output Voltage	0 - 155Vrms, 0 - 310Vrms	0 - 155Vrms, 0 - 310Vrms	0 - 155Vrms, 0 - 310Vrms	0 - 155Vrms, 0 - 310Vrms
Output Frequency	45.00 - 500.0 Hz	45.00 - 500.0 Hz	45.00 - 500.0 Hz	45.00 - 500.0 Hz
Maximum Current(r.m.s) *1	0-155Vrms 4.2A	0-310Vrms 8.4A	0-155Vrms 16.8A	0-310Vrms 25.2A
Maximum Current(peak)	0-155Vrms 16.8A	0-310Vrms 33.6A	0-155Vrms 67.2A	0-310Vrms 100.8A
OPT. APS-003(rms)	0-600Vrms 1.05A	0-600Vrms 2.1A	0-600Vrms 4.2A	0-600Vrms 6.3A
OPT. APS-003(peak)	0-600Vrms 4.2A	0-600Vrms 8.4A	0-600Vrms 16.8A	0-600Vrms 25.2A
Total Harmonic Distortion (THD)*2	≤ 0.5% at 45 - 500Hz (Resistive Load)			
Crest Factor	≤ 4			
Line Regulation	0.1% (% of full scale)			
Load Regulation	0.3% (% of full scale)			
Response Time	<100μs			
Reverse Current	30% of Maximum Output RMS Current (Continue); 100% of Maximum Output RMS Current (Within 3 minutes)			
SETTING				
Voltage	Range	0-155Vrms, 0-310Vrms, Auto		
	Resolution	0.01V at 0.00 - 99.99Vrms; 0.1V at 100.0 - 310.0Vrms		
	Accuracy	±(0.5% of setting+2 counts)		
Frequency	Range	45 - 500Hz		
	Resolution	0.01Hz at 45.00 - 99.99Hz; 0.1Hz at 100.0 - 500.0Hz		
	Accuracy	±0.02% of setting		
OPT. APS-004	Range	45-999.9Hz		
	Resolution	0.01Hz at 45.00 - 99.99Hz; 0.1Hz at 100.0 - 999.9Hz		
Power On/Off	Range	0 - 359°		
Phase Angle	Resolution	1°		
	Accuracy	±1°(45 - 65Hz)		
MEASUREMENT*3				
Voltage(RMS)	Range	0.20-38.75Vrms;38.76-77.50Vrms; 77.51-155.0Vrms;155.1-310.0Vrms		0.20-38.75Vrms;38.76-77.50Vrms; 77.51-155.0Vrms;155.1-310.0Vrms
	Resolution	0.01V at 0.00 - 99.99Vrms; 0.1V at 100.0 - 310.0Vrms		0.01V at 0.00 - 99.99Vrms; 0.1V at 100.0 - 310.0Vrms
Frequency	Accuracy*4	±(0.5% of reading + 2 counts)		±(0.5% of reading + 2 counts)
	Range	45 - 500Hz		45 - 500Hz
	Resolution	0.01Hz at 45Hz-99.99Hz; 0.1Hz at 100Hz-500.0Hz		0.01Hz at 45Hz-99.99Hz; 0.1Hz at 100Hz-500.0Hz
Current(RMS)	Accuracy	±0.1Hz		±0.1Hz
	Range	2.00 - 70.00mA;60.0 - 350.0mA; 0.300 - 3.500A;3.00 - 17.5A		0.200 - 3.500A;3.00-35.00A
	Resolution	0.01mA, 0.1mA, 0.001A, 0.01A		0.001A;0.01A
	Accuracy	±(0.6% of reading+5 counts),2.00-350.0mA; ±(0.5% of reading+5 counts),0.300-3.500A; ±(0.5% of reading+3 counts),3.000-17.50A		±(0.5% of reading+5 counts),0.200-3.500A ±(0.5% of reading+3 counts),3.00-35.00A



APS-7200

APS-7300

SPECIFICATIONS					
Model		APS-7050	APS-7100	APS-7200	APS-7300
Current(Peak)	Range	0.0 – 70.0A		0.0 – 140.0A	
	Resolution	0.1A		0.1A	
	Accuracy	±(1% of reading+1 count)		± 1% of reading+1 count)	
Power(W)	Resolution	0.01W, 0.1W, 1W		0.1W, 1W	
	Accuracy	±(0.6% of reading+5 counts),0.20–99.99W; ±(0.6% of reading+5 counts),100.0–999.9W; ±(0.6% of reading+2 counts),1000–9999W		±(0.6% of reading+5counts),0.2–999.9W; ±(0.6% of reading+2counts),1000–9999W	
	Resolution	0.01VA, 0.1VA, 1VA		0.1VA, 1VA	
Apparent(VA)	Accuracy	±(1% of reading+7 counts),0.20–99.99VA; ±(1% of reading+7 counts),100.0–999.9VA; ±(1% of reading+5 counts),1000–9999VA		±(1% of reading+7 counts),0.2–999.9VA; ±(1% of reading+5 counts),1000–9999VA	
	Resolution	0.001		0.001	
	Accuracy	±(2% of reading + 2 counts)		±(2% of reading+2 counts)	
GENERAL					
Remote output signal		Pass, Fail, Test-in Process, Trigger in, Trigger out, OUT ON/OFF			
Sync output signal		Output Signal 10 V, BNC Type			
Number of Preset		10 (0–9 numeric keys)			
Protection		OCP, OPP, OTP and Alarm			
Trigger Out		Maximum low level output = 0.8V ; Minimum high level output = 2V ; Maximum source current = 8mA			
Trigger In		Maximum low level input voltage = 0.8V ; Minimum high level input voltage = 2.0V; Maximum sink current = 8mA			
SEQUENCE/SIMULATION FUNCTION					
Number of Memories		10 (0 – 9 Numeric keys)			
Number of Steps		255 max. (For 1 sequence)			
Step Time Setting Range		0.01 – 999.99s			
Operation Within Step Parameters		Constant, Keep, Linear Sweep Output Range, Frequency, Waveform (sine wave only); On Phase, Off Phase, Term Jump Count (0 – 255) jump-to, Branch 1, Branch 2, Trigger Output			
Sequence Control		Start, Stop, Hold, Continue, Branch 1, Branch 2			
AC INPUT					
Phase	Single Phase	Single Phase	Single Phase	Single Phase	Single Phase
Input Voltage	115/230Vac±15%	115/230Vac±15%	230Vac±15%	230Vac±15%	230Vac±15%
Input Frequency	50/60Hz	50/60Hz	50/60Hz	50/60Hz	50/60Hz
Max. Current	16A/8A	32A/16A	32A	50A	50A
Power Factor	0.7Typ.	0.7Typ.	0.7Typ.	0.7Typ.	0.7Typ.
Power Consumption	1.8kVA or less	3.6kVA or less	7.2kVA or less	10.8kVA or less	10.8kVA or less
ENVIRONMENT CONDITIONS					
Operating Temperature Range		0 – +40°C			
Storage Temperature Range		-10 – +70°C			
Operating Humidity Range		20 – 80% RH (No Condensation)			
Storage Humidity Range		80% RH or less(No Condensation)			
INTERFACE					
Standard		USB Host, LAN		USB Host, USB CDC, LAN	
Optional		GPIB (APS-001) RS232 / USB CDC (APS-002)		GPIB (APS-001) RS232 (APS-007)	
DIMENSIONS & WEIGHT					
	430(W) x 88(H) x 400(D) mm; Approx. 24kg	430(W) x 88(H) x 560(D) mm; Approx. 38kg	430(W) x 312(H) x 650(D) mm; Approx. 90kg	430(W) x 400(H) x 650(D) mm; Approx. 128kg	

ORDERING INFORMATION

APS-7050 500VA Programmable AC Power Source APS-7200 2000VA Programmable AC Power Source
 APS-7100 1000VA Programmable AC Power Source APS-7300 3000VA Programmable AC Power Source

ACCESSORIES :

CD ROM(User Manual, Programming Manual for APS-7000) x 1, Power Cord(Region Dependent), GTL-123 Test Lead

OPTIONAL ASSESSORIES

APS-001 GPIB interface card APS-004 Output Frequency Capacity(45–999.9Hz)
 APS-002 RS-232/USB interface card(APS-7050, APS-7100) GRA-423 APS-7050, APS-7100 rack mount kit
 APS-007 RS-232 interface card(APS-7200, APS-7300) GRA-429 Rack mount kit (APS-7200)
 APS-003 Output Voltage Capacity(0–600Vrms) GRA-430 Rack mount kit (APS-7300)

Note : 1. APS-7200/APS-7300 are not CE approved.

2. The minimum time settings of sequence mode or simulate mode must be greater than 1 cycle of the waveform itself.

APS-7300 Rear Panel



APS-7200 Rear Panel



APS-7100 Rear Panel



APS-7050 Rear Panel



APS-7000 Series Europe Type Output Outlet



Note :

The Specifications are not suit for ARB mode.

*1. Maximum output current at working voltage 120Vrms, 240Vrms

*2. 45–500Hz, 10% or higher of the rated output voltage, the maximum current or lower

*3. All of measurement accuracy is at 23±5°C

*4. In the case of 15–155V, 30–310V, sine wave, no load

Mains Terminal Cover Set

For: APS-7100/7100E Series



For: APS-7050/7050E Series



500/1000/2000/3000 VA Programmable Linear AC Power Source

APS-7000 Series

POWER SOURCES

A. CONTROL PANEL CHARACTERISTICS



Standard Mode

Simple Mode

There are two control panel modes: Standard mode and Simple mode. Both modes are shown on the above. Standard mode combines settings and AC Power Meter measurement window display. Users apply Function key (F1~F3) to select required measurement items. There are nine items for selection. Simple mode shows all measurement items on the display.

B. REVERSE CURRENT DISPLAY



Standard Mode

Simple Mode

When output terminal detects 180 degree phase difference between voltage and current (reverse current), the front panel of APS-7000 Series will remind users the power and power factor measurement results in red numerical display. This feature can be applied to show the power and power factor measurement while testing inverter for feedback power grid. As shown on the above : APS-7000 Series can withstand reverse current: 30% of the maximum effective current or maximum current output within three minutes.

C. T IPEAK, HOLD FUNCTION

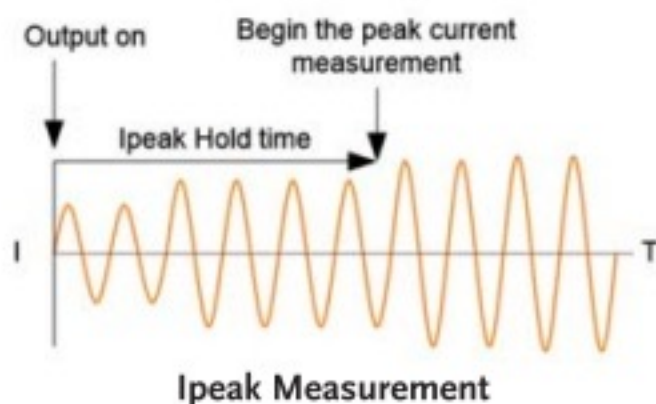

Ipeak Measurement

T, Ipk Hold sets delay time (1ms~60 seconds) for measurement after the output of Ipeak value and the maximum value will be retrieved. Update will be proceeded only if measured value is greater than the original value. Ipk Hold is for measuring transient inrush current as soon as the equipment power is on that is usually done by oscilloscope and current probe. T, Ipk Hold delay time setting can be applied to measure inrush current of sequentially activated DUT.

D. SEQUENCE MODE

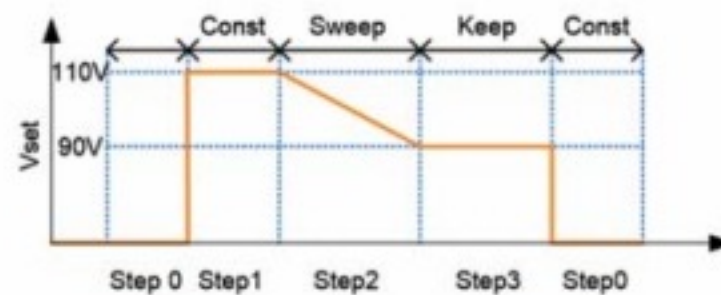

Sequence Mode

There are ten sets of Sequence mode and each set has 0~255 steps. The time setting range for each step is 0.01 ~ 999.99 seconds. Combining many sets of steps to edit required waveforms can satisfy users' requirement of highly complicated waveforms.

E. SIMULATE MODE



Power Outage



Voltage Rise



Voltage Fall

This mode can rapidly produce different simulated input transient waveforms such as power outage; voltage rise and voltage fall etc. for engineers to evaluate the impact on DUT posed by the transient phenomena. For instance, capacitor endurance test.

F. PROGRAM MODE

Program Mode

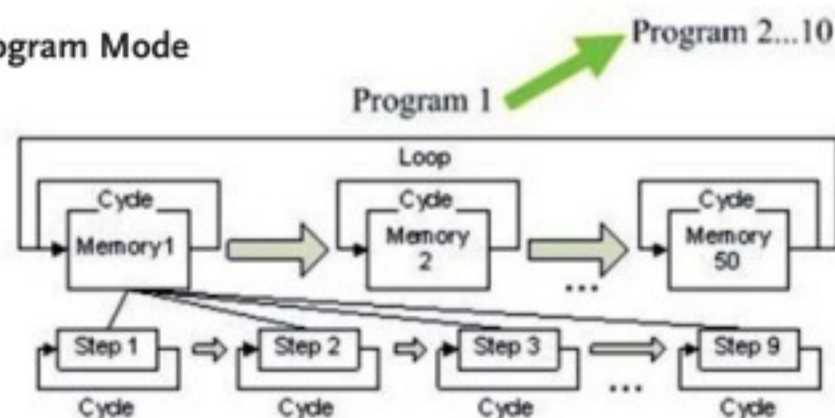

This mode allows users to set ceiling and floor specifications to produce PASS/FAIL result after the measurement is done. It can also show test results for each test procedure or only show the last result.

There are ten sets of Program mode and each set has 50 sets of memory. Each memory comprises 9 steps. Each Program will operate according to memory sequence, self-defined loops or designated steps to stop.

G SURGE/DIP CONTROL



Surge



Dip

Overlapping a Surge/Dip voltage on a normal voltage as the input power for DUT allows users to simulate Surge/Dip situation and evaluate DUT characteristics.

H. FUNCTION WAVEFORM (ARB) MODE

Provide waveforms in seven categories and 20,000 waveform combinations so as to rapidly simulate distorted AC voltage waveforms.

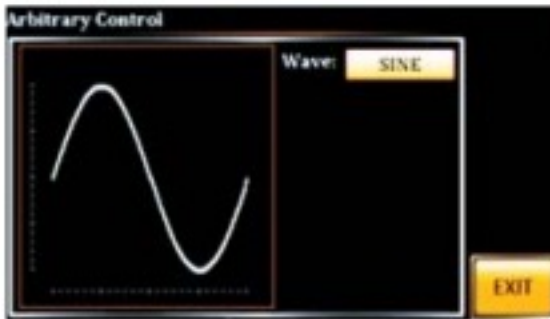

Sine Waveform
Standard AC Waveform



Triangle Waveform
Power Harmonic Output Simulation
Is Triangle Waveform



Staircase Waveform
Simulate Square Waveform And Staircase
Waveform For Commercial Ups

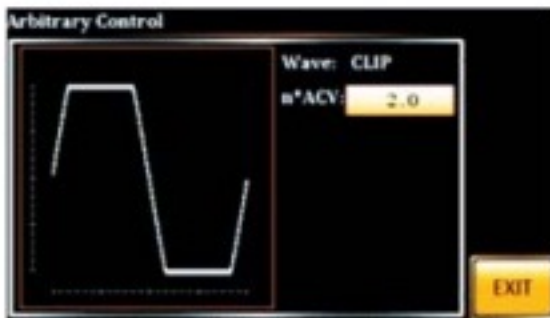

Clipped Sinewave
Simulate Grid Power Supply Heavy
Load Waveform



Crest Factor Waveform
Simulate Rectified Filter Current
Waveform By Capacitor Input

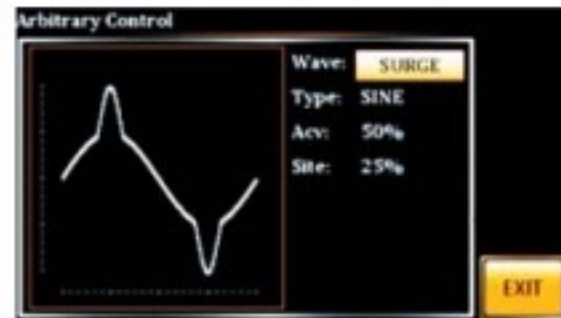

Surge Waveform
Simulate Grid Power Supply's
Peak Over-voltage

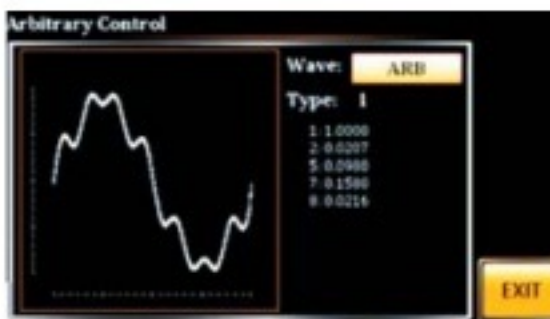

Fourier Series Synthesized Waveform

Simulate real output power waveform. Distorted power waveform is produced due to output impedance and non-linear effect such as inductance, capacitance, and parasitic capacitance effect. For example: motors.

I. RAMP CONTROL

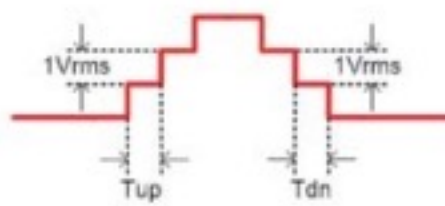

$T_{up} \rightarrow 0.1 \sim 999.9\text{ms}$
 $T_{dn} \rightarrow 0.1 \sim 999.9\text{ms}$

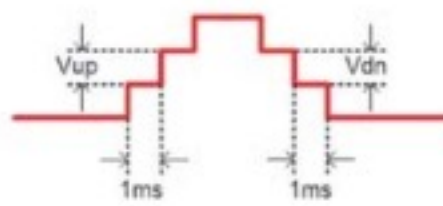

$V_{up} \rightarrow 0.01 \sim 99.99\text{Vrms}$
 $V_{dn} \rightarrow 0.01 \sim 99.99\text{Vrms}$

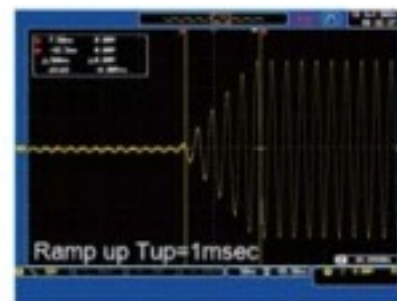

Mode=Time, $T_{up}=1\text{msec}$,
 $V_{AC}=100\text{V}$, Freq=50Hz,
Ramp output=on.

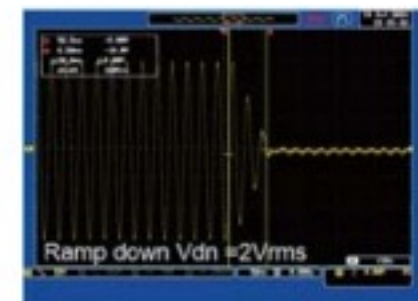

Mode=Voltage, $V_{dn}=2\text{Vrms}$,
 $V_{AC}=100\text{V}$, Freq=50Hz,
Ramp output=off.

Ramp control allows users to set output voltage rise or fall speed which is based on time (1ms) or voltage (1Vrms) unit.

500/1000 VA AC Power Source



APS-7050E



APS-7100E



FEATURES

- * 4.3" large LCD Display
- * Output Capacity:
APS-7050E (500VA, 310Vrms, 4.2/2.1Arms)
APS-7100E (1000VA, 310Vrms, 8.4/4.2Arms)
- * Measurement Function :
Voltage, Current, Power, Frequency, Power Factor, Ipeak
- * Reverse Current Alarm Function
- * 10 Sets of The Test Mode Simulate Power Transient Output
- * 10 Sets of Preset Allow Users to Store Ten Settings
- * OCP/OPP/OTP Protection
- * Variable Voltage, Frequency and Current Limiter
- * Universal Power Inlet

GW Instek launches the APS-7000E series the economy version of the APS-7000 programmable AC power source. With the height of 2U, the maximum rated output for APS-7050E is 500VA, 310Vrms, 4.2Arms and APS-7100E is 1000VA, 310Vrms, 8.4Arms. The output frequency range of the series is 45~500Hz. The series is ideal for the test and development of DC power supply devices, consumer electronics, automotive electronics and electronic components.

The APS-7000E series comprises six measurement and test functions (Vrms, Irms, F, Ipk, W, PF), and provides user interface similar to that of AC Power Meter. The APS-7000E series, via switching many sets of current levels to increase small current measurement resolution, is ideal for the LED industry and standby mode power consumption test. Ten sets of Preset allow users to store ten settings.

To meet the test criteria of line voltage fluctuation often seen in consumer electronics, the APS-7000E series not only provides a stable AC power source but also features the Test mode to satisfy special or abnormal voltage and frequency variation demands. Ten sets of the Test mode simulate power outage, voltage rise, and voltage fall. The APS-7000E series that simulates waveforms of city power grid's transient changes is suitable for verifying electronics products operated under abnormal power source.

The APS-7000E series is the economy version of the APS-7000 series. If communications interface and larger voltage/frequency are required, please refer to the APS-7000 series.

SPECIFICATIONS

Model	APS-7050E	APS-7100E
Power Rating	500VA	1000VA
Output Voltage	0 – 155Vrms/0 – 310.0 Vrms	0 – 155Vrms/0 – 310.0 Vrms
Output Frequency	45.00 – 500.0 Hz	45.00 – 500.0 Hz
Maximum Current (r.m.s)	0–155Vrms 0–310Vrms	8.4A 4.2A
Maximum Current (peak)	0–155Vrms 0–310Vrms	16.8A 33.6A
Total Harmonic Distortion (THD)	≤ 0.5% at 45 – 500Hz (Resistive Load)	
Crest Factor	≤ 4	
Line Regulation	0.1% (% of full scale)	
Load Regulation	0.3% (% of full scale)	
Response Time	<100μs	
Reverse Current	30% of Maximum Output RMS Current (Continue); 100% of Maximum Output RMS Current (Within 3 minutes)	
SETTING		
Voltage	Range	0 – 155Vrms/0 – 310Vrms/Auto
	Resolution	0.01V at 0.00 – 99.99Vrms; 0.1V at 100.0 – 310.0Vrms
	Accuracy	±(0.5% of setting+2 counts)
Frequency	Range	45 – 500Hz
	Resolution	0.01Hz at 45.00 – 99.99Hz/0.1Hz at 100.0 – 500.0Hz
	Accuracy	±0.02% of setting
MEASUREMENT		
Voltage(RMS)	Range	0.20–38.75Vrms/38.76–77.50 Vrms/77.51–155.0Vrms/155.1–310.0Vrms
	Resolution	0.01V at 0.00 – 99.99Vrms; 0.1V at 100.0 – 310.0Vrms
	Accuracy	±(0.5% of reading + 2 counts)
Frequency	Range	45 – 500Hz
	Resolution	0.01Hz (at 45Hz–99.99Hz)/0.1Hz (at 100Hz–500.0Hz)
	Accuracy	±0.1Hz
Current(RMS)	Range	2.00 – 70.00mA/60.0 – 350.0mA/0.300 – 3.500A/3.00 – 17.5A
	Resolution	0.01mA, 0.1mA, 0.001A, 0.01A
	Accuracy	±(0.6% of reading+5 counts); 2.00–350.0mA/±(0.5% of reading+5 counts); 0.350–3.500A/±(0.5% of reading+3 counts);3.500–17.50A
Current(Peak)	Range	0.0 – 70.0A
	Resolution	0.1A
	Accuracy	±(1% of reading+1 count)
Power(W)	Resolution	0.01W, 0.1W, 1W
	Accuracy	±(0.6% of reading+5 counts); 0.20–99.99W; ±(0.6% of reading+5 counts); 100.0–999.9W ±(0.6% of reading+2 counts); 1000–9999W
Power Factor	Resolution	0.001
	Accuracy	±(2% of reading + 2 counts)
GENERAL		
Number of Preset	10(0–9 Numeric keys)	
Protection	OCP, OPP, OTP and Alarm	



APS-7050E



APS-7100E

APS-7050E Rear Panel



APS-7100E Rear Panel



SPECIFICATIONS		
Model	APS-7050E	APS-7100E
ENVIRONMENT CONDITIONS		
Operation Temperature	0 – +40°C	
Storage Temperature	-10 – +70°C	
Operating Humidity	20 – 80% RH (No Condensation)	
Storage Humidity	80% RH or less (No Condensation)	
AC INPUT		
Input Power Source	1φ AC 115/230Vac ±15%	
DIMENSIONS & WEIGHT		
	430(W) x 88(H) x 400(D) mm; Approx. 24kg	430(W) x 88(H) x 560(D) mm; Approx. 38kg

ORDERING INFORMATION	
APS-7050E	500VA AC Power Source
APS-7100E	1000VA AC Power Source
ACCESSORIES :	
CD ROM (User Manual) x 1, Power Cord (Region Dependent), Mains Terminal Cover Set, GTL-123 Test Lead	
OPTIONAL ASSESSORIES	
GRA-423	Rack Mount Kit (APS-7000E Series)

Mains Terminal Cover Set

For: APS-7100/7100E Series



For: APS-7050/7050E Series



**APS-7000E Series
Europe Type Output Outlet**





ELECTRONIC LOADS

GW Instek provides DC electronic loads, AC/DC electronic loads, which allow users to flexibly test various batteries, energy storage systems, and power supply devices. DC electronic load can simulate load characteristics, including static, dynamic, constant current, constant resistance, constant voltage, constant power and short circuit. AC/DC electronic load can simulate sine wave current load in the CC mode, non-sine wave current load in the linear CC mode, and AC rectified load in the rectifier mode.

Electronic loads can be simply divided into multi-channel electronic loads and single-channel electronic loads according to application requirements. The multi-channel electronic load can test and measure multiple sets of low-power and different specifications of power output devices at the same time; and the single-channel electronic load can, based on the characteristics of a single load, choose high power, high voltage, high precision, high resolution or fast dynamic response to conduct test and measurement.

Electric vehicles, solar energy, energy storage systems, server power supplies, and power electronics, etc., can use the built-in dedicated test modes of GW Instek electronic loads to simplify user's operating procedures and shorten the test time. For example: using the CC+CV, CP+CV, CC+UVP, CP+UVP battery discharge modes to discharge electric vehicle battery can avoid over-discharge and protect the battery at the same time. The MPPT mode can quickly obtain the maximum power point of the solar panel.

PRODUCTS

- Multi-channel Electronic Loads
- High Power DC Electronic Load
- DC Electronic Load
- AC & DC Electronic Load

DC ELECTRONIC LOADS

MULTI-CHANNEL DC ELECTRONIC LOAD MODULES

Model	Operation Voltage	Operation Current	Power	Channel	Weight(kg)	Page
PEL-2020A(B)	0 ~ 80V	20A	100/100W	2	3.8	D105-108
PEL-2030A(B)	0 ~ 80V	5/40A	30/250W	2	3.8	
PEL-2040A(B)	0 ~ 80V	70A	350W	1	3.8	
PEL-2041A(B)	0 ~ 500V	10A	350W	1	3.8	

DC ELECTRONIC LOADS

Model	Operation Voltage	Operation Current	Power	Channel	Weight(kg)	Page	
PEL-503-80-50	0 ~ 80V	50A	250W	1	5.3	D117-118	
PEL-504-80-70	0 ~ 80V	70A	350W	1	5.3		
PEL-507-80-140	0 ~ 80V	140A	700W	1	10.3		
PEL-3021	0 ~ 150V	35A	175W	1	6	D93-98	
PEL-3031E	0 ~ 150V	60A	300W	1	7.5	D99-104	
PEL-3041	0 ~ 150V	70A	350W	1	7	D93-98	
PEL-3111	0 ~ 150V	210A	1050W	1	17		
PEL-3211	0 ~ 150V	420A	2100W	1	23		
PEL-3212	0 ~ 150V	420A	2100W	1	67.5		
PEL-3322	0 ~ 150V	630A	3150W	1	73		
PEL-3323	0 ~ 150V	630A	3150W	1	85.5		
PEL-3424	0 ~ 150V	840A	4200W	1	110		
PEL-3533	0 ~ 150V	1050A	5250W	1	96.5		
PEL-3535	0 ~ 150V	1050A	5250W	1	127.5		
PEL-3744	0 ~ 150V	1470A	7350W	1	125		
PEL-3955	0 ~ 150V	1890A	9450W	1	149		
PEL-3032E	0 ~ 500V	15A	300W	1	7.5		D99-104
PEL-504-500-15	0 ~ 500V	15A	350W	1	5.3		D117-118
PEL-507-500-30	0 ~ 500V	30A	700W	1	10.3		
PEL-3021H	0 ~ 800V	8.75A	175W	1	6	D93-98	
PEL-3041H	0 ~ 800V	17.5A	350W	1	7		
PEL-3111H	0 ~ 800V	52.5A	1050W	1	17		
PEL-3211H	0 ~ 800V	105A	2100W	1	23		
PEL-3212H	0 ~ 800V	105A	2100W	1	67.5		
PEL-3322H	0 ~ 800V	157.5A	3150W	1	73		
PEL-3323H	0 ~ 800V	157.5A	3150W	1	85.5		
PEL-3424H	0 ~ 800V	210A	4200W	1	110		
PEL-3533H	0 ~ 800V	262.5A	5250W	1	96.5		
PEL-3535H	0 ~ 800V	262.5A	5250W	1	127.5		
PEL-3744H	0 ~ 800V	367.5A	7350W	1	125		
PEL-3955H	0 ~ 800V	472.5A	9450W	1	149		

DC ELECTRONIC LOADS

HIGH POWER DC ELECTRONIC LOADS

Model	Operation Voltage	Operation Current	Power	Channel	Weight(kg)	Page
PEL-5006C-150-600	150V	600A	6kW	1	62	D109-116
PEL-5008C-150-800	150V	800A	8kW	1	77.5	
PEL-5010C-150-1000	150V	1000A	10kW	1	84.8	
PEL-5012C-150-1200	150V	1200A	12kW	1	92	
PEL-5015C-150-1500	150V	1500A	15kW	1	116.5	
PEL-5018C-150-1800	150V	1800A	18kW	1	124	
PEL-5020C-150-2000	150V	2000A	20kW	1	140.5	
PEL-5024C-150-2000	150V	2000A	24kW	1	155	
PEL-5006C-600-420	600V	420A	6kW	1	62	
PEL-5008C-600-560	600V	560A	8kW	1	77.5	
PEL-5010C-600-700	600V	700A	10kW	1	84.8	
PEL-5012C-600-840	600V	840A	12kW	1	92	
PEL-5015C-600-1050	600V	1050A	15kW	1	116.5	
PEL-5018C-600-1260	600V	1260A	18kW	1	124	
PEL-5020C-600-1400	600V	1400A	20kW	1	140.5	
PEL-5024C-600-1680	600V	1680A	24kW	1	155	
PEL-5006C-1200-240	1200V	240A	6kW	1	62	
PEL-5008C-1200-320	1200V	320A	8kW	1	77.5	
PEL-5010C-1200-400	1200V	400A	10kW	1	84.8	
PEL-5012C-1200-480	1200V	480A	12kW	1	92	
PEL-5015C-1200-600	1200V	600A	15kW	1	116.5	
PEL-5018C-1200-720	1200V	720A	18kW	1	124	
PEL-5020C-1200-800	1200V	800A	20kW	1	140.5	
PEL-5024C-1200-960	1200V	960A	24kW	1	155	
PEL-5004G-150-400	150V	400A	4kW	1	28	D125-128
PEL-5005G-150-500	150V	500A	5kW	1	28	
PEL-5006G-150-600	150V	600A	6kW	1	28	
PEL-5004G-600-280	600V	280A	4kW	1	29	
PEL-5005G-600-350	600V	350A	5kW	1	29	
PEL-5006G-600-420	600V	420A	6kW	1	29	
PEL-5004G-1200-160	1200V	160A	4kW	1	29	
PEL-5005G-1200-200	1200V	200A	5kW	1	29	
PEL-5006G-1200-240	1200V	240A	6kW	1	29	

DC ELECTRONIC LOADS

AC/DC ELECTRONIC LOADS

Model	Operation Voltage	Operation Current	Power	Channel	Weight(kg)	Page
AEL-5002-350-18.75	350V	18.75A	1875W	1	21.5	D119-124
AEL-5003-350-28	350V	28A	2800W	1	27.5	
AEL-5004-350-37.5	350V	37.5A	3750W	1	33.5	
AEL-5006-350-56	350V	56A	5600W	1	58	
AEL-5008-350-75	350V	75A	7500W	1	70	
AEL-5012-350-112.5	350V	112.5A	11250W	1	105	
AEL-5015-350-112.5	350V	112.5A	15000W	1	140	
AEL-5019-350-112.5	350V	112.5A	18750W	1	260	
AEL-5023-350-112.5	350V	112.5A	22500W	1	295	
AEL-5002-425-18.75	425V	18.75A	1875W	1	21.5	
AEL-5003-425-28	425V	28A	2800W	1	27.5	
AEL-5004-425-37.5	425V	37.5A	3750W	1	33.5	
AEL-5006-425-56	425V	56A	5600W	1	58	
AEL-5008-425-75	425V	75A	7500W	1	70	
AEL-5012-425-112.5	425V	112.5A	11250W	1	105	
AEL-5015-425-112.5	425V	112.5A	15000W	1	140	
AEL-5019-425-112.5	425V	112.5A	18750W	1	260	
AEL-5023-425-112.5	425V	112.5A	22500W	1	295	
AEL-5003-480-18.75	480V	18.75A	2800W	1	27.5	
AEL-5004-480-28	480V	28A	3750W	1	33.5	

Programmable D.C. Electronic Load



PEL-3111/3111H



PEL-3041/3041H/3021/3021H



FEATURES

- * Operating Voltage (DC) : 0~150V(PEL-3000)/ 0~800V(PEL-3000H)
- * Operating Mode : C.C/C.V/C.R/C.P/C.C+C.V/ C.R+C.V/C.P+C.V
- * Parallel Connection of Inputs for Higher Capacity (Max : 9,450W)
- * Support of High Slew Rate : Max 16A/ μ s (PEL-3000)/0.84A/ μ s (PEL-3000H)
- * Run Program Function (Go/NoGo Test)
- * Sequence Function for High Efficient Load Simulations
- * Dynamic (Switching) Function : 0.0166Hz~20kHz
- * Soft Start Function : Off/On (1~200ms, Res. 1ms)
- * Adjustable OCP/OVP/OPP/UVP Setting
- * Short Circuit Function
- * Timer Function : Elapsed Time of Load on
- * Cut Off Time (Auto Load Off Timer) : 1s to 999h 59min 59s or Off
- * External Channel Control/Monitoring Via Analog Control Connector
- * Setup Memories : 100 sets
- * 3.5 Inch TFT LCD Display
- * Multi Interface : USB, RS-232 (Std.)/ GPIB, LAN (Opt.)

Rear Panel



The PEL-3000 Series, a single-channel, programmable D.C. electronic load with 0.01mA current resolution and 16A/ μ s current Slew Rate, is very ideal for testing server power supply and SPS(Switching Power Supply) for commercial and industrial computers. For a heavy-duty device like cloud ecosystem running 24-hour nonstop operations, a stable and high-power power supply, ranging from 350W to 1500W, is required to maintain the normal operation of server, Hub, and the equipment of data storage and internet communications. Owing to the increasing demand of data transmission and large scale data storage of telecommunications systems, the infrastructure of internet communications is in the pace of rapid expansion. This has greatly boosted the market demand of telecommunications equipment powered by power supply of 2000W and above. The flexible power combination of PEL-3000 Series meets the test requirements of present high-power power supply. The PEL-3000H Series programmable DC Electronic load, which not only inherited functions and features from the PEL-3000 Series but providing three current ranges for all PEL-3000H Series and adding voltage monitor BNC terminals on the front panel. The PEL-3000H Series, a single-channel, programmable D.C. electronic load with 800V and 0.84A/ μ s current Slew Rate, is ideal for the test of the high voltage devices such as the EV & HEV in-vehicle chargers, DC/DC converters or high-voltage batteries. With respect to battery testing applications such as rechargeable battery for electrical tools, battery module and automobile battery, PEL-3000(H) Series has three stand-alone models to offer including 175W, 350W, 1050W and Booster. By connecting Booster 2100W units with master units, the maximum load capacity of the whole system can reach 9,450W. Hence, the PEL-3000(H) Series fulfills various power testing requirements including medium to low power or high-power power supply.

The PEL-3000(H) Series has seven operating modes and three operating functions. Among the seven operating modes, four of them are basic operating modes, including constant current, constant voltage, constant resistance, and constant power, and the other three are advanced operating modes including constant current + constant voltage, constant resistance + constant voltage, and constant power + constant voltage. Users must first select operating mode and then operating function based upon the test requirements. Static, Dynamic and Sequence operating functions can be applied to different testing conditions including a fixed load level, switching between two levels or switching among more than two levels. Sequence function is divided into Fast Sequence and Normal Sequence according to the test time of each step. Both Dynamic and Sequence are to assist users to simulate the genuine load change. For instance, PEL-3000(H) Series can simulate HEV current consumption to make sure that automobile battery can supply HEV with sufficient power need on the road. By so doing, manufacturers can elevate product quality and reliability.

The Soft Start function of the PEL-3000(H) Series can set current rise time for the moment PEL-3000(H) Series is turned on to reduce the abnormal situation of the voltage drop of power supply under test. The adjustable Under Voltage Protection(UVP), GO/NO GO voltage input monitoring function, current monitoring function and Timer Function to control load activation time can be jointly applied to the characteristic tests of battery bleeding to avoid battery damage during bleeding operation. Based upon the functionalities described above, the PEL-3000(H) Series can test a vast variety of power supply ranging from the fundamental static sink current to complex dynamic load simulations so as to enhance product quality and reliability.

The single unit D.C Electronic Load of PEL-3000(H) Series

The PEL-3000(H) Series is a high speed, single channel and programmable D.C. electronic load and its power, functionality, parallel combination and size are listed on the following chart :

MODEL	PEL-3021/3021H	PEL-3041/3041H	PEL-3111/3111H	PEL-3211/3211H
Power	175W	350W	1,050W	2,100W Booster
Function	Full-function Single Unit	Full-function Single Unit	Full-function Single Unit	No control panel, can not be operated alone
Parallel Combination	Parallel with same model, 5 units the maximum	Parallel with same model, 5 units the maximum	Parallel with same model, 5 units the maximum Parallel with the maximum of four PEL-3211(H)s	Parallel with PEL-3111(H)
Size	Half Rack	Half Rack	Full Rack	Full Rack

Note:

- *1. Full scale of H range
- *2. Vin: input terminal voltage of electronic load
- *3. M range applies to the full scale of H range
- *4. Siemens[S] = Input current[A] / Input voltage[V] = 1/resistance[Ω]
- *5. Converted value at the input current. At the input current. It is not applied for the condition of the parallel operation.
- *6. set = Vin/Rset
- *7. At the sensing point during remote sensing under the operating range of the input voltage. It is also applied for the condition of the parallel operation.
- *8. It is not applied for the condition of the parallel operation.
- *9. Time to reach from 10 % to 90 % when the current is varied from 2 % to 100 % (20 % to 100 % in M range) of the rated current.
- *10. N = Number of units in parallel (same model)
- *11. N = Number of units in parallel (same model) or N = 1 + 2 x (Number of units in parallel [PEL-3211])

SPECIFICATIONS													
Model	PEL-3021			PEL-3041			PEL-3111			PEL-3211			
Voltage	0V-150V			0V-150V			0V-150V			0V-150V			
Current	35A			70A			210A			420A			
Power	175W			350W			1050W			2100W			
Input Resistance	500 kΩ			500 kΩ			500 kΩ			500 kΩ			
Min. Operating Voltage(DC)(Typ.)	0.75V@17.5A 1.5V@35A			0.75V@35A 1.5V@70A			0.75V@105A 1.5V@210A			0.75V@210A 1.5V@420A			
CONSTANT CURRENT MODE													
Operating Range	H, M, L	0-35A	0-3.5A	0-0.35A	0-70A	0-7A	0-0.7A	0-210A	0-21A	0-2.1A	420A		
Accuracy of Setting	H, M	$\pm(0.2\% \text{ of set} + 0.1\% \text{ of f.s.}^{(1)}) + V_{in}^{(2)}/500 \text{ k}\Omega$									$\pm(1.2\% \text{ of set} + 1.1\% \text{ of f.s.}^{(1)})$		
Accuracy of Setting	L	$\pm(0.2\% \text{ of set} + 0.1\% \text{ of f.s.}^{(1)}) + V_{in}^{(2)}/500 \text{ k}\Omega$									N/A		
Accuracy of Setting(Parallel)		$\pm(1.2\% \text{ of set} + 1.1\% \text{ of f.s.}^{(1)})$									$\pm(1.2\% \text{ of set} + 1.1\% \text{ of f.s.}^{(1)})$		
Resolution	H, M, L	1mA	0.1mA	0.01mA	2mA	0.2mA	0.02mA	10mA	1mA	0.1mA	N/A		
CR MODE													
Operating Range	Range	H	23.3336S-400μS (42.857mΩ-2.5kΩ)			46.6672S-800μS (21.428mΩ-1.25kΩ)			140.0016S-2.4mS (7.1427mΩ-416.6667Ω)			280.0032S-4.8mS (3.5714mΩ-208.3334Ω)	
		M	2.33336S-40μS (428.566mΩ-25kΩ)			4.6667S-80μS (214.28mΩ-12.5kΩ)			14.0001S-242.4μS (71.427mΩ-4.16667kΩ)			28.0032S-484.8μS (35.7135mΩ-2.083334Ω)	
		L	0.233336S-4μS (4.28566Ω-250kΩ)			0.46667S-8μS (2.1428Ω-125kΩ)			1.40001S-24.24μS (714.27mΩ-41.6667kΩ)			N/A	
Accuracy of Setting	H, M	$\pm(0.5\% \text{ of set}^{(1)} + 0.5\% \text{ of f.s.}^{(1)}) + V_{in}^{(2)}/500\text{k}\Omega$									$\pm(1.2\% \text{ of set}^{(1)} + 1.1\% \text{ of f.s.}^{(1)})$		
Accuracy of Setting	L	$\pm(0.5\% \text{ of set}^{(1)} + 0.5\% \text{ of f.s.}^{(1)}) + V_{in}^{(2)}/500\text{k}\Omega$									N/A		
Parallel		$\pm(1.2\% \text{ of set} + 1.1\% \text{ of f.s.}^{(1)})$									$\pm(1.2\% \text{ of set} + 1.1\% \text{ of f.s.}^{(1)})$		
Resolution	H, M, L	400μS	40μS	4μS	800μS	80μS	8μS	2.4mS	240μS	24μS	N/A		
CONSTANT VOLTAGE MODE													
Operating Range	Range	H	1.5V-150V									1.5V-150V	
		L	1.5V-15V									1.5V-15V	
Accuracy of Setting	H, L	$\pm(0.1\% \text{ of set} + 0.1\% \text{ of f.s.})$									N/A		
Resolution	H, L	10mV/1mV									N/A		
CONSTANT POWER MODE													
Operating Range	Range	H	17.5W-175W			35W-350W			105W-1050W			210W-2100W	
		M	1.75W-17.5W			3.5W-35W			10.5W-105W			21W-210W	
		L	0.175W-1.75W			0.35W-3.5W			1.05W-10.5W			N/A	
Accuracy of Setting	H, M, L	$\pm(0.6\% \text{ of set}^{(1)} + 1.4\% \text{ of f.s.}^{(1)}) + V_{in}^{(2)}/500\text{k}\Omega$									N/A		
Resolution	H, M, L	10mW	1mW	0.1mW	10mW	1mW	0.1mW	100mW	10mW	1mW	N/A		
PARALLEL Mode													
Capacity		875W			1750W			5250W			PEL-3111 with 4 booster units : Max 9.45kW		
SLEW RATE													
Operation Mode		CC, CR			CC, CR			CC, CR			N/A		
Setting Range (CC mode)	Range	H	2.5 x N ¹⁰ mA/μs-2.5A/μs			5 x N ¹⁰ mA/μs-5A/μs			16 x N ¹¹ mA/μs-16A/μs			N/A	
		M	250 x N ¹⁰ μA/μs-250mA/μs			500 x N ¹⁰ μA/μs-500mA/μs			1.6 x N ¹¹ mA/μs-1.6A/μs			N/A	
		L	25 x N ¹⁰ μA/μs-25mA/μs			50 x N ¹⁰ μA/μs-50mA/μs			160 x N ¹¹ μA/μs-160mA/μs			N/A	
Setting Range (CR Mode)	Range	H	250 x N ¹⁰ μA/μs-250mA/μs			500 x N ¹⁰ μA/μs-500mA/μs			1.6 x N ¹¹ mA/μs-1.6A/μs			N/A	
		M	25 x N ¹⁰ μA/μs-25mA/μs			50 x N ¹⁰ μA/μs-50mA/μs			160 x N ¹¹ μA/μs-160mA/μs			N/A	
		L	2.5 x N ¹⁰ μA/μs-2.5mA/μs			5 x N ¹⁰ μA/μs-5mA/μs			16 x N ¹¹ μA/μs-16mA/μs			N/A	
Accuracy of Setting	H, M, L	$\pm(10\% \text{ of set}^{(1)} + 5\mu\text{s})$									N/A		
Resolution (Setting Range)		1 x N ¹⁰ mA 250 x N ¹⁰ mA/μs-2.5A/μs 100 x N ¹⁰ μA 25 x N ¹⁰ mA/μs-250 x N ¹⁰ mA/μs 10 x N ¹⁰ μA 2.5 x N ¹⁰ mA/μs-25 x N ¹⁰ mA/μs 1 x N ¹⁰ μA 250 x N ¹⁰ μA/μs-2.5 x N ¹⁰ mA/μs 100 x N ¹⁰ nA 25 x N ¹⁰ μA/μs-250 x N ¹⁰ μA/μs 10 x N ¹⁰ nA 2.5 x N ¹⁰ μA/μs-25 x N ¹⁰ μA/μs			2 x N ¹⁰ mA 500 x N ¹⁰ mA/μs-5A/μs 200 x N ¹⁰ μA 50 x N ¹⁰ mA/μs-500 x N ¹⁰ mA/μs 20 x N ¹⁰ μA 5 x N ¹⁰ mA/μs-50 x N ¹⁰ mA/μs 2 x N ¹⁰ μA 500 x N ¹⁰ μA/μs-5 x N ¹⁰ mA/μs 200 x N ¹⁰ nA 50 x N ¹⁰ μA/μs-500 x N ¹⁰ μA/μs 20 x N ¹⁰ nA 5 x N ¹⁰ μA/μs-50 x N ¹⁰ μA/μs			6 x N ¹¹ mA 1.6 x N ¹¹ A/μs-16A/μs 600 x N ¹¹ μA 160 x N ¹¹ mA/μs-1.6 x N ¹¹ A/μs 60 x N ¹¹ μA 16 x N ¹¹ mA/μs-160 x N ¹¹ mA/μs 6 x N ¹¹ μA 1.6 x N ¹¹ mA/μs-16 x N ¹¹ mA/μs 600 x N ¹¹ nA 160 x N ¹¹ μA/μs-1.6 x N ¹¹ μA/μs 60 x N ¹¹ nA 16 x N ¹¹ μA/μs-160 x N ¹¹ μA/μs			N/A		
METER													
Voltmeter	Accuracy	$\pm(0.1\% \text{ of rdg} + 0.1\% \text{ of f.s.})$									N/A		
Ammeter	Accuracy	$\pm(0.2\% \text{ of rdg} + 0.3\% \text{ of f.s.})$									N/A		
Ammeter(Parallel Operation)	Accuracy	$\pm(1.2\% \text{ of rdg} + 1.1\% \text{ of f.s.})$									N/A		
DYNAMIC MODE													
Operation Mode		CC, CR and CP											
T1 & T2 Accuracy		0.025ms-10ms/Res : 1μs ; 1ms-60s/Res : 1ms ±100ppm of setting											
Slew Rate (CC Mode)	Range	H	2.5mA/μs-2.5A/μs			5mA/μs-5A/μs			16mA/μs-16A/μs			N/A	
		M	250μA/μs-250mA/μs			500μA/μs-500mA/μs			1.6mA/μs-1.6A/μs			N/A	
		L	25μA/μs-25mA/μs			50μA/μs-50mA/μs			160μA/μs-160mA/μs			N/A	
Slew Rate (CR Mode)	Range	H	250μA/μs-250mA/μs			500μA/μs-500mA/μs			1.6mA/μs-1.6A/μs			N/A	
		M	25μA/μs-25mA/μs			50μA/μs-50mA/μs			160μA/μs-160mA/μs			N/A	
		L	2.5μA/μs-2.5mA/μs			5μA/μs-5mA/μs			16μA/μs-16mA/μs			N/A	
Current Accuracy		±0.4%F.S.			±0.4%F.S.			±0.4%F.S.			$\pm(1.2\% \text{ of set} + 1.1\% \text{ of F.S.})$		
PROTECTION FUNCTION													
Functions		Overvoltage protection(OVP), Overcurrent protection(OCP), Overpower protection(OPP), Overheat protection(OHP), Undervoltage protection(UVP), Reverse connection protection(REV)											
GENERAL													
Input Range		90VAC-132VAC/180VAC-250VAC Single-phase; 47Hz-63Hz											
Power(Max.)		90VA			110VA			190VA			230VA		
Interface		USB/RS232/Analog Control (Standard) ; GPIB/LAN (Option)											
Dimensions & Weight		214.5(W)x124(H)x400(D)mm; Approx. 6kg			214.5(W)x124(H)x400(D)mm; Approx. 7kg			429.5(W)x128(H)x400(D)mm; Approx. 17kg			427.7(W)x128(H)x592.5(D)mm; Approx. 23kg		

Programmable D.C. Electronic Load

SPECIFICATIONS

Model	PEL-3212	PEL-3323	PEL-3424	PEL-3535	PEL-3322	PEL-3533	PEL-3744	PEL-3955		
Voltage	0V-150V	0V-150V	0V-150V	0V-150V	0V-150V	0V-150V	0V-150V	0V-150V		
Current	0-420A	0-630A	0-840A	0-1050A	0-630A	0-1050A	0-1470A	0-1890A		
Power	2100W	3150W	4200W	5250W	3150W	5250W	7350W	9450W		
Input Resistance	250 kΩ	166.7 kΩ	125 kΩ	100 kΩ	500 kΩ	500 kΩ	500 kΩ	500 kΩ		
Min. Operating Voltage(DC)(Typ.)	0.75V@210A 1.5V@420A	0.75V@315A 1.5V@630A	0.75V@420A 1.5V@840A	0.75V@525A 1.5V@1050A	0.75V@315A 1.5V@630A	0.75V@525A 1.5V@1050A	0.75V@735A 1.5V@1470A	0.75V@945A 1.5V@1890A		
CONSTANT CURRENT MODE										
Operating Range	H, M, L	0-420A 0-42A 0-4.2A	0-630A 0-63A 0-6.3A	0-840A 0-84A 0-8.4A	0-1050A 0-105A 0-10.5A	0-630A 0-63A N/A	0-1050A 0-105A N/A	0-1470A 0-147A N/A	0-1890A 0-189A N/A	
Accuracy of Setting	H, M, L	±(0.2 % of set + 0.1 % of f.s.) + Vin ² / (500/N ¹⁸ kΩ)								
Resolution	H, M, L	20mA 2mA 0.2mA	30mA 3mA 0.3mA	40mA 4mA 0.4mA	50mA 5mA 0.5mA	30mA 3mA N/A	50mA 5mA N/A	70mA 7mA N/A	90mA 9mA N/A	
CR MODE										
Operating Range	Range	H	280.0032S-4.8mS (3.57138mΩ-208.333Ω)	420.0048S-7.2mS (2.38092mΩ-138.888Ω)	560.0064S-9.6mS (1.78569mΩ-104.166Ω)	700.008S-12mS (1.42855mΩ-83.3333Ω)	420.0048S-7.2mS (2.38092mΩ-138.888Ω)	700.008S-12mS (1.42855mΩ-83.3333Ω)	980.0112S-16.8mS (1.02039mΩ-59.5238Ω)	1260.0144S-21.6mS (793.641uΩ-46.2963Ω)
		M	28.00032S-480uS (35.7138mΩ-2083.33Ω)	42.00048S-720uS (23.8092mΩ-1388.88Ω)	56.00064S-960uS (17.8569mΩ-1041.66Ω)	70.0008S-1.2mS (14.2855mΩ-833.333Ω)	42.00048S-720uS (23.8092mΩ-1388.88Ω)	70.0008S-1.2mS (14.2855mΩ-833.333Ω)	98.00112S-1.68mS (10.2039mΩ-595.238Ω)	126.00144S-2.16mS (7.93641mΩ-462.963Ω)
		L	2.800032S-48uS (357.138mΩ-20.8333kΩ)	4.200048S-72uS (238.092mΩ-13.8888kΩ)	5.600064S-96uS (178.569mΩ-10.4166kΩ)	7.00008S-120uS (142.855mΩ-8.33333kΩ)	N/A	N/A	N/A	N/A
Accuracy of Setting	H, M, L	±(0.5 % of set ² + 0.5 % of f.s.) + Vin ² / (500/N ¹⁸ kΩ)								
Resolution	H, M, L	4.8mS 480uS 48uS	7.2mS 720uS 72uS	9.6mS 960uS 96uS	12mS 1.2mS 120uS	7.2mS 720uS -	12mS 1.2mS -	16.8mS 1.68mS -	21.6mS 2.16mS -	
CONSTANT VOLTAGE MODE										
Operating Range	Range	H	1.5V-150V							
		L	1.5V-15V							
Accuracy of Setting	H, L	±(0.1 % of set + 0.1 % of f.s.)								
Resolution	H, L	10mV/1mV								
CONSTANT POWER MODE										
Operating Range	Range	H	210W-2100W	315W-3150W	420W-4200W	525W-5250W	315W-3150W	525W-5250W	735W-7350W	945W-9450W
		M	21W-210W	31.5W-315W	42W-420W	52.5W-525W	31.5W-315W	52.5W-525W	73.5W-735W	94.5W-945W
		L	2.1W-21W	3.15W-31.5W	4.2W-42W	5.25W-52.5W	N/A	N/A	N/A	N/A
Accuracy of Setting	H, M, L	±(0.6 % of set + 1.4 % of f.s.) + Vin x Vin / (500/N ¹⁰ MΩ): alone operation specifications								
Resolution	H, M, L	200mW 20mW 2mW	300mW 30mW 3mW	400mW 40mW 4mW	500mW 50mW 5mW	300mW 30mW -	500mW 50mW -	700mW 70mW -	900mW 90mW -	
PARALLEL Mode										
Capacity		-								
SLEW RATE										
Operation Mode		CC, CR								
Setting Range (CC mode)	Range	H	32mA/μs-16A/μs	48mA/μs-16A/μs	64mA/μs-16A/μs	80mA/μs-16A/μs	48mA/μs-16A/μs	80mA/μs-16A/μs	112mA/μs-16A/μs	144mA/μs-16A/μs
		M	3.2mA/μs-1.6A/μs	4.8mA/μs-1.6A/μs	6.4mA/μs-1.6A/μs	8mA/μs-1.6A/μs	4.8mA/μs-1.6A/μs	8mA/μs-1.6A/μs	11.2mA/μs-1.6A/μs	14.4mA/μs-1.6A/μs
		L	320μA/μs-160mA/μs	480μA/μs-160mA/μs	640μA/μs-160mA/μs	800μA/μs-160mA/μs	N/A	N/A	N/A	N/A
Setting Range (CR Mode)	Range	H	3.2mA/μs-1.6A/μs	4.8mA/μs-1.6A/μs	6.4mA/μs-1.6A/μs	8mA/μs-1.6A/μs	4.8mA/μs-1.6A/μs	8mA/μs-1.6A/μs	11.2mA/μs-1.6A/μs	14.4mA/μs-1.6A/μs
		M	320μA/μs-160mA/μs	480μA/μs-160mA/μs	640μA/μs-160mA/μs	800μA/μs-160mA/μs	480μA/μs-160mA/μs	800μA/μs-160mA/μs	1.12mA/μs-160mA/μs	1.44mA/μs-160mA/μs
		L	32μA/μs-16mA/μs	48μA/μs-16mA/μs	64μA/μs-16mA/μs	80μA/μs-16mA/μs	N/A	N/A	N/A	N/A
Accuracy of Setting	H, M, L	±10 % of set ² + 5μs)								
Resolution (Setting Range)		12mA	18mA	24mA	30mA	18mA	30mA	42mA	54mA	
		1.6A/μs-16A/μs	1.6A/μs-16A/μs	1.6A/μs-16A/μs	1.6A/μs-16A/μs	1.6A/μs-16A/μs	1.6A/μs-16A/μs	1.6A/μs-16A/μs	1.6A/μs-16A/μs	
		1.2mA	1.8mA	2.4mA	3mA	1.8mA	3mA	4.2mA	5.4mA	
		160mA/μs-1.6A/μs	160mA/μs-1.6A/μs	160mA/μs-1.6A/μs	160mA/μs-1.6A/μs	160mA/μs-1.6A/μs	160mA/μs-1.6A/μs	160mA/μs-1.6A/μs	160mA/μs-1.6A/μs	
		120μA	180μA	240μA	300μA	180μA	300μA	420μA	540μA	
		16mA/μs-160mA/μs	16mA/μs-160mA/μs	16mA/μs-160mA/μs	16mA/μs-160mA/μs	16mA/μs-160mA/μs	16mA/μs-160mA/μs	16mA/μs-160mA/μs	16mA/μs-160mA/μs	
		12μA	18μA	24μA	30μA	18μA	30μA	42μA	54μA	
		1.6mA/μs-16mA/μs	1.6mA/μs-16mA/μs	1.6mA/μs-16mA/μs	1.6mA/μs-16mA/μs	1.6mA/μs-16mA/μs	1.6mA/μs-16mA/μs	1.6mA/μs-16mA/μs	1.6mA/μs-16mA/μs	
		1.2μA	1.8μA	2.4μA	3μA	1.8μA	3μA	4.2μA	5.4μA	
		160μA/μs-1.6mA/μs	160μA/μs-1.6mA/μs	160μA/μs-1.6mA/μs	160μA/μs-1.6mA/μs	160μA/μs-1.6mA/μs	160μA/μs-1.6mA/μs	160μA/μs-1.6mA/μs	160μA/μs-1.6mA/μs	
	120nA	180nA	240nA	300nA	180nA	300nA	N/A	N/A		
	16μA/μs-160μA/μs	16μA/μs-160μA/μs	16μA/μs-160μA/μs	16μA/μs-160μA/μs	N/A	N/A	N/A	N/A		
METER										
Voltmeter	Accuracy	±(0.1 % of rdg + 0.1 % of f.s.)								
Ammeter	Accuracy	±(0.2 % of rdg + 0.3 % of f.s.)								
DYNAMIC MODE										
Operation Mode		CC and CR								
T1 & T2 Accuracy		0.025ms-10ms/Res : 1μs ; 1ms-30s/Res : 1ms 1μs/1ms ± 100ppm								
Slew Rate (CC Mode)	Range	H	32mA/μs-16A/μs	48mA/μs-16A/μs	64mA/μs-16A/μs	80mA/μs-16A/μs	48mA/μs-16A/μs	80mA/μs-16A/μs	112mA/μs-16A/μs	144mA/μs-16A/μs
		M	3.2mA/μs-1.6A/μs	4.8mA/μs-1.6A/μs	6.4mA/μs-1.6A/μs	8mA/μs-1.6A/μs	4.8mA/μs-1.6A/μs	8mA/μs-1.6A/μs	11.2mA/μs-1.6A/μs	14.4mA/μs-1.6A/μs
		L	320μA/μs-160mA/μs	480μA/μs-160mA/μs	640μA/μs-160mA/μs	800μA/μs-160mA/μs	N/A	N/A	N/A	N/A
Slew Rate (CR Mode)	Range	H	3.2mA/μs-1.6A/μs	4.8mA/μs-1.6A/μs	6.4mA/μs-1.6A/μs	8mA/μs-1.6A/μs	4.8mA/μs-1.6A/μs	8mA/μs-1.6A/μs	11.2mA/μs-1.6A/μs	14.4mA/μs-1.6A/μs
		M	320μA/μs-160mA/μs	480μA/μs-160mA/μs	640μA/μs-160mA/μs	800μA/μs-160mA/μs	480μA/μs-160mA/μs	800μA/μs-160mA/μs	1.12mA/μs-160mA/μs	1.44mA/μs-160mA/μs
		L	32μA/μs-16mA/μs	48μA/μs-16mA/μs	64μA/μs-16mA/μs	80μA/μs-16mA/μs	N/A	N/A	N/A	N/A
Current Accuracy		±0.4%F.S.								
PROTECTION FUNCTION										
Functions		Overvoltage protection(OVP), Overcurrent protection(OCP), Overpower protection(OPP), Overheat protection(OHP), Undervoltage protection(UVP), Reverse connection protection(REV)								
GENERAL										
Input Range		90VAC-132VAC/180VAC-250VAC Single-phase; 47Hz-63Hz								
Power(Max.)		380VA	570VA	760VA	950VA	420VA	650VA	880VA	1110VA	
Interface		USB/RS232/Analog Control (Standard) ; GPIB/LAN (Option)								
Dimensions & Weight		598(W)x877(H)x706(D)mm; Approx. 67.5kg	598(W)x877(H)x706(D)mm; Approx. 85.5kg	598(W)x877(H)x706(D)mm; Approx. 110kg	598(W)x877(H)x706(D)mm; Approx. 127.5kg	598(W)x877(H)x706(D)mm; Approx. 73kg	598(W)x877(H)x706(D)mm; Approx. 96.5kg	598(W)x877(H)x706(D)mm; Approx. 125kg	598(W)x877(H)x706(D)mm; Approx. 149kg	

PEL-3000/3000(H) Series

DC ELECTRONIC LOADS

SPECIFICATIONS																																																																							
Model		PEL-3021H				PEL-3041H				PEL-3111H				PEL-3211H																																																									
Voltage		0V-800V				0V-800V				0V-800V				0V-800V																																																									
Current		8.75A				17.5A				52.5A				105A																																																									
Power		175W				350W				1050W				2100W																																																									
Input Resistance		3.24MΩ				3.24MΩ				3.24MΩ				3.24MΩ																																																									
Min. Operating Voltage(DC)(Typ.)		5V@8.75A 2.5V@4.375A				5V@17.5A 2.5V@8.75A				5V@52.5A 2.5V@26.25A				5V@105A 2.5V@52.5A																																																									
CONSTANT CURRENT MODE																																																																							
Operating Range		H, M, L		0-8.75A	0-8.75mA	0-87.5mA	0-17.5A	0-1.75A	0-175mA	0-52.5A	0-5.25A	0-525mA	0-105A	0-10.5A	0-1.05A																																																								
Accuracy of Setting		H, M		$\pm(0.2\% \text{ of set} + 0.1\% \text{ of f.s.}) + V_{in}^2/3.24M\Omega$								$\pm(1.2\% \text{ of set} + 1.1\% \text{ of f.s.})$																																																											
Accuracy of Setting		L		$\pm(0.2\% \text{ of set} + 0.1\% \text{ of f.s.}) + V_{in}^2/3.24M\Omega$								N/A																																																											
Accuracy of Setting(Parallel)				$\pm(1.2\% \text{ of set} + 1.1\% \text{ of f.s.})$								N/A																																																											
Resolution		H, M, L		300μA	30μA	3μA	0.6mA	60μA	6μA	2mA	200μA	20μA	4mA	400μA	40μA																																																								
CR MODE																																																																							
Operating Range		Range		H		M		L		H		M		L																																																									
				1.75S-30μS (571mΩ-33.3kΩ)		3.5S-60μS (285mΩ-16.6kΩ)		10.5S-180μS (95.2mΩ-5.55kΩ)		21S-360μS (47.6mΩ-2.777kΩ)		1.75S-30μS (5.71Ω-333kΩ)		3.5S-60μS (2.85Ω-166kΩ)		10.5S-180μS (952mΩ-55.5kΩ)		21S-360μS (476mΩ-27.77kΩ)																																																					
				17.5mS-0.3μS (57.1Ω-3.33MΩ)		35mS-0.6μS (28.5Ω-1.66MΩ)		105mS-1.8μS (9.52Ω-555kΩ)		210mS-3.6μS (4.762Ω-277.7kΩ)																																																													
Accuracy of Setting		H, M		$\pm(0.5\% \text{ set} + 0.5\% \text{ f.s.}) + V_{in}^2/3.24M\Omega$								$\pm(1.2\% \text{ of set} + 1.1\% \text{ of f.s.})TYP$																																																											
Accuracy of Setting		L		$\pm(0.5\% \text{ set} + 0.5\% \text{ f.s.}) + V_{in}^2/3.24M\Omega$								N/A																																																											
Parallel				$\pm(1.2\% \text{ of set} + 1.1\% \text{ of f.s.})$								N/A																																																											
Resolution		H, M, L		30μS	3μS	0.3μS	60μS	6μS	0.6μS	180μS	18μS	1.8μS	N/A																																																										
CONSTANT VOLTAGE MODE																																																																							
Operating Range		Range		H		L		H		L		H		L																																																									
				5V-800V		5V-80V		5V-800V		5V-80V		5V-800V		5V-80V																																																									
Accuracy of Setting		Range		H, L		$\pm(0.2\% \text{ of set} + 0.2\% \text{ of f.s.})$								$\pm(0.2\% \text{ of set} + 0.2\% \text{ of f.s.})$																																																									
		Parallel		TYP		$\pm(0.2\% \text{ of set} + 0.2\% \text{ of f.s.})$								$\pm(0.2\% \text{ of set} + 0.2\% \text{ of f.s.})$																																																									
Resolution		Range		H, L		20mV/2mV								N/A																																																									
CONSTANT POWER MODE																																																																							
Operating Range		Range		H		M		L		H		M		L																																																									
				17.5W-175W		1.75W-17.5W		0.175W-1.75W		35W-350W		3.5W-35W		0.35W-3.5W		105W-1050W		10.5W-105W		1.05W-10.5W		210W-2100W		21W-210W		2.1W-21W																																													
Accuracy of Setting		H, M		$\pm(0.6\% \text{ of set} + 1.4\% \text{ of f.s.}) + V_{in}/3.24M\Omega$								$\pm(5\% \text{ of f.s.})TYP$																																																											
Resolution		H, M, L		10mW	1mW	0.1mW	10mW	1mW	0.1mW	100mW	10mW	1mW	N/A																																																										
PARALLEL Mode																																																																							
Capacity				875W				1750W				5250W				PEL-3111H with 4 booster units : Max 9.45kW																																																							
SLEW RATE																																																																							
Operation Mode				CC, CR				CC, CR				CC, CR				N/A																																																							
Setting Range (CC mode)		Range		H		M		L		H		M		L		H		M		L		N/A																																																	
				0.14 x N ¹⁰⁰ mA/μs-140mA/μs		0.014 x N ¹⁰⁰ mA/μs-14mA/μs		1.4 x N ¹⁰⁰ μA/μs-1400μA/μs		0.014 x N ¹⁰⁰ mA/μs-14mA/μs		0.0014 x N ¹⁰⁰ mA/μs-1.4mA/μs		0.14 x N ¹⁰⁰ μA/μs-140μA/μs		0.280 x N ¹⁰⁰ mA/μs-280.0mA/μs		0.0280 x N ¹⁰⁰ mA/μs-28.00mA/μs		2.80 x N ¹⁰⁰ μA/μs-2800μA/μs		0.0840 x N ¹⁰⁰ mA/μs-84.00mA/μs		0.00840 x N ¹⁰⁰ mA/μs-8.400mA/μs		N/A																																													
Setting Range (CR Mode)		Range		H		M		L		H		M		L		H		M		L		N/A																																																	
				0.014 x N ¹⁰⁰ mA/μs-14mA/μs		0.0014 x N ¹⁰⁰ mA/μs-1.4mA/μs		0.14 x N ¹⁰⁰ μA/μs-140μA/μs		0.0280 x N ¹⁰⁰ mA/μs-28.00mA/μs		0.00280 x N ¹⁰⁰ mA/μs-2.800mA/μs		0.280 x N ¹⁰⁰ μA/μs-280.0μA/μs		0.0840 x N ¹⁰⁰ mA/μs-84.00mA/μs		0.00840 x N ¹⁰⁰ mA/μs-8.400mA/μs		0.000840 x N ¹⁰⁰ mA/μs-0.8400mA/μs		N/A																																																	
Accuracy of Setting		H, M, L		$\pm(10\% \text{ of set} + 25\mu\text{s})$								N/A																																																											
Resolution (Setting Range)				50 x N ¹⁰⁰ μA		14 x N ¹⁰⁰ mA/μs-140mA/μs		5 x N ¹⁰⁰ μA		1.4 x N ¹⁰⁰ mA/μs-14 x N ¹⁰⁰ mA/μs		0.5 x N ¹⁰⁰ μA		140 x N ¹⁰⁰ μA/μs-1.4 x N ¹⁰⁰ mA/μs		50 x N ¹⁰⁰ nA		14 x N ¹⁰⁰ μA/μs-140 x N ¹⁰⁰ μA/μs		5 x N ¹⁰⁰ nA		1.4 x N ¹⁰⁰ μA/μs-14 x N ¹⁰⁰ μA/μs		0.5 x N ¹⁰⁰ nA		0.14 x N ¹⁰⁰ μA/μs-1.4 x N ¹⁰⁰ μA/μs		100 x N ¹⁰⁰ μA		28 x N ¹⁰⁰ mA/μs-280mA/μs		10 x N ¹⁰⁰ μA		2.8 x N ¹⁰⁰ mA/μs-28 x N ¹⁰⁰ mA/μs		1 x N ¹⁰⁰ μA		280 x N ¹⁰⁰ μA/μs-2.8 x N ¹⁰⁰ mA/μs		0.1 x N ¹⁰⁰ μA		28 x N ¹⁰⁰ μA/μs-280 x N ¹⁰⁰ μA/μs		10 x N ¹⁰⁰ nA		2.8 x N ¹⁰⁰ μA/μs-28 x N ¹⁰⁰ μA/μs		1 x N ¹⁰⁰ nA		0.28 x N ¹⁰⁰ μA/μs-2.8 x N ¹⁰⁰ μA/μs		84 x N ¹⁰⁰ μA		30 x N ¹⁰⁰ μA		8.4 x N ¹⁰⁰ mA/μs-84 x N ¹⁰⁰ mA/μs		0.3 x N ¹⁰⁰ μA		84 x N ¹⁰⁰ μA/μs-840 x N ¹⁰⁰ μA/μs		30 x N ¹⁰⁰ nA		8.4 x N ¹⁰⁰ μA/μs-84 x N ¹⁰⁰ μA/μs		3 x N ¹⁰⁰ nA		0.84 x N ¹⁰⁰ μA/μs-8.4 x N ¹⁰⁰ μA/μs		N/A	
METER																																																																							
Voltmeter		Accuracy		$\pm(0.1\% \text{ of rdg} + 0.1\% \text{ of f.s.})$								$\pm(0.1\% \text{ of rdg} + 0.1\% \text{ of f.s.})TYP$																																																											
Ammeter		Accuracy		$\pm(0.2\% \text{ of rdg} + 0.3\% \text{ of f.s.})$								N/A																																																											
Ammeter(Parallel Operation)		Accuracy		$\pm(1.2\% \text{ of rdg} + 1.1\% \text{ of f.s.})$								$\pm(1.2\% \text{ of rdg} + 1.1\% \text{ of f.s.})TYP$																																																											
DYNAMIC MODE																																																																							
Operation Mode				CC, CR, CP								N/A																																																											
T1 & T2 Accuracy				0.025ms-10ms/Res : 1μs ; 10ms-30s/Res : 1ms								N/A																																																											
Slew Rate (CC Mode)		Range		H		M		L		H		M		L		H		M		L		N/A																																																	
				0.140mA/μs-140.0mA/μs		0.014mA/μs-14.00mA/μs		1.400μA/μs-1400.0μA/μs		0.014mA/μs-14.000mA/μs		0.0014mA/μs-1.4000mA/μs		0.1400μA/μs-140.00μA/μs		0.280mA/μs-280.0mA/μs		0.028mA/μs-28.00mA/μs		2.800μA/μs-2800μA/μs		0.084mA/μs-84.00mA/μs		0.0084mA/μs-8.400mA/μs		N/A																																													
Slew Rate (CR Mode)		Range		H		M		L		H		M		L		H		M		L		N/A																																																	
				0.014mA/μs-14.000mA/μs		0.0014mA/μs-1.4000mA/μs		0.1400μA/μs-140.00μA/μs		0.028mA/μs-28.00mA/μs		2.8μA/μs-2.800mA/μs		0.280μA/μs-280.0μA/μs		0.084mA/μs-84.00mA/μs		0.0084mA/μs-8.400mA/μs		0.00084mA/μs-0.8400mA/μs		N/A																																																	
Current Accuracy				$\pm 0.4\%F.S.$								$\pm 0.4\%F.S.$				$\pm 0.4\%F.S.$																																																							
PROTECTION FUNCTION																																																																							
Functions		Overvoltage protection(OVP), Overcurrent protection(OCP), Overpower protection(OPP), Overheat protection(OHP), Undervoltage protection(UVP), Reverse connection protection(REV)																																																																					
GENERAL																																																																							
Input Range		90VAC-132VAC/180VAC-250VAC Single-phase; 47Hz-63Hz																																																																					
Power(Max.)		90VA				110VA				190VA				230VA																																																									
Interface		Std : USB/RS232/Analog Control ; Opt : GPIB/LAN																																																																					
Dimensions & Weight		213.8(W)x124(H)x400.5(D)mm; Approx. 6kg				213.8(W)x124(H)x400.5(D)mm; Approx. 7kg				427.8(W)x124(H)x400.5(D)mm; Approx. 17kg				427.7(W)x127.8(H)x553.5(D)mm; Approx. 23kg																																																									

Programmable D.C. Electronic Load

SPECIFICATIONS

Model	PEL-3212H	PEL-3323H	PEL-3424H	PEL-3535H	PEL-3322H	PEL-3533H	PEL-3744H	PEL-3955H		
Voltage	0V-800V	0V-800V	0V-800V	0V-800V	0V-800V	0V-800V	0V-800V	0V-800V		
Current	0-105A	0-157.5A	0-210A	0-262.5A	0-157.5A	0-262.5A	0-367.5A	0-472.5A		
Power	2100W	3150W	4200W	5250W	3150W	5250W	7350W	9450W		
Input Resistance	1.62MΩ	1.08MΩ	0.81MΩ	0.648MΩ	3.24MΩ	3.24MΩ	3.24MΩ	3.24MΩ		
Min. Operating Voltage(DC)(Typ.)	5V@105A 2.5V@52.5A	5V@157.5A 2.5V@78.75A	5V@210A 2.5V@105A	5V@262.5A 2.5V@131.25A	5V@157.5A 2.5V@78.75A	5V@262.5A 2.5V@131.25A	5V@367.5A 2.5V@183.75A	5V@472.5A 2.5V@236.25A		
CONSTANT CURRENT MODE										
Operating Range	H,M,L	0-105A 0-10.5A 0-1.05A	0-157.5A 0-15.75A 0-1.575A	0-210A 0-21A 0-2.1A	0-262.5A 0-26.25A 0-2.625A	0-157.5A 0-15.75A 0-1.575A	0-262.5A 0-26.25A 0-2.625A	0-367.5A 0-36.75A 0-3.675A	0-472.5A 0-47.25A 0-4.725A	
Accuracy of Setting	H,M,L	$\pm(0.2\% \text{ of set} + 0.1\% \text{ of f.s.}) + V_{in} / (3.24/N^{10}) M\Omega$								
Resolution	H,M,L	4mA 0.4mA 0.04mA	6mA 0.6mA 0.06mA	8mA 0.8mA 0.08mA	10mA 1mA 0.1mA	6mA 0.6mA 0.06mA	10mA 1mA 0.1mA	14mA 1.4mA 0.14mA	18mA 1.8mA 0.18mA	
CR MODE										
Operating Range ¹⁴	Range	H	21S-360μS (47.619mΩ- 2.778kΩ)	31.5S-540μS (31.746mΩ- 1.85185kΩ)	42S-72μS (23.8095mΩ- 1.3889kΩ)	52.5S-90μS (19.0476mΩ- 1.1111kΩ)	31.5S-540μS (31.746mΩ- 1.85185kΩ)	52.5S-90μS (19.0476mΩ- 1.1111kΩ)	73.5S-1.26mS (13.6054mΩ- 793.651Ω)	94.5S-1.62mS (10.582mΩ- 617.284Ω)
		M	2.1S-36μS (476.19mΩ- 27.778kΩ)	3.15S-54μS (317.46mΩ- 18.5185kΩ)	4.2S-72μS (238.095mΩ- 13.8889kΩ)	5.25S-90μS (190.476mΩ- 11.1111kΩ)	3.15S-54μS (317.46mΩ- 18.5185kΩ)	5.25S-90μS (190.476mΩ- 11.1111kΩ)	7.35S-126μS (136.054mΩ- 793.651kΩ)	9.45S-162μS (105.82mΩ- 6.17284kΩ)
		L	210mS-3.6μS (4.7619Ω- 277.78kΩ)	315mS-5.4μS (3.1746Ω- 185.185kΩ)	420mS-7.2μS (2.38095Ω- 138.888kΩ)	525mS-9μS (1.90476Ω- 111.111kΩ)	315mS-5.4μS (3.1746Ω- 185.185kΩ)	525mS-9μS (1.90476Ω- 111.111kΩ)	735mS-12.6μS (1.36054Ω- 79.365kΩ)	945mS-16.2μS (1.0582Ω- 61.7284kΩ)
Accuracy of Setting ¹⁵	H,M,L	$\pm(0.5\% \text{ of set} + 0.5\% \text{ of f.s.}) + V_{in} / (3.24/N^{10}) M\Omega$: Alone operation specifications								
Resolution		360μS 36μS 3.6μS	540μS 54μS 5.4μS	720μS 72μS 7.2μS	900μS 90μS 9μS	540μS 54μS 5.4μS	900μS 90μS 9μS	1.26mS 126μS 12.6μS	1.62mS 162μS 16.2μS	
CONSTANT VOLTAGE MODE										
Operating Range	Range	H	5V-800V							
		L	5V-80V							
Accuracy of Setting ¹⁷	Range	H,L	$\pm(0.2\% \text{ of set} + 0.2\% \text{ of f.s.})$							
Resolution	Range	H,L	20mV/2mV							
CONSTANT POWER MODE										
Operating Range	Range	H	210W-2100W	315W-3150W	420W-4200W	525W-5250W	315W-3150W	525W-5250W	735W-7350W	945W-9450W
		M	21W-210W	31.5W-315W	42W-420W	52.5W-525W	31.5W-315W	52.5W-525W	73.5W-735W	94.5W-945W
		L	2.1W-21W	3.15W-31.5W	4.2W-42W	5.25W-52.5W	3.15W-31.5W	5.25W-52.5W	7.35W-73.5W	9.45W-94.5W
Accuracy of Setting ¹⁸	H,M,L	$\pm(0.6\% \text{ of set} + 1.4\% \text{ of f.s.}) + V_{in} \times V_{in} / (3.24/N^{10}) M\Omega$: Alone operation specifications								
Resolution		200mW 20mW 2mW	300mW 30mW 3mW	400mW 40mW 4mW	500mW 50mW 5mW	300mW 30mW 3mW	500mW 50mW 5mW	700mW 70mW 7mW	900mW 90mW 9mW	
PARALLEL Mode										
Capacity		-								
SLEW RATE										
Operation Mode		CC, CR		CC, CR		CC, CR		CC, CR		
Setting Range (CC mode)	Range	H	1.68mA/μs-840mA/μs	2.52mA/μs-839.7mA/μs	3.36mA/μs-840mA/μs	4.2mA/μs-840mA/μs	2.52mA/μs-839.7mA/μs	4.2mA/μs-840mA/μs	5.88mA/μs-840mA/μs	7.56mA/μs-839.7mA/μs
		M	168μA/μs-84mA/μs	252μA/μs-83.97mA/μs	336μA/μs-84mA/μs	420μA/μs-84mA/μs	252μA/μs-83.97mA/μs	420μA/μs-84mA/μs	588μA/μs-84mA/μs	756μA/μs-83.97mA/μs
		L	16.8μA/μs-8.4mA/μs	25.2μA/μs-8.397mA/μs	33.6μA/μs-8.4mA/μs	42μA/μs-8.4mA/μs	25.2μA/μs-8.397mA/μs	42μA/μs-8.4mA/μs	58.8μA/μs-8.4mA/μs	75.6μA/μs-8.397mA/μs
Setting Range (CR Mode)	Range	H	168μA/μs-84mA/μs	252μA/μs-83.97mA/μs	336μA/μs-84mA/μs	420μA/μs-84mA/μs	252μA/μs-83.97mA/μs	420μA/μs-84mA/μs	588μA/μs-84mA/μs	756μA/μs-83.97mA/μs
		M	16.8μA/μs-8.4mA/μs	25.2μA/μs-8.397mA/μs	33.6μA/μs-8.4mA/μs	42μA/μs-8.4mA/μs	25.2μA/μs-8.397mA/μs	42μA/μs-8.4mA/μs	58.8μA/μs-8.4mA/μs	75.6μA/μs-8.397mA/μs
		L	1.68μA/μs-840μA/μs	2.52μA/μs-839.7μA/μs	3.36μA/μs-840μA/μs	4.2μA/μs-840μA/μs	2.52μA/μs-839.7μA/μs	4.2μA/μs-840μA/μs	5.88μA/μs-840μA/μs	7.56μA/μs-839.7μA/μs
Accuracy of Setting ¹⁹	H,M,L	$\pm(10\% \text{ of set} + 25\mu\text{s})$								
Resolution (Setting Range)		600μA	900μA	1.2mA	1.5mA	900μA	1.5mA	2.1mA	2.7mA	
		168mA/μs-840mA/μs	252mA/μs-842.4mA/μs	336mA/μs-840mA/μs	420mA/μs-840mA/μs	252mA/μs-842.4mA/μs	420mA/μs-840mA/μs	588mA/μs-840mA/μs	756mA/μs-842.4mA/μs	
		60μA	90μA	120μA	150μA	90μA	150μA	210μA	270μA	
		16.8mA/μs-168mA/μs	25.2mA/μs-252mA/μs	33.6mA/μs-336mA/μs	42mA/μs-420mA/μs	25.2mA/μs-252mA/μs	42mA/μs-420mA/μs	58.8mA/μs-588mA/μs	75.6mA/μs-756mA/μs	
		6μA	9μA	12μA	15μA	9μA	15μA	21μA	27μA	
		1.68mA/μs-16.8mA/μs	2.52mA/μs-25.2mA/μs	3.36mA/μs-33.6mA/μs	4.2mA/μs-42mA/μs	2.52mA/μs-25.2mA/μs	4.2mA/μs-42mA/μs	5.88mA/μs-58.8mA/μs	7.56mA/μs-75.6mA/μs	
		600nA	900nA	1.2μA	1.5μA	900nA	1.5μA	2.1μA	2.7μA	
		0.168mA/μs-1.68mA/μs	0.252mA/μs-2.52mA/μs	0.336mA/μs-3.36mA/μs	0.42mA/μs-4.2mA/μs	0.252mA/μs-2.52mA/μs	0.42mA/μs-4.2mA/μs	0.588mA/μs-5.88mA/μs	0.756mA/μs-7.56mA/μs	
		60nA	90nA	120nA	150nA	90nA	150nA	210nA	270nA	
		0.0168mA/μs-0.168mA/μs	0.0252mA/μs-0.252mA/μs	0.0336mA/μs-0.336mA/μs	0.042mA/μs-0.42mA/μs	0.0252mA/μs-0.252mA/μs	0.042mA/μs-0.42mA/μs	0.0588mA/μs-0.588mA/μs	0.0756mA/μs-0.756mA/μs	
	6nA	9nA	12nA	15nA	9nA	15nA	21nA	27nA		
	0.00168mA/μs-0.0168mA/μs	0.00252mA/μs-0.0252mA/μs	0.00336mA/μs-0.0336mA/μs	0.0042mA/μs-0.042mA/μs	0.00252mA/μs-0.0252mA/μs	0.0042mA/μs-0.042mA/μs	0.00588mA/μs-0.0588mA/μs	0.00756mA/μs-0.0756mA/μs		
METER										
Voltmeter Accuracy		$\pm(0.1\% \text{ of rdg} + 0.1\% \text{ of f.s.})$								
Ammeter Accuracy		$\pm(1.2\% \text{ of rdg} + 1.1\% \text{ of f.s.})$								
DYNAMIC MODE										
Operation Mode		CC and CR								
T1 & T2 Accuracy		0.025ms-10ms/Res : 1μs ; 10ms-30s/Res : 1ms								
Slew Rate (CC Mode)	Range	H	1.68mA/μs-840mA/μs	2.52mA/μs-839.7mA/μs	3.36mA/μs-840mA/μs	4.2mA/μs-840mA/μs	2.52mA/μs-839.7mA/μs	4.2mA/μs-840mA/μs	5.88mA/μs-840mA/μs	7.56mA/μs-839.7mA/μs
		M	168μA/μs-84mA/μs	252μA/μs-83.97mA/μs	336μA/μs-84mA/μs	420μA/μs-84mA/μs	252μA/μs-83.97mA/μs	420μA/μs-84mA/μs	588μA/μs-84mA/μs	756μA/μs-83.97mA/μs
		L	16.8μA/μs-8.4mA/μs	25.2μA/μs-8.397mA/μs	33.6μA/μs-8.4mA/μs	42μA/μs-8.4mA/μs	25.2μA/μs-8.397mA/μs	42μA/μs-8.4mA/μs	58.8μA/μs-8.4mA/μs	75.6μA/μs-8.397mA/μs
Slew Rate (CR Mode)	Range	H	168μA/μs-84mA/μs	252μA/μs-83.97mA/μs	336μA/μs-84mA/μs	420μA/μs-84mA/μs	252μA/μs-83.97mA/μs	420μA/μs-84mA/μs	588μA/μs-84mA/μs	756μA/μs-83.97mA/μs
		M	16.8μA/μs-8.4mA/μs	25.2μA/μs-8.397mA/μs	33.6μA/μs-8.4mA/μs	42μA/μs-8.4mA/μs	25.2μA/μs-8.397mA/μs	42μA/μs-8.4mA/μs	58.8μA/μs-8.4mA/μs	75.6μA/μs-8.397mA/μs
		L	1.68μA/μs-840μA/μs	2.52μA/μs-839.7μA/μs	3.36μA/μs-840μA/μs	4.2μA/μs-840μA/μs	2.52μA/μs-839.7μA/μs	4.2μA/μs-840μA/μs	5.88μA/μs-840μA/μs	7.56μA/μs-839.7μA/μs
Current Accuracy		$\pm 0.4\% \text{ F.S.}$								
PROTECTION FUNCTION										
Functions		Overvoltage protection(OVP), Overcurrent protection(OCP), Overpower protection(OPP), Overheat protection(OHP), Undervoltage protection(UVP), Reverse connection protection(REV)								
GENERAL										
Input Range		90VAC-132VAC/180VAC-250VAC Single-phase; 47Hz-63Hz								
Power(Max.)		380VA	570VA	760VA	950VA	420VA	650VA	880VA	1110VA	
Interface		Std : USB/RS232/Analog Control ; Opt. : GPIB/LAN								
Dimensions & Weight		598(W)x877(H)x 706(D)mm; Approx. 67.5kg	598(W)x877(H)x 706(D)mm; Approx. 85.5kg	598(W)x877(H)x 706(D)mm; Approx. 110kg	598(W)x877(H)x 706(D)mm; Approx. 127.5kg	598(W)x877(H)x 706(D)mm; Approx. 73kg	598(W)x877(H)x 706(D)mm; Approx. 96.5kg	598(W)x877(H)x 706(D)mm; Approx. 125kg	598(W)x877(H)x 706(D)mm; Approx. 149kg	

ORDERING INFORMATION

PEL-3021 (150V/35A/175W) Single-Channel Programmable D.C. Electronic Load
PEL-3041 (150V/70A/350W) Single-Channel Programmable D.C. Electronic Load
PEL-3111 (150V/210A/1050W) Single-Channel Programmable D.C. Electronic Load
PEL-3211 (150V/420A/2100W) 2100W Booster for PEL-3111 only
PEL-3212 (150V/420A/2100W) Single-Channel Programmable D.C. Electronic Load
PEL-3322 (150V/630A/3150W) Single-Channel Programmable D.C. Electronic Load
PEL-3323 (150V/630A/3150W) Single-Channel Programmable D.C. Electronic Load
PEL-3424 (150V/840A/4200W) Single-Channel Programmable D.C. Electronic Load
PEL-3533 (150V/1050A/5250W) Single-Channel Programmable D.C. Electronic Load
PEL-3535 (150V/1050A/5250W) Single-Channel Programmable D.C. Electronic Load
PEL-3744 (150V/1470A/7350W) Single-Channel Programmable D.C. Electronic Load
PEL-3955 (150V/1890A/9450W) Single-Channel Programmable D.C. Electronic Load

PEL-3021H (800V/8.75A/175W) Single-Channel Programmable D.C. Electronic Load
PEL-3041H (800V/17.5A/350W) Single-Channel Programmable D.C. Electronic Load
PEL-3111H (800V/52.5A/1050W) Single-Channel Programmable D.C. Electronic Load
PEL-3211H (800V/105A/2100W) 2100W Booster for PEL-3111H only
PEL-3212H (800V/105A/2100W) Single-Channel Programmable D.C. Electronic Load
PEL-3322H (800V/157.5A/3150W) Single-Channel Programmable D.C. Electronic Load
PEL-3323H (800V/157.5A/3150W) Single-Channel Programmable D.C. Electronic Load
PEL-3424H (800V/210A/4200W) Single-Channel Programmable D.C. Electronic Load
PEL-3533H (800V/262.5A/5250W) Single-Channel Programmable D.C. Electronic Load
PEL-3535H (800V/262.5A/5250W) Single-Channel Programmable D.C. Electronic Load
PEL-3744H (800V/367.5A/7350W) Single-Channel Programmable D.C. Electronic Load
PEL-3955H (800V/472.5A/9450W) Single-Channel Programmable D.C. Electronic Load

ACCESSORIES :

Quick Start Guide, CD(User Manual/Programming Manual), Power Cord
PEL-011 Load Input Terminal Cover **PEL-012** Terminal Fittings Kits

GTL-255 Frame Link Cable 300mm
PEL-013 Flexible Terminal Cover

Front Terminal Washers
PEL-014 J1/J2 Protection Plug

OPTIONAL ACCESSORIES

CR123A 3V Lithium Battery for Clock.	GTL-120 Test Lead (Max. 40A)	PEL-004 GPIB Option	PEL-008 Connect Cu Plate
GRA-413 Rack Mount Bracket for Booster PEL-3211(H) (EIA+JIS)	GTL-248 GPIB Cable, 2.0m	PEL-005 Connect Cu Plate	PEL-009 Connect Cu Plate
GRA-414-E Rack Mount Frame for PEL-3021(H), PEL-3041(H), PEL-3111(H)/EIA	GTL-246 USB Cable Type A- Type B	PEL-006 Connect Cu Plate	PEL-018 LAN Card
GRA-414-J Rack Mount Frame for PEL-3021(H), PEL-3041(H), PEL-3111(H)/JIS	PEL-010 Dust Filter	PEL-007 Connect Cu Plate	

FREE DOWNLOAD

Driver LabView Driver



GRA-413 Rack Mount Kit (EIA+JIS)

For : PEL-3211(H)



GRA-414-J Rack Mount Kit (JIS)

For : PEL-3021/3021H/3041/3041H/3111/3111H



GRA-414-E Rack Mount Kit (EIA)

For : PEL-3021/3021H/3041/3041H/3111/3111H



Programmable D.C. Electronic Load



PEL-3031E



PEL-3032E



FEATURES

- * 0~150V(PEL-3031E) Min. Operating Voltage(dc) : 1V at 60A, 0.5V at 30A
- * 0~500V(PEL-3032E) Min. Operating Voltage(dc) : 2.5V at 15A, 1.25V at 7.5A
- * 7 Operating Modes : CC, CV, CR, CP, CC+CV, CR+CV, CP+CV
- * Normal Sequence Function: Max Steps: 1000 steps/Step Time:1ms~999h 59min 59s(3599940 sec)Fast Sequence Function: Max Steps:1000 steps/Step Time:25us~600ms
- * Soft Start
- * BATT Test Automation:Max Test Time:999h: 59min 59s(3599940 sec):Max Test AH:9999.99Ah
- * OCP, OPP Test Automation
- * Max. Slew Rate : 2.5A/ μ s
- * Dynamic Mode
- * Protection : OVP, OCP, OPP, OTP, RVP, UVP
- * Remote Sense
- * Integrate Voltage, Current and Power Measurement Functions
- * External Voltage or Resistance Control
- * Rear Panel BNC, Trigger IN/OUT
- * Analog External Control
- * USB(Std.)/GPIB & LAN(Opt.)/RS-232 (Manufacturer Installed Only)

GW Instek launches new PEL-3000E series programmable single-channel electronic load. In the series, PEL-3031E provides 300W (1V~150V/60A) and PEL-3032E provides 300W(2.5V~500V/15A) current sink capability. Inherited from the PEL-3000 series, PEL-3000E has an easy-to-read LCD panel and user-friendly interface. This model features high speed and accurate measurement capability for electronic component, battery, portable charger and power products that require low to medium power consumption.

The PEL-3000E series is designed for current sink operation starting from 60mA and aims at measurement applications, including charger, adapter, various power supply equipment, and portable charger.

The PEL-3000E has seven operating modes. Among them, four basic operating modes are constant current, constant voltage, constant resistance, and constant power. Three other combined operating modes are constant current + constant voltage, constant resistance + constant voltage, constant power + constant voltage. Users can select operating modes based upon products' test requirements. For C.C. mode, electronic load will sink a constant current according to the set current value; for C.V. mode, electronic load will attempt to sink sufficient current to control the source voltage to the programmed value; for C.R. mode, electronic load will sink a current linearly proportional to input voltage according to the set resistance value; for C.P. mode, electronic load will initiate load power sinking operation(load voltage x load current) in accordance with the programmed power setting.

To meet the requirements of different test conditions, the Static function is to sink a constant current; the Dynamic function is to periodically switch between two sink conditions, and the Sequence function is to provide tests for more than two sink conditions. The sequence function can be divided into Normal Sequence and Fast Sequence. Normal Sequence is the most flexible mean of generating complex sequences that can facilitate users to establish a set of changing current sink conditions based upon different sinking conditions (CC, CR, CV or CP mode) and time(adjustable range: 1ms to 999h 59min 59s). Fast sequence allows time resolution of 25us to be set for the smallest step. Setting parameters for multiple steps can simulate consecutive current changes of various real load conditions. For instance, while using an electronic load to test a power-driven tool's power supply, we can first obtain waveforms by an oscilloscope and a current probe from the tool, and subsequently, use the obtained waveforms to edit simulated current waveforms, via electronic load's sequence function, to test the power-driven tool and to analyze its operational status. The Soft Start function allows users to determine the rise time of current sink that is to decide the required time to reach electronic load's set current, resistance or power value. Setting a proper rise time for Soft Start is effective to counter output voltage fluctuation caused by DUT's (power supply) transient output current. It is worth noting, General DC loads do not have the soft start function. When conducting high speed current sink operation, the inductance effect on the cable connecting electronic load and DUT will lead to transient voltage drop on electronic load's input terminal, therefore, that will result in Voltage Non-monotonic increase. PEL-3000E's soft start function not only allows output voltage to be Monotonic increase, but also prevents inrush current and surge voltage from happening on DUT. For instance, tests using a power supply, LED and a DC load (activate the soft start function) can prevent inrush current and surge voltage from causing damages on LED.

The built-in BATT Test Automation of PEL-3000E provides battery discharge applications with more flexible discharge stop setting as well as rise and fall Slew Rate for discharge current settings. OCP, OPP test Automation for DUT (ex. Power Supply), provide users with high resolution measurement values to verify DUT's activation point. Provide users with measurement results so as to help them determine whether DUT's actual over protection activation point meets the regulations. Other than that, PEL-3000E provides users with analog control terminal to control PEL-3000E from external voltage, external resistance and switch. Analog control terminal can also monitor electronic load's status and display protective alarms.

SPECIFICATIONS				
Model	PEL-3031E		PEL-3032E	
Power Range	300W Low	300W High	300W Low	300W High
Voltage	0 - 150V	0 - 150V	0 - 500V	0 - 500V
Current	0 - 6A	0 - 60A	0 - 1.5A	0 - 15A
Min. Operating Voltage(dc)	1V - 6A	1V - 60A	2.5V - 1.5A	2.5V - 15A
STATIC MODE				
Constant Current Mode Range	0 - 6A	0 - 60A	0 - 1.5A	0 - 15A
Setting Range	0 - 61.2A	0 - 61.2A	0 - 1.53A	0 - 15.3A
Resolution	0.2mA	2mA	0.05mA	0.5mA
Accuracy	(T [±])±(0.1% of set +0.1% of FS)+ Vin/500k Ω (Full scale of High range)	(T [±])±(0.1% of set +0.2% of FS)+ Vin/500k Ω (Full scale of High range)	(T [±])±(0.1% of set +0.1% of FS)+ Vin/500k Ω (Full scale of High range)	(T [±])±(0.1% of set +0.2% of FS)+ Vin/500k Ω (Full scale of High range)
Constant Resistance Mode Range	60S-0.002S(0.01666 Ω -500 Ω)(300W/15V)	6S-0.0002S(0.1666 Ω -5k Ω)(300W/150V)	6S-0.0002S(0.1666 Ω -5k Ω)(300W/500V)	6S-0.0002S(0.1666 Ω -5k Ω)(300W/500V)
Setting Range	60S-0.002S(0.01666 Ω -500 Ω)(300W/15V)	6S-0.0002S(0.1666 Ω -5k Ω)(300W/150V)	6S-0.0002S(0.1666 Ω -5k Ω)(300W/500V)	6S-0.0002S(0.1666 Ω -5k Ω)(300W/500V)
Resolution(30000 Steps)	0.002S(15V) ; 0.0002S(150V)	0.0002S(15V) ; 0.00002S(150V)	0.0002S(50V) ; 0.00002S(500V)	0.0002S(50V) ; 0.00002S(500V)
Accuracy	(T [±])±(0.3% of set + 0.6S) + 0.002mS	(T [±])±(0.3% of set + 0.6S) + 0.002mS	(T [±])±(0.3% of set + 0.06S) + 0.002mS	(T [±])±(0.3% of set + 0.06S) + 0.002mS
Constant Voltage Mode Range	1 - 15V	1 - 150V	2.5 - 50V	2.5 - 500V
Setting Range	0 - 15.3V	0 - 153V	0 - 51V	0 - 510V
Resolution	0.5mV	5mV	1mV	10mV
Accuracy	(T [±])±(0.1% of set+ 0.1% of FS) (Full scale of High range)	(T [±])±(0.1% of set+ 0.1% of FS) (Full scale of High range)	(T [±])±(0.1% of set+ 0.1% of FS) (Full scale of High range)	(T [±])±(0.1% of set+ 0.1% of FS) (Full scale of High range)
Constant Power Mode Range	0W - 30W(6A)	0W - 300W(60A)	0W - 30W(1.5A)	0W - 300W(15A)
Setting Range	0W - 30.6W	0W - 306W	0W - 30.6W	0W - 306W
Resolution	1mW	10mW	1mW	10mW
Accuracy	(T [±])±(0.6 % of set + 1.4 % of FS (Full scale of H range) + Vin \wedge 2/500 k Ω)			

PEL-3031E/3032E

DC ELECTRONIC LOADS



PEL-3032E

Rear Panel



SPECIFICATIONS				
Model	PEL-3031E		PEL-3032E	
DYNAMIC MODE				
General	0.05ms-30ms/Res:1μs;30ms-30s/Res:1ms		0.05ms-30ms/Res:1μs;30ms-30s/Res:1ms	
T1& T2	1μs/1ms±200ppm		1μs/1ms±200ppm	
Accuracy	1μs/1ms±200ppm		1μs/1ms±200ppm	
Slew Rate(Accuracy 10%)	0.001 - 0.25A/μs		0.25 - 62.5mA/μs	
Slew Rate Resolution	0.001A/μs		0.25mA/μs	
Slew Rate Accuracy of Setting	±(10% + 15μs) *1 Time to reach from 10% to 90% when the current is varied from 2% to 100% (20% to 100% in L range) of the rated current.			
Constant Current Mode	0 - 6A		0 - 1.5A	
Current	0 - 60A		0 - 15A	
Setting Range	0 - 6.12A		0 - 1.53A	
Current Resolution	0.2mA		0.05mA	
Current Accuracy	±0.8% FS		±0.8% FS	
Constant Resistance Mode	60S-0.002S(0.1666Ω-500Ω)(300W/15V)		6S-0.0002S(0.1666Ω-5kΩ)(300W/50V)	
Range	6S-0.0002S(0.1666Ω-5kΩ)(300W/150V)		0.6S-0.00002S(1.6666Ω-50kΩ)(300W/500V)	
Setting Range	60S-0.002S(0.1666Ω-500Ω)(300W/15V)		6S-0.0002S(0.1666Ω-5kΩ)(300W/50V)	
Resistance Resolution	6S-0.0002S(0.1666Ω-5kΩ)(300W/150V)		0.6S-0.00002S(1.6666Ω-50kΩ)(300W/500V)	
Resistance Accuracy	30000 steps		30000 steps	
	(T [±])±(1%set + 0.6S) + 0.002mS		(T [±])±(1%set + 0.06S) + 0.002mS	
MEASUREMENT				
Voltage Readback	0 - 15V		0 - 50V	
Range	0 - 150V		0 - 500V	
Resolution	0.5mV		2mV	
Accuracy	(T [±])±(0.1% of rdg + 0.1% of FS)		(T [±])±(0.1% of rdg + 0.1% of FS)	
	(Full scale of Low range)		(Full scale of Low range)	
	(Full scale of High range)		(Full scale of High range)	
Current Readback	0 - 6A		0 - 1.5A	
Range	0 - 60A		0 - 15A	
Resolution	0.2mA		0.05mA	
Accuracy	(T [±])±(0.1% of rdg+ 0.1% of FS)		(T [±])±(0.1% of rdg+ 0.1% of FS)	
	(Full scale of High range)		(Full scale of High range)	
Power Read back H&L Range	0 - 300W		0 - 300W	
CP Mode L Range	0 - 30W		0 - 30W	
FUNCTION				
Sequence(Normal/Fast)	Normal sequence function: Max steps: 1000 steps/Step time: 1ms - 999h 59min 59s(3599940 sec)			
	Fast sequence function: Max steps: 1000 steps/Step time: 25us - 600ms			
BATT Test Automation	Max test time: 999h: 59m: 59s(3599940sec)			
	Max test AH: 9999.99Ah			
Test Function	OCP Autotest function, OPP Autotest Function			
Soft Start	Yes			
In/Out Terminal	Analog External Control, Current Monitor Output, Trigger In/Out Terminal(BNC)			
Preset Data	10 Sets			
Protection	OCP, OPP, UVP, OVP, OTP, RVP			
OTHER				
Power Source	100 - 120VAC/200 - 240VAC, 47 - 63Hz			
Interface	USB(Std.)/GPIB & LAN(Opt.)/RS-232(Manufacturer Installed Only)			
Dimensions & Weight	213.8(W) x 124.0(H) x 400.5(D)mm, Approx. 7.5Kg			

Note : *1 - If the ambient temperature is over 30 °C or below 20 °C, then T = ± |t - 25 °C| x 100ppm/°C x Set
If the ambient temperature is in the range of 20°C-30°C, then T = 0 (t is the ambient temperature)

ORDERING INFORMATION

PEL-3031E 150V/60A/300W Programmable Single-channel D.C. Electronic Load
PEL-3032E 500V/15A/300W Programmable Single-channel D.C. Electronic Load

ACCESSORIES :

Quick Start Guide, CD ROM (User Manual, Programming Manual)x1, Power Cord (Region dependent), Front Terminal Washers-spring Washer(M6)x2, GTL-105A Remote Sense Cables(Red x 1, Black x 1)

OPTIONAL ACCESSORIES

GTL-248 GPIB Cable, 2m	PEL-010 Dust Filter	GRA-414-J Rack Mount Kit (JIS)
GTL-246 USB Cable, Type A - Type B	PEL-004 GPIB Option	GRA-414-E Rack Mount Kit (EIA)
PEL-018 LAN Card		

PEL-010 Dust Filter



PEL-004 GPIB Option



PEL-018 LAN Card



GRA-414-J Rack Mount Kit (JIS)

For : PEL-3031E/3032E



GRA-414-E Rack Mount Kit (EIA)

For : PEL-3031E/3032E



PEL-3031E/3032E

DC ELECTRONIC LOADS

Programmable D.C. Electronic Load

A. OPERATING MODE

The PEL-3000E series provides four fundamental operating modes and three add-on modes of CC, CR and CP separately combining with CV. Users can set different load condition under different operating modes such as setting operating range for load level, Current Slew Rate, input voltage and load current. The input

voltage range has two levels - high and low. The load current operating range has two levels - high and low current levels which possess different resolution to meet test requirements of different power product specifications.

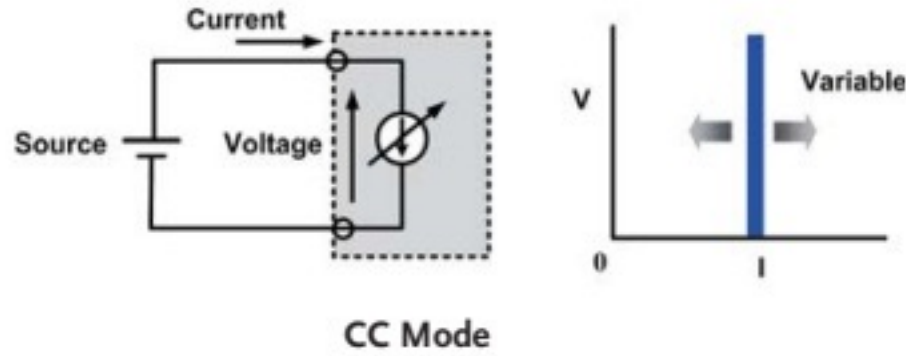

Under constant current mode, electronic load will sink the amount of current users has set. Different current settings via CC mode allow users to test the voltage changes of DC power supply which is called load regulation test.

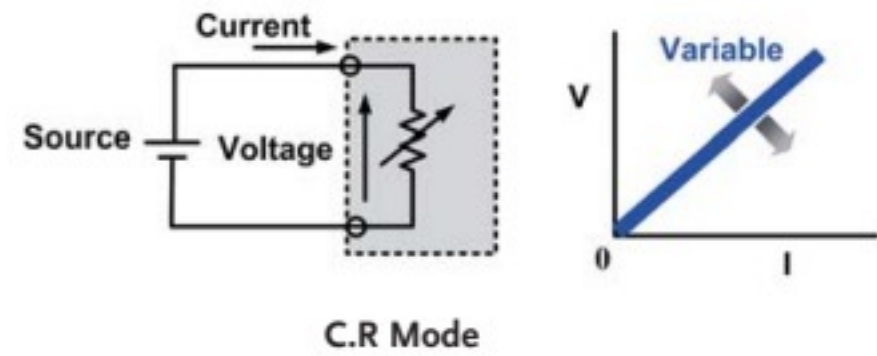

Under constant resistance mode, electronic load will sink load current, which is linearly direct proportion to input voltage. This mode can be utilized in testing voltage or the activation and current limit of power supply.

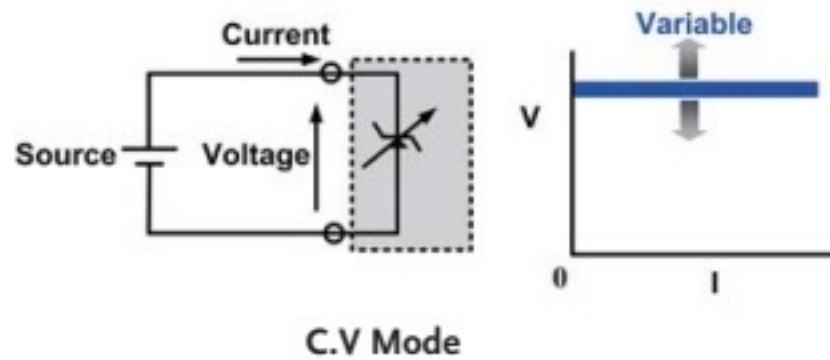

Under constant voltage mode, electronic load will sink sufficient current to regulate the voltage source to the set value. This mode allows users not only to test current limit function of power supply, but also to simulate battery operation in testing battery chargers.

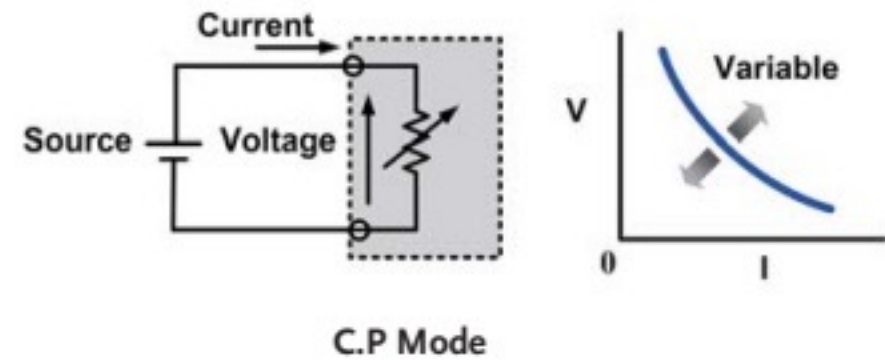

Under constant power mode, electronic load will sink load current, which is indirect proportion to input voltage to reach preset constant power requirement. Hence, the changes of input voltage will have indirect proportion effect on current sinking so as to reach constant power control.

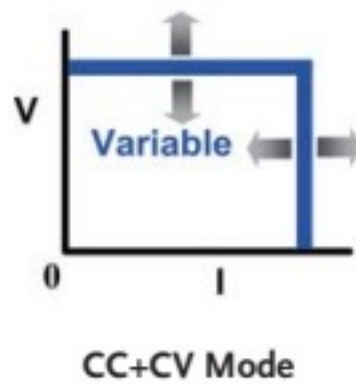

+CV mode can be selected under CC, CR or CP mode. When +CV mode function is turned on and electronic load sinks more current than the maximum current of power supply under test, electronic load will automatically switch to CV mode. It is because that the current sunk is the maximum current of power device. Therefore,

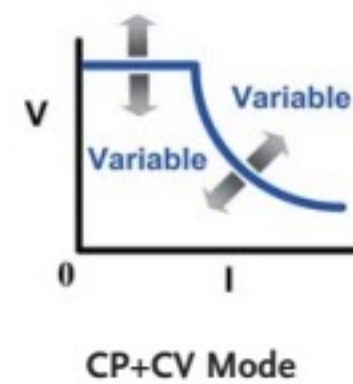
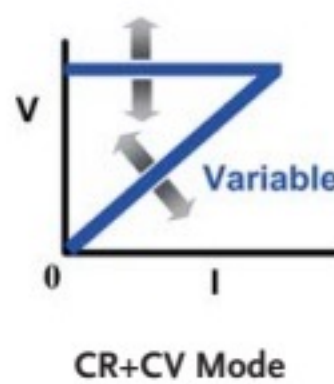

power supply will switch to CC mode and PEL-3000 will switch to CV mode to limit electronic load from sinking the total current of power supply so as to prevent power supply under test from damaging. Electronic load will cease operation once the voltage of DUT is lower than the set voltage under +CV mode.

B. STATIC/DYNAMIC/SEQUENCE MODE

Operation Function	Static	Dynamic	Sequence	
			Fast	Normal
Operating Condition Selection	Single fixed condition	Selection between two conditions	Selection from more than two conditions	Selection from more than two conditions
Operating Modes	All modes	<ul style="list-style-type: none"> Two conditions using same mode Support CC or CR 	<ul style="list-style-type: none"> Each condition must use same mode Support CC or CR mode 	<ul style="list-style-type: none"> Each condition is able to be used in different mode All modes
Adjustable Condition Setting	<ul style="list-style-type: none"> Value A/ Value B Slew Rate 	<ul style="list-style-type: none"> Level 1/Level 2 Timer 1/Timer 2 Slew Rate 1/Slew Rate 2 	<ul style="list-style-type: none"> Level Timer Slew Rate Others... 	<ul style="list-style-type: none"> Level Timer Slew Rate Others...
Sequence Step Combination	N/A	N/A	<ul style="list-style-type: none"> 1 Sequence 1,000 steps 25µs/step 	<ul style="list-style-type: none"> 10 Sequence 1,000 steps 1ms/step
Other Functions	N/A	Trigger Out function	Trigger Out function	<ul style="list-style-type: none"> Trigger Out function Ramp function

The PEL-3000E series, according to different test conditions, step or continuous changes, test speeds, and selectable modes, has three operating functions: Static, Dynamic and Sequence.

C. FAST SEQUENCE & NORMAL SEQUENCE

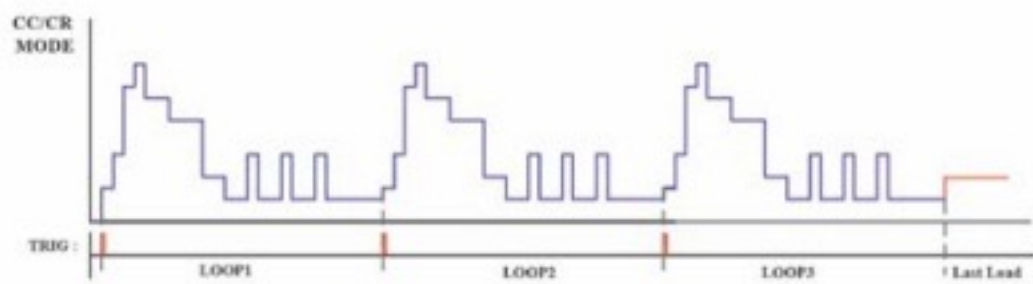

Fast Sequence Diagram



Normal Sequence Diagram

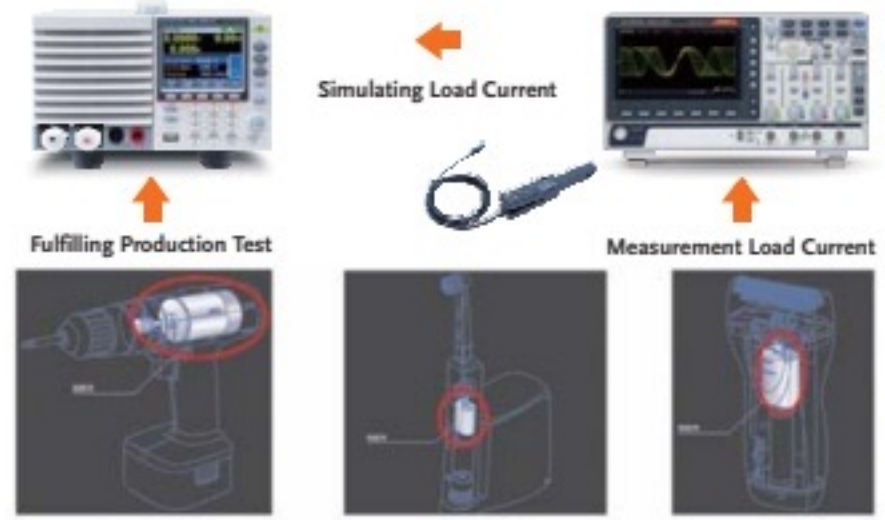

Power-driven Tools Simulation Test

Set a complete sequence editing function to obtain following waveforms. Users can save development cost and time without using a PC to control electronic load and writing programs.

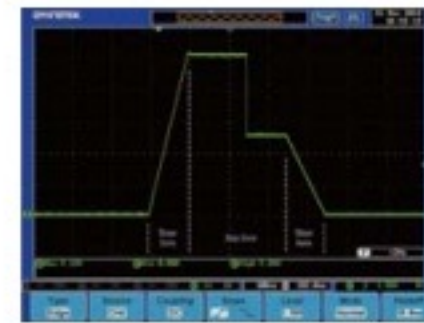
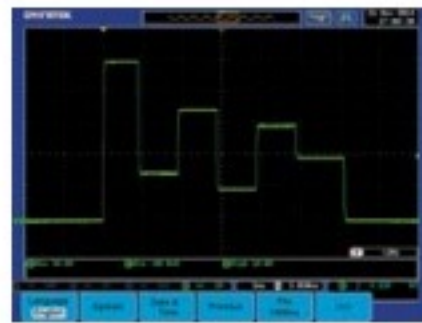

When operating the Sequence Function, PEL-3000E Series follows the time and load settings of step1, step2, step3, etc. so as to realize different load current variation.

Ramp function of PEL-3000E Series is able to set the current transition. When turned on, the current takes on a slope form; when turned off, the current takes on a step form.

D. SOFT START

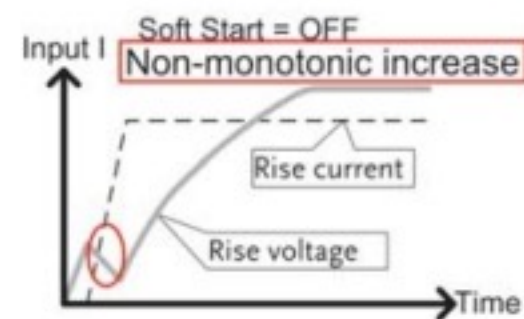
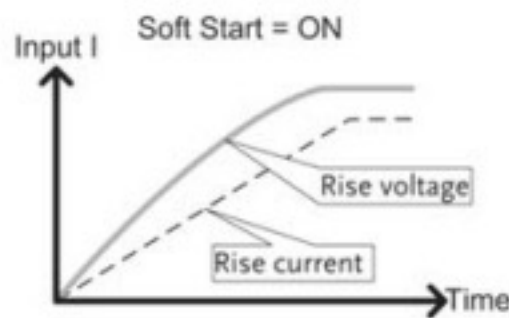

The Soft Start function of PEL-3000E Series allows users to determine the rise time of current sink that is to decide how much time is required to reach electronic load's set current, resistance or power value. PEL-3000E's soft start function prevents inrush current and surge voltage from happening on DUT.

For instance, test applications using a power supply, LED and a DC load (activate the soft start function) can prevent inrush current and surge voltage from causing damages on LED.

E. BATT TEST AUTOMATION

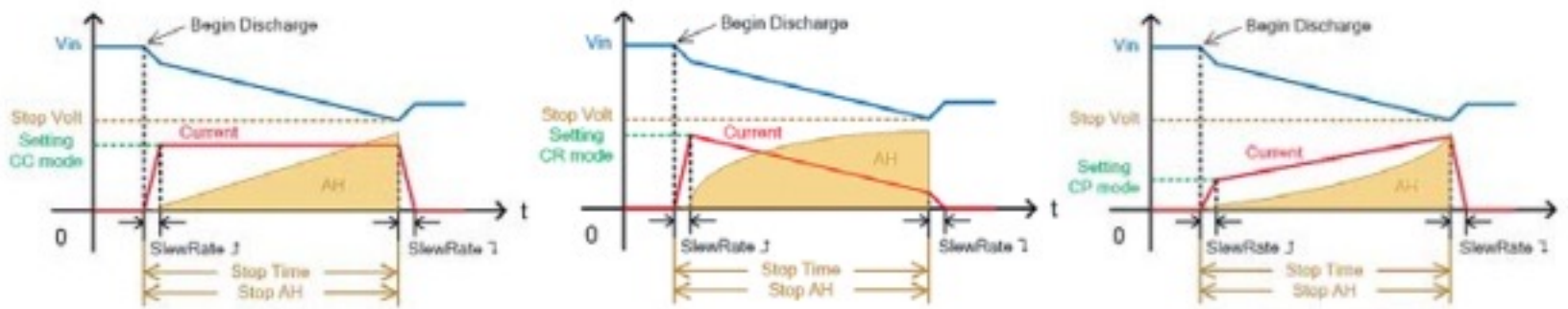

CC Mode

CR Mode

CP Mode

BATT Test Automation Editing



The built-in BATT Test Automation of PEL-3000E provides battery discharge applications with more flexible discharge stop condition setting as well as rise and fall Slew Rate for discharge current settings. Under CP, CC or CR mode, the

conditions for stop discharge can be set respectively. For instance, set the input voltage for stop discharge current, the execution time for discharge current or total discharge current*time(AH) to satisfy the verification of battery capability.

Programmable D.C. Electronic Load

F. OCP TEST AUTOMATION

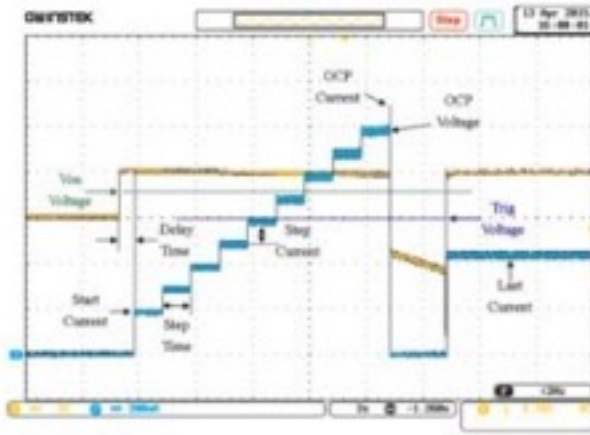

OCP test Automation for DUT(Power Supply), Provide users with high resolution OCP measurement values to verify DUT's OCP activation point. Provide users with measurement results so as to help them determine whether DUT's actual OCP activation point meets the regulations. Test the value of OCP by setting load current increment from start current to stop current. OCP's activation point can be accurately measured.

G. OPP TEST AUTOMATION

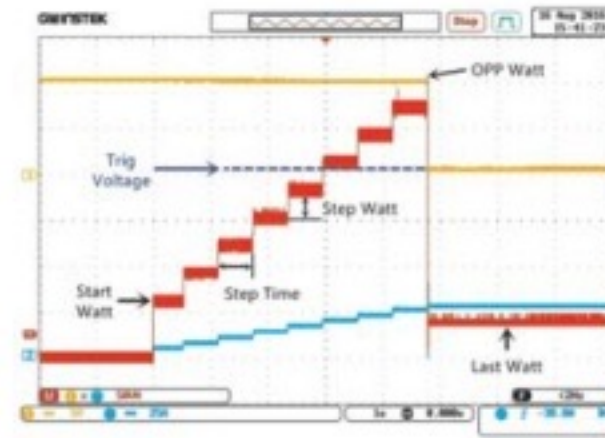

OPP test Automation for DUT(Power Supply), Provide users with high resolution OPP measurement values to verify DUT's OPP activation point. Provide users with measurement results so as to help them determine whether DUT's actual OPP activation point meets the regulations. Test the value of OPP by setting power increment from start power to stop power. OPP's activation point can be accurately measured.

H. TRIGGER IN/OUT BNC

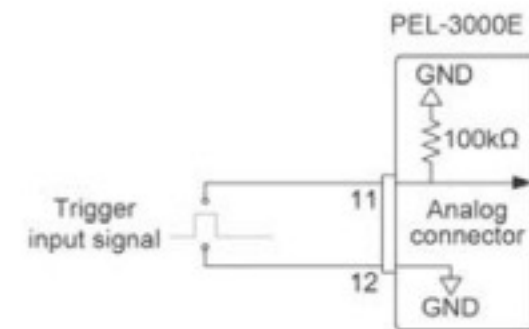
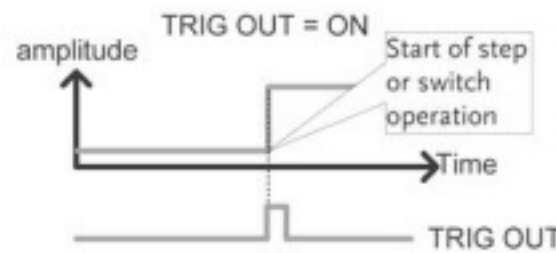

Trigger In/Out function could be turned on or off by CONFIGURE setting of PEL-3000E. The Trigger Input can be set the delay time while the Trigger Out Pulse Width can be set as well.

The trigger output signal is generated every time a switching operation is performed such as Dynamic mode or Fast/Normal sequence is executed when the trig out parameter is enabled. The trigger output signal from TRIG OUT BNC is a 4.5V pulse of at least 2us with an impedance of 500ohm. The common

potential is connected to the chassis potential. The signal threshold level is TTL.

The TRIG IN BNC on the rear panel is used to resume a sequence after a pause. This action is useful to synchronize the execution of a sequence with another device. To resume a pause sequence, apply a high signal for 10us or more. The TRIG IN BNC is pulled down to earth internally using a 100Kohm resistor.

I. PROTECTION MODES

Function \ Protection	OCP	OVP	OPP	OTP	UVP
Adjustable Thresholds	✓	✓	✓	N/A	✓
Load Off	✓	✓	✓	Fixed	✓
Limit Function	✓	N/A	✓	N/A	N/A

The PEL-3000E series provides many protective functions including over current protection (OCP), over voltage protection (OVP), over power protection (OPP), over temperature protection (OTP) and under voltage protection (UVP). Except for OTP, all thresholds

of protective functions are adjustable. When protective function is activated, electronic load will send out warning signal and terminate operation. Other than protective functions, Limit function can also be utilized to maintain electronic load in operation at a preset value.

J. ANALOG EXTERNAL CONTROL

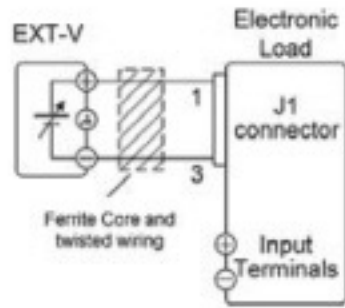

External Voltage Control

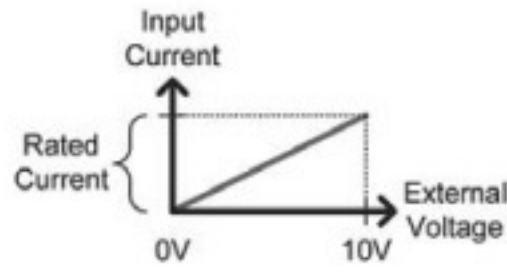

CC Mode

$$\text{Input current} = \text{rated current} \times (\text{external voltage}/10)$$

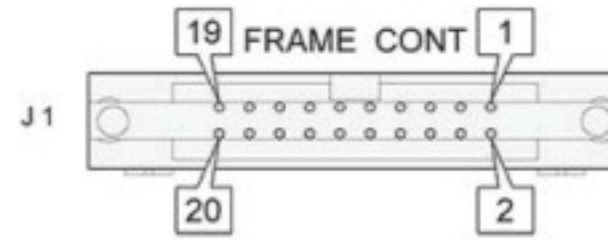

J1 Connector

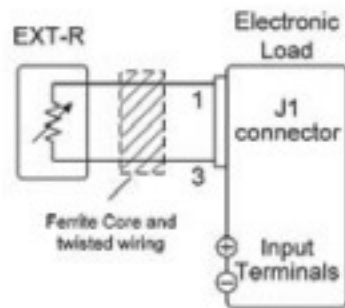

External Resistance Control

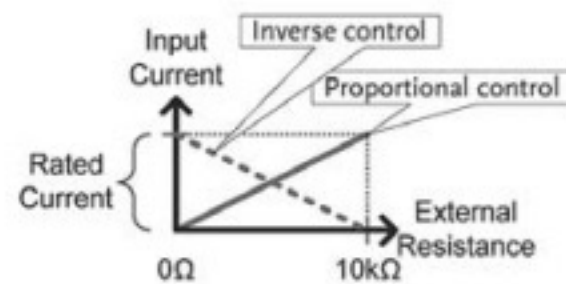

CC Mode

$$\text{Proportional Control: Input current} = \text{rated current} \times (\text{external resistance}/10\text{K ohm})$$

$$\text{Inverse Control: Input current} = \text{rated current} \times (1 - \text{external resistance}/10\text{k ohm})$$

The PEL-3000E series provides the external analog channel control function, which allows users to connect J1 connectors on the rear panel to input voltage or to connect resistance to control electronic load operation. Users can integrate this function into test system and utilize signals generated from the test system to control PEL-3000E.

K. VonN VOLTAGE AND Von LATCH FUNCTION

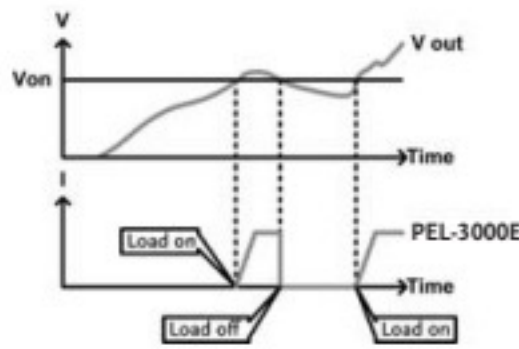

Von Latch = OFF

Von Voltage is the threshold voltage for electronic load to activate or terminate sinking current. When Von Latch is set to off, electronic load operation will be activated if input voltage is higher than Von Voltage and electronic load operation will be terminated if input voltage is lower than Von Voltage. When Von

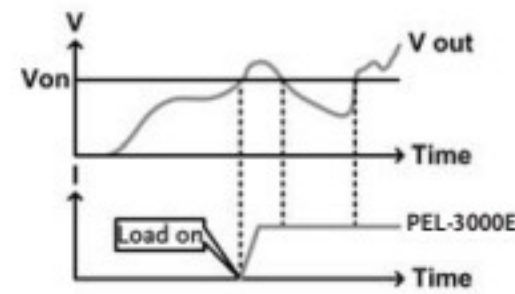

Von Latch = ON

Latch is set to on, electronic load operation will be activated if input voltage is higher than Von Voltage and will continue operation even input voltage is lower than Von Voltage. Von Voltage function can test the transient maximum current capability provided by power supply.

L. TIMER FUNCTIONS



Elapsed Time

The PEL-3000E series provides count time and cut off time functions. The display screen will show present activation time when electronic load is activated. When electronic load operation is terminated count time will stop and the total operation time will be shown on the display screen.

The activation time of cut off time can be set to the maximum length of 999h 59min 59s. When electronic load is activated



Voltage at Cut Off Time

this function will start counting time. Electronic load will cease operation (load off) and show the final input voltage on the screen when preset time is reached. Timer function can provides information and application related to time. Users can obtain the total time of limiting electronic load operation to increase the agility of electronic load tests.

Programmable D.C. Electronic Load



PEL-2004A(B)

NEW



PEL-2002A(B)

NEW



FEATURES

- Sequence Function to do High Speed Load Simulations
- Flexible Configuration with Mainframes and Plug-in Modules
- Multiple Independent Load Inputs up to 8 Channels in a Mainframe
- Parallel Connection of Inputs for Higher Load Capacity
- Program Mode to Create Work Routines for Repetitive Tests
- OPP/OCV/OVP/OTP/RVP/UV Protection
- External Channel Control/Monitoring via Analog Control Connector
- PEL-2000A Series Interface Standard : USB, RS-232; Option : LAN, GPIB
- PEL-2000B Series Interface Standard : USB, RS-232, LAN; Option : GPIB

The PEL-2004A(B) and PEL-2002A(B) are multiple channel, programmable DC electronic loads with a modularized structure. The PEL-2000A(B) Series is designed to meet the continuing shift toward high speed operation in today's semiconductor market. As the power supply units, DC-DC converters, and batteries that drive semiconductor circuits need to follow this shift, power supply design, quality inspection and characteristic certification using high-speed performance loads have become necessary. The PEL-2000A(B) Series includes two types of mainframes and 4 types of load modules to accommodate users' requirements in a flexible manner. Any load module combination can be used with a mainframe to tailor a test system based on the number of channels, and the maximum load power, voltage and current of each channel. Multiple loads can be connected in parallel to provide a higher-power load to test higher power supply outputs. This flexibility significantly reduces the investment needed for future projects that have differed power requirements.

PEL-2004A(B) is a 4-slot mainframe with a master control unit to hold 4 load modules, while PEL-2002A(B) is a 2-slot mainframe with master control unit to hold 2 load modules. When PEL-2004A(B) is configured with 4 load modules rated at 350W each, the PEL-2000A(B) Series is able to sink up to 1.4kVA of power.

For higher load capacities, mainframes can be linked together in parallel with standard MIL-20-pin connectors. A maximum of 5 mainframes, including one master and 4 slaves can be chained together to create a total load capacity of 7kW for high current and high power applications. Using 4 dual channel load modules, PEL-2004A(B) is able to test 8 power supply outputs simultaneously.

The Sequence function allows each channel to change its load sink according to a predefined sequence at a rate of up to 100µs per step. Each sequence is able to run concurrently, under the control of one clock. This is one of the most powerful features of the PEL-2000A(B) Series as it is able to realistically simulate a multi-output power supply load. Under Dynamic mode, the load current or load resistance pulses between two preset levels at a pre-defined speed up to 25µs per step. This is often used as the standard test procedure to verify the response of a power supply to quick load changes. Most remarkably, multiple load channels can be connected in parallel to run Dynamic tests synchronously under a single clock. This Parallel Dynamic functionality gives the flexibility to perform dynamic tests for a high-power power supply without the need of another high-power load.

The PEL-2000A(B) Series includes a number of protection modes: Over Current Protection (OCP), Over Voltage Protection (OVP), Over Power Protection (OPP), Reverse Voltage Protection (RVP), and Under Voltage Protection (UV). The protection modes are useful to protect both the load modules and the DUT(s).

A buzzer can be set for when a protection setting has been tripped. When a protection mode has been tripped, the load unit will display an alarm and stop sinking current/voltage. When a load unit is operating in CR or CV mode, the unit may need Over Current Protection to prevent excessive current being sunk. Over Current Protection stops the load from sinking more current than its recommended limit and prevents the load from burn-out damage. Over Voltage Protection is used to limit the amount of voltage sunk. If the OVP trips, the PEL-Series load will stop sinking voltage. Over Power Protection is used when the input power exceeds the specifications of the load. When OPP is tripped, the power will cease to be sunk. Reverse Voltage Protection prevents reverse voltage damage to the PEL-2000A(B) Series up to the specified rating. When Reverse Voltage Protection has been tripped, an alarm tone will sound until the reverse voltage is removed. Under Voltage Protection will turn off the load when the voltage drops below a set limit.

The Go/NoGo function is available to monitor test results all the time. When a test result goes beyond a preset limit range, a "No Go" indication will be shown on the display and a "No Go" signal can be sent out through the D-SUB interface for external device control. This Go/NoGo function is available for CC mode, CV mode and CR mode. Under "Program" mode, 12 programs each containing 10 panel-setup memories, can be edited to create work routines for repetitive tests. After a program has been executed, the results of all test steps, along with the Go/NoGo judgments, will be shown on the screen. For external control and system configuration, the PEL-Series has USB and RS-232 interfaces as standard and LAN as well as GPIB as an option. The LabView driver and Data Logging PC software are both supported for all the available interfaces. Each channel has an analog control/monitoring connector on the rear panel to externally turn a load on/off and to externally monitor load input current and voltage.

PEL-001 GPIB Card



GTL-249 Frame Link Cable



PEL-002 Rack Mount Kit



GTL-120 Test Lead



PEL-003 Panel Cover



GTL-121 Sense Lead



PEL-016 LAN Card
(for PEL-2000A Main Frame)



SPECIFICATIONS

	PEL-2020A(B)		PEL-2030A(B)			PEL-2040A(B)		PEL-2041A(B)			
CHANNEL	L/R	L/R	Left	Right	Right	one channel	one channel	one channel	one channel		
RANGE	LOW	HIGH	N/A	LOW	HIGH	LOW	HIGH	LOW	HIGH		
POWER	100W	100W	30W	250W	250W	350W		350W			
CURRENT	0-2A	0-20A	0-5A	0-4A	0-40A	0-7A	0-70A	0-1A	0-10A		
VOLTAGE	0-80V		0-80V			0-80V		0-500V			
MIN. OPERATING VOLTAGE(dc)(Typ.)	0.4V at 2A 0.2V at 1A	0.8V at 20A 0.4V at 10A	0.8V at 5A 0.4V at 2.5A	0.4V at 4A 0.2V at 2A	0.8V at 40A 0.4V at 20A	0.4V at 7A 0.2V at 3.5A	0.8V at 70A 0.4V at 35A	1V at 1A 0.5V at 0.5A	2V at 10A 1V at 5A		
STATIC MODE											
CONSTANT CURRENT MODE											
	Operating Range	0-2A	0-20A	0-5A	0-4A	0-40A	0-7A	0-70A	0-1A	0-10A	
	Setting Range	0-2.04A	0-20.4A	0-5.1A	0-4.08A	0-40.8A	0-7.14A	0-71.4A	0-1.02A	0-10.2A	
	Resolution	0.1mA	1mA	0.125mA	0.1mA	1mA	0.2mA	2mA	0.05mA	0.5mA	
	Accuracy	±(0.1%set + 0.1%F.S. ¹)	±(0.1%set + 0.2%F.S.)	±(0.1%set + 0.1%F.S.)	±(0.1%set + 0.1%F.S. ¹)	±(0.1%set + 0.2%F.S.)	±(0.1%set + 0.1%F.S. ¹)	±(0.1%set + 0.2%F.S.)	±(0.1%set + 0.1%F.S. ¹)	±(0.1%set + 0.2%F.S.)	
CONSTANT RESISTANCE MODE											
	Operating Range	0.075Ω-300Ω(100W/16V) 3.75Ω-15kΩ(100W/80V)	0.3Ω-1.2kΩ(30W/16V) 15Ω-60kΩ(30W/80V)	0.0375Ω-150Ω(250W/16V) 1.875Ω-7.5kΩ(250W/80V)	0.025Ω-100Ω(350W/16V) 1.25Ω-5kΩ(350W/80V)	1.25Ω-5kΩ(350W/125V) 50Ω-200kΩ(350W/500V)					
	Setting Range	0.075Ω-300Ω(100W/16V) 3.75Ω-15kΩ(100W/80V)	0.3Ω-1.2kΩ(30W/16V) 15Ω-60kΩ(30W/80V)	0.0375Ω-150Ω(250W/16V) 1.875Ω-7.5kΩ(250W/80V)	0.025Ω-100Ω(350W/16V) 1.25Ω-5kΩ(350W/80V)	1.25Ω-5kΩ(350W/125V) 50Ω-200kΩ(350W/500V)					
	Resolution ¹	0.333mS(100W/16V) 6.667μS(100W/80V)	83.333μS(30W/16V) 1.666μS(30W/80V)	0.666mS(250W/16V) 13.333μS(250W/80V)	1mS(350W/16V) 20μS(350W/80V)	20μS(350W/125V) 0.5μS(350W/500V)					
	Accuracy ²	3000 : ±(0.2%set + 0.1S)	1.2kΩ : ±(0.2%set + 0.1S)	1500 : ±(0.2%set + 0.1S)	1000 : ±(0.2%set + 0.1S)	5kΩ : ±(0.2%set + 0.02S)					
	With ≥2.5V at input	15kΩ : ±(0.1%set + 0.01S)	60kΩ : ±(0.1%set + 0.01S)	7.5kΩ : ±(0.1%set + 0.01S)	5kΩ : ±(0.1%set + 0.01S)	200kΩ : ±(0.1%set + 0.005S)					
NOTE : ¹ : S (siemens) is the unit of conductance, equal to one reciprocal ohm. ² : Accuracy must be calculated in conductivity units.											
CONSTANT VOLTAGE + CONSTANT CURRENT MODE											
	Operating Range	1-80V	1-16V	1-80V	1-16V	1-80V	1-16V	1-80V	1-16V	2.5-500V	2.5-125V
	Setting Range	0-81.6V	0-16.32V	0-81.6V	0-16.32V	0-81.6V	0-16.32V	0-81.6V	0-16.32V	0-510V	0-127.5V
	Resolution	2mV	0.4mV	2mV	0.4mV	2mV	0.4mV	2mV	0.4mV	10mV	2.5mV
	Accuracy	±(0.05%set + 0.1%F.S.)		±(0.05%set + 0.1%F.S.)		±(0.05%set + 0.1%F.S.)		±(0.05%set + 0.1%F.S.)		±(0.05%set + 0.1%F.S.)	
	Current Setting Range	0-2.04A	0-20.4A	0-5.1A	0-4.08A	0-40.8A	0-7.14A	0-71.4A	0-1.02A	0-10.2A	
	Resolution	0.1mA	1mA	0.125mA	0.1mA	1mA	0.2mA	2mA	0.05mA	0.5mA	
	Accuracy	±(0.1%set + 0.1%F.S. ¹)	±(0.1%set + 0.2%F.S.)	±(0.1%set + 0.2%F.S.)	±(0.1%set + 0.1%F.S. ¹)	±(0.1%set + 0.2%F.S.)	±(0.1%set + 0.1%F.S. ¹)	±(0.1%set + 0.2%F.S.)	±(0.1%set + 0.1%F.S. ¹)	±(0.1%set + 0.2%F.S.)	
CONSTANT POWER MODE + CONSTANT CURRENT MODE											
	Operating Range	1-10W	1-100W	1-30W	1-25W	1-250W	1-35W	1-350W	1-35W	1-350W	
	Setting Range	0-10.2W	0-102W	0-30.6W	0-25.5W	0-255W	0-35.7W	0-357W	0-35.7W	0-357W	
	Resolution	1mW	10mW	1mW	1mW	10mW	1mW	10mW	1mW	10mW	
	Accuracy	±(0.5%set + 0.5%F.S. ¹)	±(0.5%set + 0.5%F.S.)	±(0.5%set + 0.5%F.S.)	±(0.5%set + 0.5%F.S. ¹)		±(0.5%set + 0.5%F.S. ¹)	±(0.5%set + 0.5%F.S.)	±(0.5%set + 0.2%F.S. ¹)	±(0.5%set + 0.5%F.S.)	
	Current Setting Range	0-2.04A	0-20.4A	0-5.1A	0-4.08A	0-40.8A	0-7.14A	0-71.4A	0-1.02A	0-10.2A	
	Resolution	0.1mA	1mA	0.125mA	0.1mA	1mA	0.2mA	2mA	0.05mA	0.5mA	
	Accuracy	±(0.1%set + 0.1%F.S. ¹)	±(0.1%set + 0.2%F.S.)	±(0.1%set + 0.2%F.S.)	±(0.1%set + 0.1%F.S. ¹)	±(0.1%set + 0.2%F.S.)	±(0.1%set + 0.1%F.S. ¹)	±(0.1%set + 0.2%F.S.)	±(0.1%set + 0.1%F.S. ¹)	±(0.1%set + 0.2%F.S.)	
NOTE : ¹ : F.S. = Full scale of H Range											
DYNAMIC MODE											
	T1&T2	0.025ms - 10ms / Res : 1μs		0.025ms - 10ms / Res : 1μs			0.025ms - 10ms / Res : 1μs		0.025ms - 10ms / Res : 1μs		
		10ms - 30s / Res : 1ms		10ms - 30s / Res : 1ms			10ms - 30s / Res : 1ms		10ms - 30s / Res : 1ms		
	Accuracy	1μs / 1ms ± 100ppm		1μs / 1ms ± 100ppm			1μs / 1ms ± 100ppm		1μs / 1ms ± 100ppm		
CONSTANT CURRENT MODE											
	Slew Rate	0.32 - 80mA/μs	3.2 - 800mA/μs	0.8 - 200mA/μs	0.64 - 160mA/μs	6.4 - 1600mA/μs	0.001 - 0.28A/μs	0.01 - 2.8A/μs	0.16 - 40mA/μs	1.6 - 400mA/μs	
	Slew Rate Resolution	0.32mA/μs	3.2mA/μs	0.8mA/μs	0.64mA/μs	6.4mA/μs	0.001A/μs	0.01A/μs	0.16mA/μs	1.6mA/μs	
	Slew Rate Accuracy of Setting	±(10% + 15μs)		±(10% + 15μs)			±(10% + 15μs)		±(10% + 15μs)		
	Current Setting Range	0-2.04A	0-20.4A	0-5.1A	0-4.08A	0-40.8A	0-7.14A	0-71.4A	0-1.02A	0-10.2A	
	Current Resolution	0.1mA	1mA	0.125mA	0.1mA	1mA	0.2mA	2mA	0.05mA	0.5mA	
	Current Accuracy	±0.4% F.S.		±0.4% F.S.			±0.4% F.S.		±0.4% F.S.		
CONSTANT RESISTANCE MODE											
	Slew Rate	3.2 - 800mA/μs		0.8 - 200mA/μs			6.4 - 1600mA/μs		0.01 - 2.8A/μs		
	Slew Rate Resolution	3.2mA/μs		0.8mA/μs			6.4mA/μs		0.01A/μs		
	Slew Rate Accuracy of Setting	±(10% + 50μs)		±(10% + 50μs)			±(10% + 50μs)		±(10% + 50μs)		
	Resistance Setting Range	0.075Ω-300Ω(100W/16V) 3.75Ω-15kΩ(100W/80V)	0.3Ω-1.2kΩ(30W/16V) 15Ω-60kΩ(30W/80V)	0.0375Ω-150Ω(250W/16V) 1.875Ω-7.5kΩ(250W/80V)	0.025Ω-100Ω(350W/16V) 1.25Ω-5kΩ(350W/80V)	1.25Ω-5kΩ(350W/125V) 50Ω-200kΩ(350W/500V)					
	Resistance Resolution	0.333mS(100W/16V) 6.667μS(100W/80V)	83.333μS(30W/16V) 1.666μS(30W/80V)	0.666mS(250W/16V) 13.333μS(250W/80V)	1mS(350W/16V) 20μS(350W/80V)	20μS(350W/125V) 0.5μS(350W/500V)					
	Resistance Accuracy	3000 : ±(0.5%set + 0.1S) 15kΩ : ±(0.5%set + 0.01S)	1.2kΩ : ±(0.5%set + 0.1S) 60kΩ : ±(0.5%set + 0.01S)	1500 : ±(0.5%set + 0.1S) 7.5kΩ : ±(0.5%set + 0.01S)	1000 : ±(0.5%set + 0.1S) 5kΩ : ±(0.5%set + 0.01S)	5kΩ : ±(0.5%set + 0.02S) 200kΩ : ±(0.5%set + 0.005S)					
MEASUREMENT											
VOLTAGE READBACK											
	Range	0-16V	0-80V	0-16V	0-80V	0-16V	0-80V	0-16V	0-80V	0-125V	0-500V
	Resolution	0.32mV	1.6mV	0.32mV	1.6mV	0.32mV	1.6mV	0.32mV	1.6mV	2.5mV	10mV
	Accuracy	±(0.025%set + 0.025% F.S.)		±(0.025%set + 0.025% F.S.)			±(0.025%set + 0.025% F.S.)		±(0.025%set + 0.025% F.S.)		
CURRENT READBACK											
	Range	0-2A	0-20A	0-5A	0-4A	0-40A	0-7A	0-70A	0-1A	0-10A	
	Resolution	0.04mA	0.4mA	0.1mA	0.08mA	0.8mA	0.14mA	1.4mA	0.02mA	0.2mA	
	Accuracy	±(0.05%set + 0.05% F.S. ¹)		±(0.05%set + 0.05% F.S. ¹)			±(0.05%set + 0.05% F.S. ¹)		±(0.05%set + 0.05% F.S. ¹)		
POWER READBACK											
	Range	0-10W	0-100W	0-30W	0-25W	0-250W	0-35W	0-350W	0-35W	0-350W	
	Accuracy	±(0.1%set + 0.1% F.S. ¹)		±(0.1%set + 0.1% F.S. ¹)			±(0.1%set + 0.1% F.S. ¹)		±(0.1%set + 0.1% F.S. ¹)		
NOTE : ¹ : Power F.S. = Wrange F.S. x Irange F.S. ² : F.S. = Full scale of H Range											

Programmable D.C. Electronic Load



PEL-2000A(B) Series

PEL-2004A Rear Panel



PEL-2020A Rear Panel



PEL-2004B Rear Panel



PEL-2020B Rear Panel



SPECIFICATIONS

	PEL-2020A(B)	PEL-2030A(B)	PEL-2040A(B)	PEL-2041A(B)						
PROTECTIVE										
Over Power Protection										
Range	1~102W	0.9~30.6W	1.25~255W	1.75~357W						
Resolution	0.5W	0.15W	1.25W	1.75W						
Accuracy	±(2%set + 0.25%F.S)	±(2%set + 0.25%F.S)	±(2%set + 0.25%F.S)	±(2%set + 0.25%F.S)						
Over Current Protection										
Range	0.25~20.4A	0.0625~5.1A	0.5~40.8A	0.875~71.4A						
Resolution	0.05A	0.0125A	0.1A	0.175A						
Accuracy	±(2%set + 0.25%F.S)	±(2%set + 0.25%F.S)	±(2%set + 0.25%F.S)	±(2%set + 0.25%F.S)						
Over Voltage Protection										
Range	1~81.6V	1~81.6V	1~81.6V	1~81.6V						
Resolution	0.2V	0.2V	0.2V	0.2V						
Accuracy	±(2%set + 0.25%F.S)	±(2%set + 0.25%F.S)	±(2%set + 0.25%F.S)	±(2%set + 0.25%F.S)						
Over Temperature Protection	≈85°C	≈85°C	≈85°C	≈85°C						
Rated Power Protection										
Value	110W	33W	275W	385W						
Accuracy	±5%set	±5%set	±5%set	±5%set						
GENERAL										
SHORT CIRCUIT										
Current (CC)	≈2.2/2A	≈22/20A	≈5.5/5A	≈4.4/4A	≈44/40A	≈7.7/7A	≈77/70A	≈1.1/1A	≈11/10A	
Voltage (CV)	≈ 0V	≈ 0V	≈ 0V	≈ 0V	≈ 0V	≈ 0V	≈ 0V	≈ 0V	≈ 0V	
Resistance (CR)	≈3.75Ω	≈0.075Ω	≈15Ω	≈0.30	≈1.875Ω	≈0.0375Ω	≈1.25Ω	≈0.025Ω	≈50Ω	≈1.25Ω
INPUT RESISTANCE (LOAD OFF)	500kΩ (Typical)									
POWER SOURCE	100-120Vac/ 200-240Vac (90-132Vac/ 180-250Vac), 47 – 63Hz									
WEIGHT	Approx. 3.8kg									
DIMENSIONS & WEIGHT (PEL-2002A(B))	272(W) x 200(H) x 581(D) mm; Approx. 17.1kg (Full modules)									
DIMENSIONS & WEIGHT (PEL-2004A(B))	435(W) x 200(H) x 581(D) mm; Approx. 28.4kg (Full modules)									

ORDERING INFORMATION

- PEL-2020A(B) Dual Channel Module, (0~80V, 0~20A, 100W) x 2
- PEL-2030A(B) Dual Channel Module, (1~80V, 0~5A, 30W)+(1~80V, 0~40A, 250W)
- PEL-2040A(B) Single Channel Module, (0~80V, 0~70A, 350W)
- PEL-2041A(B) Single Channel Module, (0~500V, 0~10A, 350W)
- PEL-2004A(B) 4-Slot Programmable D.C. Electronic Load Mainframe
- PEL-2002A(B) 2-Slot Programmable D.C. Electronic Load Mainframe

Note : Load module cannot be used without a mainframe

ACCESSORIES :

- PEL-2002A(B)/2004A(B) User Manual x1, Power Cord x1
- PEL-2020A(B)/2030A(B)/2040A(B)/2041A(B) GTL-120 Test Lead x 1, GTL-121 Sense Lead x 1
- * PEL-003 x 3 (PEL-2004A(B)); PEL-003 x 1 (PEL-2002A(B))

OPTIONAL ACCESSORIES

PEL-001	GPIB Card	GTL-248	GPIB Cable (2m)
PEL-002	PEL-2000A(B) Series Rack Mount Kit	GTL-249	Frame Link Cable
PEL-003	Panel Cover	GTL-246	USB Cable, USB 2.0 A-B TYPE CABLE, 4P
PEL-016	LAN Card (for PEL-2000A(B) Main Frame)	GTL-232	RS-232C Cable, 9-pin, F-F Type, null modem, 2000mm

A. MODULARIZED STRUCTURE/PROGRAM & INTERFACE

Modularized Structure

PEL-2004A(B) is a 4-slot mainframe with a master control unit made to hold 4 load modules, and PEL-2002A(B) is a 2-slot mainframe with a master control unit made to hold 2 load modules. The modularized structure of the PEL-2000A(B) Series allows any combination of mainframe and load module (PEL-2020A(B), PEL-2030A(B), PEL-2040A(B), PEL-2041A(B)) to be integrated into a custom-tailored system.

Multiple loads within the same mainframe can be connected in parallel to perform both static and dynamic tests. This flexibility makes the PEL-2000A(B) Series a very cost-effective instrument for testing a broad range of power supply outputs.

Program & Interface

The PEL-2000A(B) Series supports a total of 12 different programs and 10 sequences to each program. With a total of up to 120 different configurations. For external control and system configuration, the PEL-Series has USB and RS-232 interfaces as standard and GPIB as an option. The LabView driver and Data Logging PC software are supported for all the interfaces available. Each channel has an analog control/monitoring connector to externally turn a load on/off and to externally monitor load input current and voltage.

B. AUTOMATICALLY SEQUENCE FUNCTION

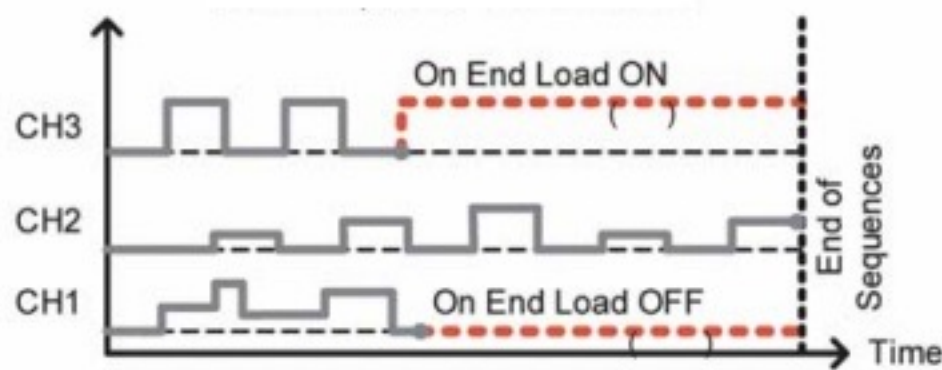

Sequence - On End Load

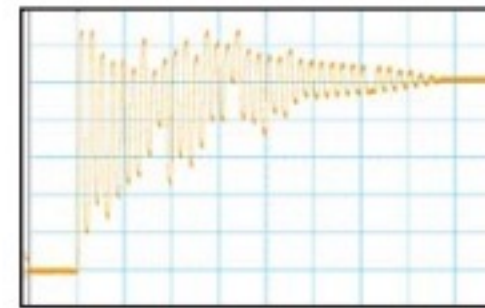

The figure above shows the current waveform of a simulation using the sequence function.

The Sequence function allows each channel to change its load sink according to a predefined sequence at a rate of up to $100\mu\text{s}$ per step. Each sequence is able to run concurrently, under the control of one clock. This is one of the most powerful features of the PEL-2000B Series as it is able to realistically simulate a multi-output power supply load. Under Dynamic mode, the load current or load resistance pulses between two preset levels at a pre-defined speed up to $25\mu\text{s}$ per step. This is often used as the standard test procedure to verify the response of a power supply to quick load changes.

The picture above is an example of a sequence used as a load profile for a single output switching power supply. A load profile is programmed to simulate the current drawn of a power supply load. By using a current probe to acquire a current waveform, PEL-2000A(B) Series is able to evaluate the performance of a power supply based on the load sequence that is programmed. An oscilloscope is then used to display the result.

C. PARALLEL DYNAMIC LOADING



Dynamic Test

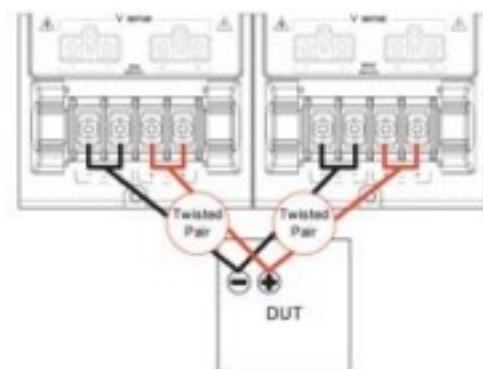

Wire Connection

All the load channels in a PEL-2000A(B) Series mainframe can be connected in parallel to perform any combination of static or dynamic loading. Under Dynamic mode, the load current or load resistance pulses between two preset levels at a predefined speed of up to $25\mu\text{s}$ per step. When the channels are connected in parallel, dynamic tests are synchronously clocked. The ability to perform parallel dynamic loading gives you the flexibility to perform dynamic tests to high-power power supplies without the need for a dedicated high power electronic load.

D. FRAME LINK

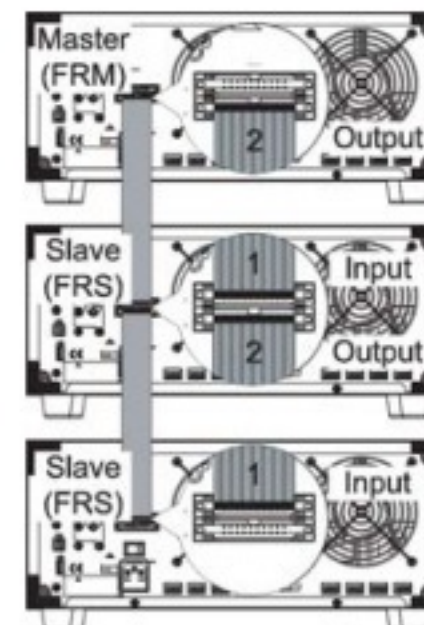

The PEL-2000A(B) Series allows multiple mainframes to be linked together with standard MIL 20-pin connectors to provide higher power load capacity. A maximum of 5 mainframes, including one master and 4 slaves, can be chained together to give a 7kW load capacity for high current and high power applications.

High Power DC Electronic Load



PEL-5000C Series

NEW



FEATURES

- * Maximum Power up to 192kW
- * Up to 8 units of Master/Slave Parallel Control
- * 5-digit Digital Voltage, Current and Power Meter
- * Large LCD Display
- * Display Voltage Value, Current Value, Watt Value at the Same Time
- * Suitable for Power Factor Regulator (PFC) Testing (600V, 1200V Models)
- * Automatically Perform OCP, OPP Test
- * The Power-on State Value Can be Set
- * Constant Current, Constant Resistance, Constant Voltage, Constant Power, Constant Current + Constant Voltage, Constant Power + Constant Voltage, Dynamic and Short Circuit Modes
- * Short Circuit Time Can be Set During Short Circuit Test
- * Over Current, Over Power, Over Temperature Protection and Over Voltage Warning
- * Voltage Polarity Display Can be Set to Positive Value ("+") or Negative Value ("-")
- * Support Solar Panel MPPT Test
- * Optional Interface: GPIB, RS232, USB, LAN

GW Instek PEL-5000C series single-channel electronic load provides 150V/ 600V/ 1200V models with a power range of 6kW~24kW. PEL-5000C has a total of 24 models featuring different combinations of power, voltage, and current. It can test and verify the specifications of batteries, electric vehicle chargers/charging stations, electric vehicle batteries and solar panels. PEL-5000C supports parallel connection for same voltage specification and different power models. PEL-5000C can support up to 8 units connected in parallel to provide a maximum power of 192kW.

For the scenario of battery testing, PEL-5000C specifically provides four battery discharge modes, namely CC+CV battery discharge test mode, CP+CV battery discharge test mode, CC+ UVP battery discharge test mode, and CP+ UVP battery discharge test mode. Users can choose a suitable test mode according to the test requirements. In addition to the four battery discharge modes, PEL-5000C also provides Time period discharge, Pulse discharge, and RAMP discharge modes. Users can set the discharge time, or discharge in the pulse current mode, or even set the rising/falling slew rate of the discharge current. These functions can be very flexible in the simulation of the battery discharge current waveform when an electric vehicle is running.

In order to meet the verification requirements of different DUTs, PEL-5000C provides a variety of test functions, including inrush current test mode, solar panel MPPT test mode, automated OCP, OPP test functions and 150 sets of parameter storage function. The 1200V model of PEL-5000C not only provides full power output at 1000V, but also provides 60% power output at 1200V output, which is higher than the 50% power output of other manufacturers of similar electronic loads. High-voltage batteries or chargers directly connected to the electronic load may cause damage to the electronic load. PEL-5000C has a built-in slow starter, which not only protects the DC load, but also saves the user's installation cost and setting time for measurement.

The communication interfaces supported by PEL-5000C include GPIB, RS232, USB, and LAN. The power, voltage and current of each model are shown in the following table:

ORDERING INFORMATION

PEL-5006C-150-600	150V/600A/6kW	High Power DC Electronic Load
PEL-5008C-150-800	150V/800A/8kW	High Power DC Electronic Load
PEL-5010C-150-1000	150V/1000A/10kW	High Power DC Electronic Load
PEL-5012C-150-1200	150V/1200A/12kW	High Power DC Electronic Load
PEL-5015C-150-1500	150V/1500A/15kW	High Power DC Electronic Load
PEL-5018C-150-1800	150V/1800A/18kW	High Power DC Electronic Load
PEL-5020C-150-2000	150V/2000A/20kW	High Power DC Electronic Load
PEL-5024C-150-2000	150V/2000A/24kW	High Power DC Electronic Load
PEL-5006C-600-420	600V/420A/6kW	High Power DC Electronic Load
PEL-5008C-600-560	600V/560A/8kW	High Power DC Electronic Load
PEL-5010C-600-700	600V/700A/10kW	High Power DC Electronic Load
PEL-5012C-600-840	600V/840A/12kW	High Power DC Electronic Load
PEL-5015C-600-1050	600V/1050A/15kW	High Power DC Electronic Load
PEL-5018C-600-1260	600V/1260A/18kW	High Power DC Electronic Load
PEL-5020C-600-1400	600V/1400A/20kW	High Power DC Electronic Load
PEL-5024C-600-1680	600V/1680A/24kW	High Power DC Electronic Load
PEL-5006C-1200-240	1200V/240A/6kW	High Power DC Electronic Load
PEL-5008C-1200-320	1200V/320A/8kW	High Power DC Electronic Load
PEL-5010C-1200-400	1200V/400A/10kW	High Power DC Electronic Load
PEL-5012C-1200-480	1200V/480A/12kW	High Power DC Electronic Load
PEL-5015C-1200-600	1200V/600A/15kW	High Power DC Electronic Load
PEL-5018C-1200-720	1200V/720A/18kW	High Power DC Electronic Load
PEL-5020C-1200-800	1200V/800A/20kW	High Power DC Electronic Load
PEL-5024C-1200-960	1200V/960A/24kW	High Power DC Electronic Load

PEL-5015C-1200-600

Power rating 15 → 15kW
Maximum output current: 600 → 600A
Maximum output voltage: 1200 → 1200V

STANDARD ACCESSORIES

PEL-5000C Series operation manual
BANANA PLUGS : Please refer to Fig.1 x 1
BNC – BNC CABLE : BNC to BNC CABLE, 1m x 1
HD-DSUB : 15PIN Parallel wire Parallel Wire x 1

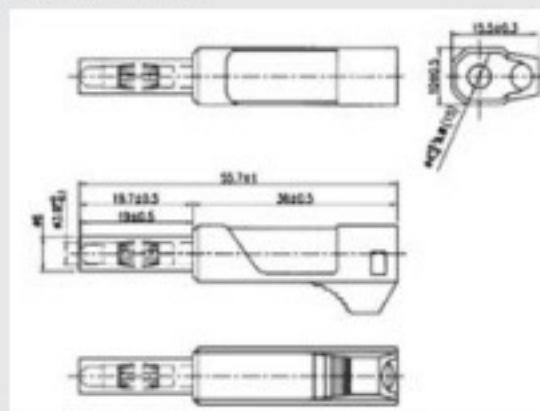

OPTIONAL ACCESSORIES

PEL-022	GPIB Card	PEL-030	GPIB+RS-232 Card
PEL-023	RS-232 Card	GTL-246	USB Cable, USB 2.0, A-B Type, 1200mm
PEL-024	LAN Card	GTL-248	GPIB Cable, Double Shielded, 2000mm
PEL-025	USB Card	GTL-250	GPIB Cable, Double Shielded, 600mm
PEL-026	Hook Ring x 4		
PEL-027-1	Rack Mount Kit For PEL-5006C		
PEL-027-2	Rack Mount Kit For PEL-5008C, PEL-5010C, PEL-5012C		
PEL-027-3	Rack Mount Kit For PEL-5015C, PEL-5018C		
PEL-027-4	Rack Mount Kit For PEL-5020C, PEL-5024C		
PEL-028	HANDLES, U-shaped Handle(fixed to the bracket)		

Rear Panel





PEL-5006C-150-600
PEL-5006C-600-420
PEL-5006C-1200-240



PEL-5008C-150-800
PEL-5008C-600-560
PEL-5008C-1200-320



PEL-5010C-150-1000
PEL-5010C-600-700
PEL-5010C-1200-400



PEL-5012C-150-1200
PEL-5012C-600-840
PEL-5012C-1200-480



PEL-5015C-150-1500
PEL-5015C-600-1050
PEL-5015C-1200-600



PEL-5018C-150-1800
PEL-5018C-600-1260
PEL-5018C-1200-720



PEL-5020C-150-2000
PEL-5020C-600-1400
PEL-5020C-1200-800



PEL-5024C-150-2000
PEL-5024C-600-1680
PEL-5024C-1200-960

Power / Voltage	150V	600V	1200V
6kW	PEL-5006C-150-600 (600A)	PEL-5006C-600-420 (420A)	PEL-5006C-1200-240 (240A)
8kW	PEL-5008C-150-800 (800A)	PEL-5008C-600-560 (560A)	PEL-5008C-1200-320 (320A)
10kW	PEL-5010C-150-1000 (1000A)	PEL-5010C-600-700 (700A)	PEL-5010C-1200-400 (400A)
12kW	PEL-5012C-150-1200 (1200A)	PEL-5012C-600-840 (840A)	PEL-5012C-1200-480 (480A)
15kW	PEL-5015C-150-1500 (1500A)	PEL-5015C-600-1050 (1050A)	PEL-5015C-1200-600 (600A)
18kW	PEL-5018C-150-1800 (1800A)	PEL-5018C-600-1260 (1260A)	PEL-5018C-1200-720 (720A)
20kW	PEL-5020C-150-2000 (2000A)	PEL-5020C-600-1400 (1400A)	PEL-5020C-1200-800 (800A)
24kW	PEL-5024C-150-2000 (2000A)	PEL-5024C-600-1680 (1680A)	PEL-5024C-1200-960 (960A)

PEL-022 GPIB Card



PEL-023 RS-232 Card



PEL-024 LAN Card



PEL-025 USB Card



PEL-026 Hook Ring



PEL-027-1-4 Rack Mount Kit



PEL-028 Handles



High Power DC Electronic Load

SPECIFICATIONS

MODEL	PEL-5006C-150-600		PEL-5008C-150-800		PEL-5010C-150-1000		PEL-5012C-150-1200	
Power ^{*1}	6kW		8kW		10kW		12kW	
Current	0 – 60A	0 – 600A	0 – 80A	0 – 800A	0 – 100A	0 – 1000A	0 – 120A	0 – 1200A
Voltage	0 – 150V							
Min. Operating Voltage	0.7V @ 600A		0.7V @ 800A		0.7V @ 1000A		0.7V @ 1200A	
Protections								
Over Power Protection (OPP)	105%							
Over Current Protection (OCP)	104%							
Over Voltage Protection (OVP)	105%							
Over Temp Protection (OTP)	90°C ± 5°C							
Constant Current Mode								
Range ^{*2}	60A	600A	80A	800A	100A	1000A	120A	1200A
Resolution	0.96mA	9.6mA	1.28mA	12.8mA	1.6mA	16mA	1.92mA	19.2mA
Accuracy ^{*3}	± 0.05% of (Setting + Range)							
Constant Resistance Mode								
Range	15000Ω–0.25Ω	0.25Ω–0.0012Ω	11250Ω–0.1875Ω	0.1875Ω–0.0009Ω	9000Ω–0.15Ω	0.15Ω–0.0007Ω	7500Ω–0.125Ω	0.125Ω–0.0006Ω
Resolution	66.666μS	4.167μΩ	88.888μS	3.125μΩ	111.111μS	2.5μΩ	133.333μS	2.084μΩ
Accuracy	± 0.2% of (Setting + Range)							
Constant Voltage Mode								
Range	150V							
Resolution	2.5mV							
Accuracy	± 0.05% of (Setting + Range)							
Constant Power Mode								
Range	600W	6000W	800W	8000W	1000W	10000W	1200W	12000W
Resolution	9.6mW	96mW	12.8mW	128mW	16mW	160mW	19.2mW	192mW
Accuracy	± 0.1% of (Setting+Range)	± 0.1% of (Setting+Range)	± 0.1% of (Setting+Range)	± 0.1% of (Setting+Range)	± 0.1% of (Setting+Range)	± 0.1% of (Setting+Range)	± 0.1% of (Setting+Range)	± 0.1% of (Setting+Range)
Constant Voltage Mode + Constant Current Mode								
Range	150V	600A	150V	800A	150V	1000A	150V	1200A
Resolution	2.5mV	9.6mA	2.5mV	12.8mA	2.5mV	3.2mA	2.5mV	19.2mA
Accuracy	± 1.0% of (Setting + Range)							
Constant Voltage Mode + Constant Power Mode								
Range	150V	6000W	150V	8000W	150V	10000W	150V	12000W
Resolution	2.5mV	96mW	2.5mV	128mW	2.5mV	160mW	2.5mV	192mW
Accuracy	± 1.0% of (Setting + Range)							
Surge Test								
Surge & Normal current	0~600A		0~800A		0~1000A		0~1200A	
Surge time	10~1000ms		10~1000ms		10~1000ms		10~1000ms	
Surge step	1~5							
MPPT Mode								
Algorithm	P&O							
Load mode	CV							
P&O interval	1000ms~60000ms ; resolution 1000ms							
Dynamic Mode								
Timing								
Thigh & Tlow	0.010~9.999 / 99.99 / 999.9 / 9999ms							
Resolution	0.001 / 0.01 / 0.1 / 1ms							
Accuracy	1μs / 10μs / 100μs / 1ms + 50ppm							
Slew Rate	0.0144A~0.9A/μs	0.144A~9A/μs	0.0192A~1.2A/μs	0.192A~12A/μs	0.024A~1.5A/μs	0.24A~15A/μs	0.0288A~1.8A/μs	0.288A~18A/μs
Resolution	0.0036A/μs	0.036A/μs	0.0048A/μs	0.048A/μs	0.006A/μs	0.06A/μs	0.0072A/μs	0.072A/μs
Min. Rise Time	66.7μs (typical)							
Current								
Range	0~60A	60~600A	0~80A	80~800A	0~100A	100~1000A	0~120A	120~1200A
Resolution	0.96mA	9.6mA	1.28mA	12.8mA	1.6mA	16mA	1.92mA	19.2mA
Measurement								
Voltage Read Back								
Range (5 Digital)	0~15V	15~150V	0~15V	15~150V	0~15V	15~150V	0~15V	15~150V
Resolution	0.25mV	2.5mV	0.25mV	2.5mV	0.25mV	2.5mV	0.25mV	2.5mV
Accuracy	± 0.025% of (Reading + Range)							
Current Read Back								
Range (5 Digital)	0~60A	60~600A	0~80A	80~800A	0~100A	100~1000A	0~120A	120~1200A
Resolution	0.96mA	9.6mA	1.28mA	12.8mA	1.6mA	16mA	1.92mA	19.2mA
Accuracy	± 0.05% of (Reading + Range)							
Power Read Back								
Range (5 Digital)	6000W		8000W		10000W		12000W	
Accuracy	± 0.06% of (Reading + Range)							
General								
Typical Short Resistance	0.0012Ω		0.0009Ω		0.0007Ω		0.0006Ω	
Maximum Short Current	600A		800A		1000A		1200A	
Load ON Voltage	0.25 – 62.5V							
Load OFF Voltage	0 – 62.5V							
Power Consumption	510VA		920VA		920VA		920VA	
Dimension (HxWxD)	445.6x481x757.3mm		571.6x481x757.3mm		571.6x481x757.3mm		571.6x481x757.3mm	
HxWxD (Not included Rack Mount Kit/heads)	341.6x445.2x757.3mm		467.6x445.2x757.3mm		467.6x445.2x757.3mm		467.6x445.2x757.3mm	
Weight	62 kg		77.5 kg		84.8 kg		92 kg	
Temperature ^{*4}	0~40°C							
Safety & EMC	CE							

Cooling : Advanced Fan Cooled

Input AC Power : 100~240 Vac ± 10% , 50/60Hz, Single-phase

Note *1 : The power rating specifications at ambient temperature = 25°C

Note *2 : The range is automatically or forcing to range II only in CC Mode

Note *3 : If the operating current is below range 0.1%, the accuracy specification is 0.1% F.S.

Note *4 : Operating temperature range is 0~40°C , all specifications apply for 25°C ± 5°C

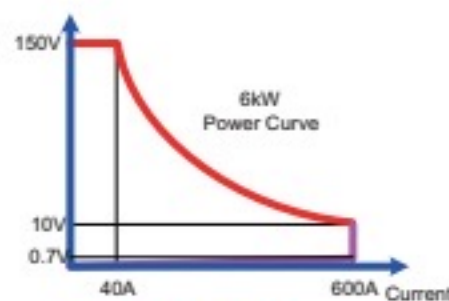

PEL-5006C-150-600

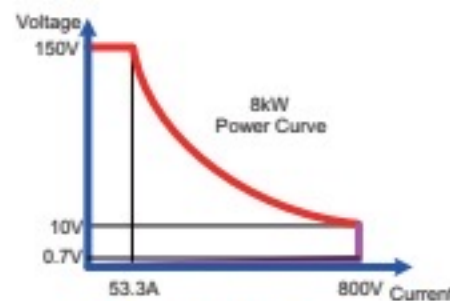

PEL-5008C-150-800

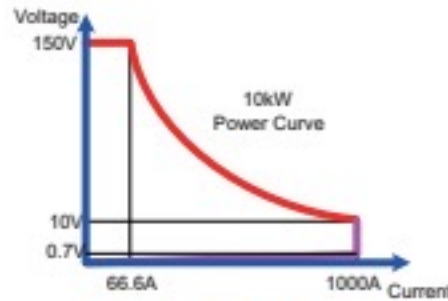

PEL-5010C-150-1000

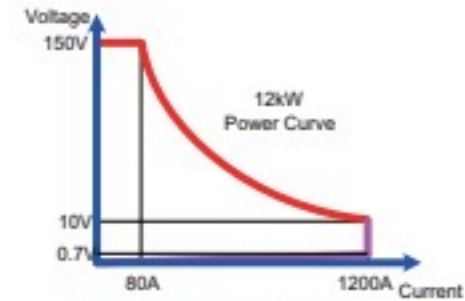

PEL-5012C-150-1200

SPECIFICATIONS

MODEL	PEL-5015C-150-1500		PEL-5018C-150-1800		PEL-5020C-150-2000		PEL-5024C-150-2000	
Power ^{*1}	15k W		18 kW		20 kW		24 kW	
Current	0 – 150A	0 – 1500A	0 – 180A	0 – 1800A	0 – 200A	0 – 2000A	0 – 200A	0 – 2000A
Voltage	0 – 150V							
Min. Operating Voltage	0.7V @ 1500A		0.7V @ 1800A		0.7V @ 2000A		0.7V @ 2000A	
Protections								
Over Power Protection (OPP)	105%							
Over Current Protection (OCP)	104%							
Over Voltage Protection (OVP)	105%							
Over Temp Protection (OTP)	90°C±5°C							
Constant Current Mode								
Range ^{*2}	150A	1500A	180A	1800A	200A	2000A	200A	2000A
Resolution	2.4mA	24mA	2.88mA	28.8mA	3.2mA	32mA	3.2mA	32mA
Accuracy ^{*3}	± 0.05% of (Setting + Range)							
Constant Resistance Mode								
Range	6000Ω~0.1Ω	0.1Ω~0.0005Ω	5000Ω~0.0833Ω	0.0833Ω~0.0004Ω	4500Ω~0.075Ω	0.075Ω~0.0004Ω	4500Ω~0.075Ω	0.075Ω~0.0004Ω
Resolution	166.666μS	1.667μΩ	200μS	1.389μΩ	222.22μS	1.25μΩ	222.22μS	1.25μΩ
Accuracy	±0.2% of (Setting + Range)							
Constant Voltage Mode								
Range	150V							
Resolution	2.5mV							
Accuracy	± 0.05% of (Setting + Range)							
Constant Power Mode								
Range	1500W	15000W	1800W	18000W	2000W	20000W	2400W	24000W
Resolution	24mW	240mW	28.8mW	288mW	32mW	320mW	38.4mW	384mW
Accuracy	± 0.1% of (Setting+Range)	± 0.1% of (Setting+Range)	± 0.1% of (Setting+Range)	± 0.1% of (Setting+Range)	± 0.1% of (Setting+Range)	± 0.1% of (Setting+Range)	± 0.1% of (Setting+Range)	± 0.1% of (Setting+Range)
Constant Voltage Mode + Constant Current Mode								
Range	150V	1500A	150V	1800A	150V	2000A	150V	2000A
Resolution	2.5mV	24mA	2.5mV	28.8mA	2.5mV	32mA	2.5mV	32mA
Accuracy	± 1.0% of (Setting + Range)							
Constant Voltage Mode + Constant Power Mode								
Range	150V	15000W	150V	18000W	150V	20000W	150V	24000W
Resolution	2.5mV	240mW	2.5mV	288mW	2.5mV	320mW	2.5mV	384mW
Accuracy	± 1.0% of (Setting + Range)							
Surge Test								
Surge & Normal current	0~1500A		0~1800A		0~2000A		0~2000A	
Surge time	10~1000ms		10~1000ms		10~1000ms		10~1000ms	
Surge step	1~5							
MPPT Mode								
Algorithm	P&O							
Load mode	CV							
P&O interval	1000ms~6000ms ; resolution 1000ms							
Dynamic Mode								
Timing								
Thigh & Tlow	0.010~9.999 / 99.99 / 999.9 / 9999ms							
Resolution	0.001 / 0.01 / 0.1 / 1ms							
Accuracy	1μs / 10μs / 100μs / 1ms + 50ppm							
Slew Rate	0.036A~2.25A/μs	0.360A~22.5A/μs	0.0432A~2.7A/μs	0.432A~27A/μs	0.048A~3A/μs	0.48A~30A/μs	0.048A~3A/μs	0.48A~30A/μs
Resolution	0.009A/μs	0.09A/μs	0.0108A/μs	0.108A/μs	0.012A/μs	0.12A/μs	0.012A/μs	0.12A/μs
Min. Rise Time	66.7μs(typical)							
Current								
Range	0~150A	150~1500A	0~180A	180~1800A	0~200A	200~2000A	0~200A	200~2000A
Resolution	2.4mA	24mA	2.88mA	28.8mA	3.2mA	32mA	3.2mA	32mA
Measurement								
Voltage Read Back								
Range (5 Digital)	0~15V	15~150V	0~15V	15~150V	0~15V	15~150V	0~15V	15~150V
Resolution	0.25mV	2.5mV	0.25mV	2.5mV	0.25mV	2.5mV	0.25mV	2.5mV
Accuracy	±0.025% of (Reading + Range)							
Current Read Back								
Range (5 Digital)	0~150A	15~1500A	0~180A	180~1800A	0~200A	200~2000A	0~200A	200~2000A
Resolution	2.4mA	24mA	2.88mA	28.8mA	3.2mA	32mA	3.2mA	32mA
Accuracy	± 0.05% of (Reading + Range)							
Power Read Back								
Range (5 Digital)	15000W		18000W		20000W		24000W	
Accuracy	± 0.06% of (Reading + Range)							
General								
Typical Short Resistance	0.0005Ω		0.0004Ω		0.0004Ω		0.0004Ω	
Maximum Short Current	1500A		1800A		2000A		2000A	
Load ON Voltage	0.25 ~ 62.5V							
Load OFF Voltage	0 ~ 62.5V							
Power Consumption	1320VA		1320VA		1700VA		1700VA	
Dimension (HxWxD)	760.6x481x757.3mm		760.6x481x757.3mm		886.6x481x757.3mm		886.6x481x757.3mm	
HxWxD(Not included Rack Mount Kit,wheels)	656.6x445.2x757.3mm		656.6x445.2x757.3mm		782.6x445.2x757.3mm		782.6x445.2x757.3mm	
Weight	116.5 kg		124 kg		140.5 kg		155 kg	
Temperature ^{*4}	0~40°C							
Safety & EMC	CE							

Cooling : Advanced Fan Cooled

Input AC Power : 100~240 Vac ±10% , 50/60Hz, Single-phase

Note *1 : The power rating specifications at ambient temperature = 25 °C

Note *2 : The range is automatically or forcing to range II only in CC Mode

Note *3 : If the operating current is below range 0.1%, the accuracy specification is 0.1% F.S.

Note *4 : Operating temperature range is 0~40 °C ; all specifications apply for 25 °C±5 °C

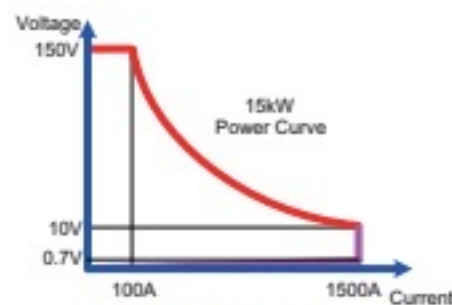

PEL-5015C-150-1500

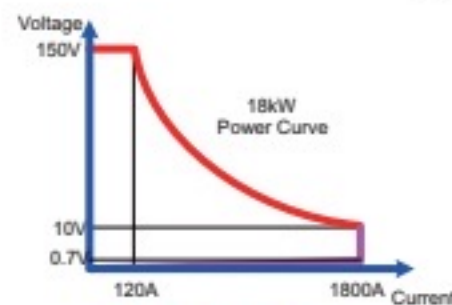

PEL-5018C-150-1800

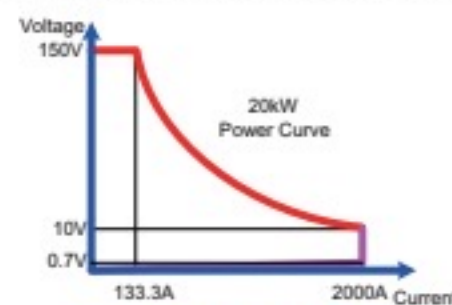

PEL-5020C-150-2000

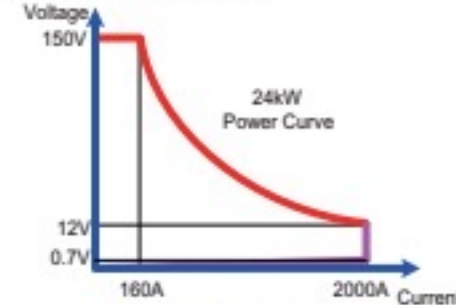

PEL-5024C-150-2000

High Power DC Electronic Load

SPECIFICATIONS

MODEL	PEL-5006C-600-420		PEL-5008C-600-560		PEL-5010C-600-700		PEL-5012C-600-840	
Power ^{*1}	6kW		8kW		10kW		12kW	
Current	0 - 42A	0 - 420A	0 - 56A	0 - 560A	0 - 70A	0 - 700A	0 - 84A	0 - 840A
Voltage	0 - 600V							
Min. Operating Voltage	10V @ 420A		10V @ 560A		10V @ 700A		10V @ 840A	
Protections								
Over Power Protection (OPP)	105%							
Over Current Protection (OCP)	104%							
Over Voltage Protection (OVP)	105%							
Over Temp Protection (OTP)	90°C ± 5°C							
Constant Current Mode								
Range ^{*2}	42A	420A	56A	560A	70A	700A	84A	840A
Resolution	0.672mA	6.72mA	0.896mA	8.96mA	1.12mA	11.2mA	1.334mA	13.44mA
Accuracy ^{*3}	± 0.05% of (Setting + Range)							
Constant Resistance Mode								
Range	85712Ω-1.42853Ω	1.42853Ω-0.02384Ω	64284Ω-1.0714Ω	1.0714Ω-0.01788Ω	51427.2Ω-0.85712Ω	0.85712Ω-0.014304Ω	42856Ω-0.714267Ω	0.714267Ω-0.01192Ω
Resolution	11.6669μS	23.84μΩ	15.5559μS	17.88μΩ	19.4449μS	14.304μΩ	23.3339μS	11.92μΩ
Accuracy	± 0.2% of (Setting + Range)							
Constant Voltage Mode								
Range	600V							
Resolution	10mV							
Accuracy	± 0.05% of (Setting + Range)							
Constant Power Mode								
Range	600W	6000W	800W	8000W	1000W	10000W	1200W	12000W
Resolution	9.6mW	96mW	12.8mW	128mW	16mW	160mW	19.2mW	192mW
Accuracy	± 0.2% of (Setting+Range)	± 0.1% of (Setting+Range)	± 0.2% of (Setting+Range)	± 0.1% of (Setting+Range)	± 0.2% of (Setting+Range)	± 0.1% of (Setting+Range)	± 0.2% of (Setting+Range)	± 0.1% of (Setting+Range)
Constant Voltage Mode + Constant Current Mode								
Range	600V	420A	600V	560A	600V	700A	600V	840A
Resolution	10mV	6.72mA	10mV	8.96mA	10mV	11.2mA	10mV	13.44mA
Accuracy	± 1.0% of (Setting + Range)							
Constant Voltage Mode + Constant Power Mode								
Range	600V	6000W	600V	8000W	600V	10000W	600V	12000W
Resolution	10mV	96mW	10mV	128mW	10mV	160mW	10mV	192mW
Accuracy	± 1.0% of (Setting + Range)							
Surge Test								
Surge & Normal current	0-420A		0-560A		0-700A		0-840A	
Surge time	10-1000ms		10-1000ms		10-1000ms		10-1000ms	
Surge step	1-5							
MPPT Mode								
Algorithm	P&O							
Load mode	CV							
P&O interval	1000ms-6000ms ; resolution 1000ms							
Dynamic Mode								
Timing								
Thigh & Tlow	0.010-9.999 / 99.99 / 999.9 / 9999ms							
Resolution	0.001 / 0.01 / 0.1 / 1ms							
Accuracy	1μs / 10μs / 100μs / 1ms + 50ppm							
Slew Rate	0.0288-1.8A/μs	0.288A-18A/μs	0.0288A-1.8A/μs	0.288A-18A/μs	0.0336A-2.1A/μs	0.336A-21A/μs	0.0384A-2.4/μs	0.384A-24A/μs
Resolution	0.0072A/μs	0.072A/μs	0.0072A/μs	0.072A/μs	0.0084A/μs	0.084A/μs	0.0096A/μs	0.096A/μs
Current								
Range	0-42A	42-420A	0-56A	56-560A	0-70A	70-700A	0-84A	84-840A
Resolution	0.672mA	6.72mA	0.896mA	8.96mA	1.12mA	11.2mA	1.334mA	13.34mA
Measurement								
Voltage Read Back								
Range (5 Digital)	0-60V	60-600V	0-60V	60-600V	0-60V	60-600V	0-60V	60-600V
Resolution	1mV	10mV	1mV	10mV	1mV	10mV	1mV	10mV
Accuracy	± 0.025% of (Reading + Range)							
Current Read Back								
Range (5 Digital)	0-42A	42-420A	0-56A	56-560A	0-70A	70-700A	0-84A	84-840A
Resolution	0.672mA	6.72mA	0.896mA	8.96mA	1.12mA	11.2mA	1.334mA	13.34mA
Accuracy	± 0.05% of (Reading + Range)							
Power Read Back								
Range (5 Digital)	6000W		8000W		10000W		12000W	
Accuracy	± 0.06% of (Reading + Range)							
General								
Typical Short Resistance	0.0239Ω		0.0179Ω		0.0143Ω		0.00120Ω	
Maximum Short Current	420A		560A		700A		840A	
Load ON Voltage	0.4 - 100V							
Load OFF Voltage	0 - 100V							
Power Consumption	510VA		920VA		920VA		920VA	
Dimension (HxWxD)	445.6x481x757.3mm		571.6x481x757.3mm		571.6x481x757.3mm		571.6x481x757.3mm	
HxWxD (Not included Rack Mount Kit/wheel)	341.6x445.2x757.3mm		467.6x445.2x757.3mm		467.6x445.2x757.3mm		467.6x445.2x757.3mm	
Weight	62 kg		77.5 kg		84.8 kg		92 kg	
Temperature ^{*4}	0-40°C							
Safety & EMC	CE							

Cooling : Advanced Fan Cooled

Input AC Power : 100-240 Vac ±10% , 50/60Hz, Single-phase

Note *1 : The power rating specifications at ambient temperature = 25 °C

Note *2 : The range is automatically or forcing to range II only in CC Mode

Note *3 : If the operating current is below range 0.1%, the accuracy specification is 0.1% F.S.

Note *4 : Operating temperature range is 0-40 °C , all specifications apply for 25 °C ± 5 °C

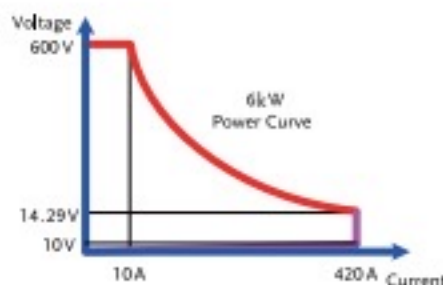

PEL-5006C-600-420

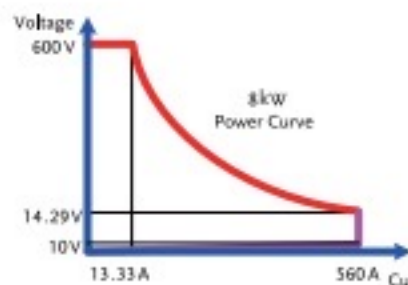

PEL-5008C-600-560

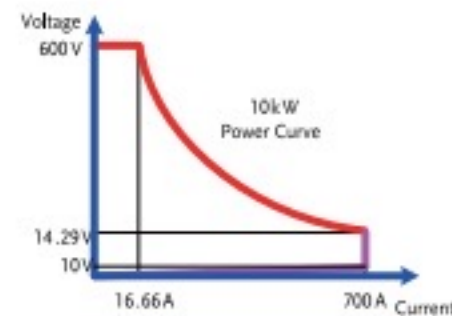

PEL-5010C-600-700

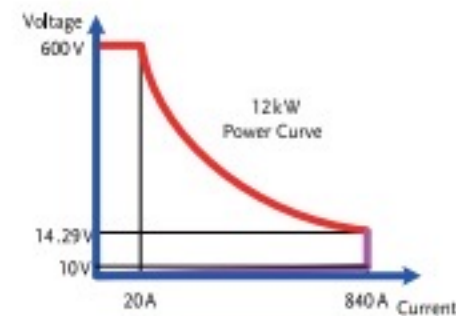

PEL-5012C-600-840

SPECIFICATIONS

MODEL	PEL-5015C-600-1050		PEL-5018C-600-1260		PEL-5020C-600-1400		PEL-5024C-600-1680	
Power ^{*1}	15 kW		18 kW		20 kW		24 kW	
Current	0 – 105A	0 – 1050A	0 – 126A	0 – 1260A	0 – 140A	0 – 1400A	0 – 168A	0 – 1680A
Voltage	0 – 600V							
Min. Operating Voltage	10V @ 1050A		10V @ 1260A		10V @ 1400A		10V @ 1680A	
Protections								
Over Power Protection (OPP)	105%							
Over Current Protection (OCP)	104%							
Over Voltage Protection (OVP)	105%							
Over Temp Protection (OTP)	90°C ± 5°C							
Constant Current Mode								
Range ^{*2}	105A	1050A	126A	1260A	140A	1400A	168A	1680A
Resolution	1.68mA	16.8mA	2.016mA	20.16mA	2.24mA	22.4mA	2.688mA	26.88mA
Accuracy ^{*3}	± 0.05% of (Setting + Range)							
Constant Resistance Mode								
Range	34284.8–0.571413Ω	0.571413–0.009536Ω	28570.67–0.476178Ω	0.476178–0.007947Ω	25713.6–0.42856Ω	0.42856–0.007152Ω	21428–0.357133Ω	0.357133–0.00596Ω
Resolution	29.1674μS	9.536μΩ	35.0009μS	7.947μΩ	38.8899μS	7.152μΩ	46.6679μS	5.96μΩ
Accuracy	± 0.2% of (Setting + Range)							
Constant Voltage Mode								
Range	600V							
Resolution	10mV							
Accuracy	± 0.05% of (Setting + Range)							
Constant Power Mode								
Range	1500W	15000W	1800W	18000W	2000W	20000W	2400W	24000W
Resolution	24mW	240mW	28.8mW	288mW	32mW	320mW	38.4mW	384mW
Accuracy	± 0.2% of (Setting+Range)	± 0.1% of (Setting+Range)	± 0.2% of (Setting+Range)	± 0.1% of (Setting+Range)	± 0.2% of (Setting+Range)	± 0.1% of (Setting+Range)	± 0.2% of (Setting+Range)	± 0.1% of (Setting+Range)
Constant Voltage Mode + Constant Current Mode								
Range	600V	1050A	600V	1260A	600V	1400A	600V	1680A
Resolution	10mV	16.8mA	10mV	20.16mA	10mV	22.4mA	10mV	26.88mA
Accuracy	± 1.0% of (Setting + Range)							
Constant Voltage Mode + Constant Power Mode								
Range	600V	15000W	600V	18000W	600V	20000W	600V	24000W
Resolution	10mV	240mW	10mV	288mW	10mV	320mW	10mV	384mW
Accuracy	± 1.0% of (Setting + Range)							
Surge Test								
Surge & Normal current	0~1050A		0~1260A		0~1400A		0~1680A	
Surge time	10~1000ms		10~1000ms		10~1000ms		10~1000ms	
Surge step	1~5							
MPPT Mode								
Algorithm	P&O							
Load mode	CV							
P&O interval	1000ms~60000ms ; resolution 1000ms							
Dynamic Mode								
Timing								
Thigh & Tlow	0.010–9.999 / 99.99 / 999.9 / 9999ms							
Resolution	0.001 / 0.01 / 0.1 / 1ms							
Accuracy	1μs / 10μs / 100μs / 1ms + 50ppm							
Slew Rate	0.0432A–2.7A/μs	0.432A–27A/μs	0.048A–3A/μs	0.48A–30A/μs	0.0528A–3.3A/μs	0.528A–33A/μs	0.0576A–3.6A/μs	0.576A–36A/μs
Resolution	0.0108A/μs	0.108A/μs	0.012A/μs	0.12A/μs	0.0132A/μs	0.132A/μs	0.0144A/μs	0.144A/μs
Current								
Range	0~105A	105~1050A	0~126A	126~1260A	0~140A	140~1400A	0~168A	168~1680A
Resolution	1.68mA	16.8mA	2.016mA	20.16mA	2.24mA	22.4mA	2.688mA	26.88mA
Measurement								
Voltage Read Back								
Range (5 Digital)	0–60V	60–600V	0–60V	60–600V	0–60V	60–600V	0–60V	60–600V
Resolution	1mV	10mV	1mV	10mV	1mV	10mV	1mV	10mV
Accuracy	± 0.025% of (Reading + Range)							
Current Read Back								
Range (5 Digital)	0~105A	105~1050A	0~126A	126~1260A	0~140A	140~1400A	0~168A	168~1680A
Resolution	1.68mA	16.8mA	2.016mA	20.16mA	2.24mA	22.4mA	2.688mA	26.88mA
Accuracy	± 0.05% of (Reading + Range)							
Power Read Back								
Range (5 Digital)	15000W		18000W		20000W		24000W	
Accuracy	± 0.06% of (Reading + Range)							
General								
Typical Short Resistance	0.0096Ω		0.0080Ω		0.0072Ω		0.0060Ω	
Maximum Short Current	1050A		1260A		1400A		1680A	
Load ON Voltage	0.4 ~ 100V							
Load OFF Voltage	0 – 100V							
Power Consumption	1320VA		1320VA		1700VA		1700VA	
Dimension (HxWxD)	760.6x481x757.3mm		760.6x481x757.3mm		886.6x481x757.3mm		886.6x481x757.3mm	
HxWxD ^(Not Included Rack Mount Kit/Reds)	656.6x445.2x757.3mm		656.6x445.2x757.3mm		782.6x445.2x757.3mm		782.6x445.2x757.3mm	
Weight	116.5 kg		124 kg		140.5 kg		155 kg	
Temperature ^{*4}	0–40°C							
Safety & EMC	CE							

Cooling : Advanced Fan Cooled

Input AC Power : 100~240 Vac ±10% * 50/60Hz, Single-phase

Note *1 : The power rating specifications at ambient temperature = 25 °C

Note *2 : The range is automatically or forcing to range II only in CC Mode

Note *3 : If the operating current is below range 0.1%, the accuracy specification is 0.1% F.S.

Note *4 : Operating temperature range is 0~40 °C * all specifications apply for 25 °C ± 5 °C

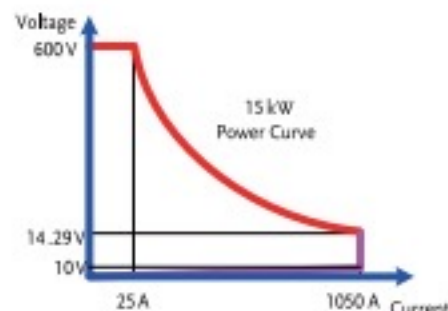

PEL-5015C-600-1050

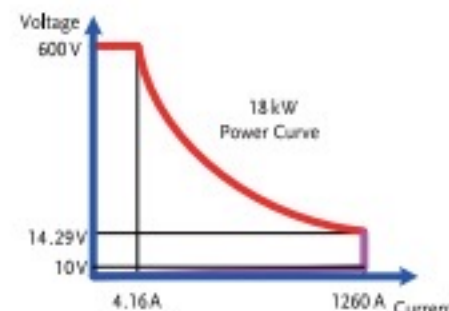

PEL-5018C-600-1260

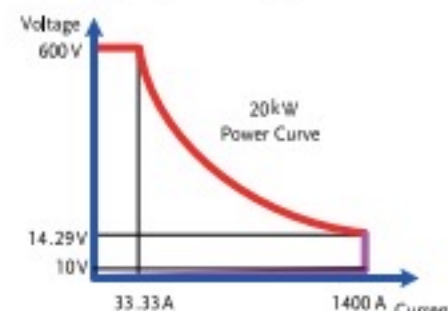

PEL-5020C-600-1400

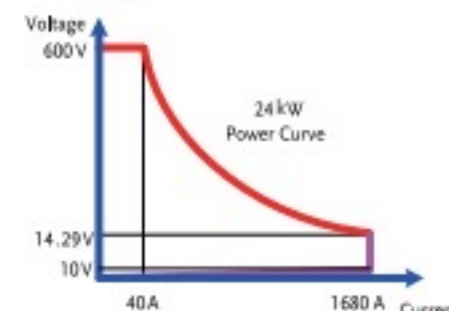

PEL-5024C-600-1680

High Power DC Electronic Load

SPECIFICATIONS

MODEL	PEL-5006C-1200-240		PEL-5008C-1200-320		PEL-5010C-1200-400		PEL-5012C-1200-480	
Power ^{*1}	6 kW		8 kW		10 kW		12 kW	
Current	0 ~ 24A	0 ~ 240A	0 ~ 32A	0 ~ 320A	0 ~ 40A	0 ~ 400A	0 ~ 48A	0 ~ 480A
Voltage	0 ~ 1200V							
Min. Operating Voltage	15V @ 240A		15V @ 320A		15V @ 400A		15V @ 480A	
Protections								
Over Power Protection (OPP)	105%							
Over Current Protection (OCP)	104%							
Over Voltage Protection (OVP)	104%							
Over Temp Protection (OTP)	90°C ± 5°C							
Constant Current Mode								
Range ^{*2}	24A	240A	32A	320A	40A	400A	48A	480A
Resolution	0.384mA	3.84mA	0.512mA	5.12mA	0.64mA	6.4mA	0.768mA	7.68mA
Accuracy ^{*3}	± 0.05% of (Setting + Range)							
Constant Resistance Mode								
Range	30KΩ-5Ω	5Ω-0.0625Ω	22.5KΩ-3.75Ω	3.75Ω-0.0468Ω	18KΩ-3Ω	3Ω-0.0375Ω	15KΩ-2.5Ω	2.5Ω-0.0312Ω
Resolution	3.333μS	83.334μΩ	4.444μS	62.5μΩ	5.555μS	50μΩ	6.666μS	41.667μΩ
Accuracy	± 0.2% of (Setting + Range)							
Constant Voltage Mode								
Range	1200V							
Resolution	20mV							
Accuracy	± 0.05% of (Setting + Range)							
Constant Power Mode								
Range	600W	6000W	800W	8000W	1000W	10000W	1200W	12000W
Resolution	9.6mW	96mW	12.8mW	128mW	16mW	160mW	19.2mW	192mW
Accuracy	± 0.1% of (Setting+Range)	± 0.1% of (Setting+Range)	± 0.1% of (Setting+Range)	± 0.1% of (Setting+Range)	± 0.1% of (Setting+Range)	± 0.1% of (Setting+Range)	± 0.1% of (Setting+Range)	± 0.1% of (Setting+Range)
Constant Voltage Mode + Constant Current Mode								
Range	1200V	240A	1200V	320A	1200V	400A	1200V	480A
Resolution	20mV	3.84mA	20mV	5.12mA	20mV	6.4mA	20mV	7.68mA
Accuracy	± 1.0% of (Setting + Range)							
Constant Voltage Mode + Constant Power Mode								
Range	1200V	6000W	1200V	8000W	1200V	10000W	1200V	12000W
Resolution	20mV	96mW	20mV	128mW	20mV	160mW	20mV	192mW
Accuracy	± 1.0% of (Setting + Range)							
Surge Test								
Surge & Normal current	0~240A		0~320A		0~400A		0~480A	
Surge time	10~1000ms		10~1000ms		10~1000ms		10~1000ms	
Surge step	1~5							
MPPT Mode								
Algorithm	P&O							
Load mode	CV							
P&O interval	1000ms~60000ms ; resolution 1000ms							
Dynamic Mode								
Timing								
Thigh & Tlow	0.010~9.999 / 99.99 / 999.9 / 9999ms							
Resolution	0.001 / 0.01 / 0.1 / 1ms							
Accuracy	1μs / 10μs / 100μs / 1ms + 50ppm							
Slew Rate	0.0192A~1.2A/μs	0.192A~12A/μs	0.0192A~1.2A/μs	0.192A~12A/μs	0.0224A~1.4A/μs	0.224A~14A/μs	0.0256A~1.6A/μs	0.256A~16A/μs
Resolution	0.0048A/μs	0.048A/μs	0.0048A/μs	0.048A/μs	0.0056A/μs	0.056A/μs	0.0064A/μs	0.064A/μs
Current								
Range	0~24A	24~240A	0~32A	32~320A	0~40A	40~400A	0~48A	48~480A
Resolution	0.384mA	3.84mA	0.512mA	5.12mA	0.64mA	6.4mA	0.768mA	7.68mA
Measurement								
Voltage Read Back								
Range (5 Digital)	0~120V	120~1200V	0~120V	120~1200V	0~120V	120~1200V	0~120V	120~1200V
Resolution	2mV	20mV	2mV	20mV	2mV	20mV	2mV	20mV
Accuracy	± 0.025% of (Reading + Range)							
Current Read Back								
Range (5 Digital)	0~24A	24~240A	0~32A	32~320A	0~40A	40~400A	0~48A	48~480A
Resolution	0.384mA	3.84mA	0.512mA	5.12mA	0.64mA	6.4mA	0.768mA	7.68mA
Accuracy	± 0.05% of (Reading + Range)							
Power Read Back								
Range (5 Digital)	6000W		8000W		10000W		12000W	
Accuracy	± 0.06% of (Reading + Range)							
General								
Typical Short Resistance	0.0625Ω		0.0469Ω		0.0375Ω		0.0313Ω	
Maximum Short Current	240A		320A		400A		480A	
Load ON Voltage	0.96 ~ 240V							
Load OFF Voltage	0 ~ 240V							
Power Consumption	510VA		920VA		920VA		920VA	
Dimension (HxWxD)	445.6x481x757.3mm		571.6x481x757.3mm		571.6x481x757.3mm		571.6x481x757.3mm	
HxWxD(Not included Rack Mount Kit/wheel)	341.6x445.2x757.3mm		467.6x445.2x757.3mm		467.6x445.2x757.3mm		467.6x445.2x757.3mm	
Weight	62 kg		77.5 kg		84.8 kg		92 kg	
Temperature ^{*4}	0~40°C							
Safety & EMC	CE							

Cooling : Advanced Fan Cooled

Input AC Power : 100~240 Vac ±10% , 50/60Hz, Single-phase

Note *1 : The power rating specifications at ambient temperature = 25 °C

Note *2 : The range is automatically or forcing to range II only in CC Mode

Note *3 : If the operating current is below range 0.1%, the accuracy specification is 0.1% F.S.

Note *4 : Operating temperature range is 0~40 °C , all specifications apply for 25 °C ± 5 °C

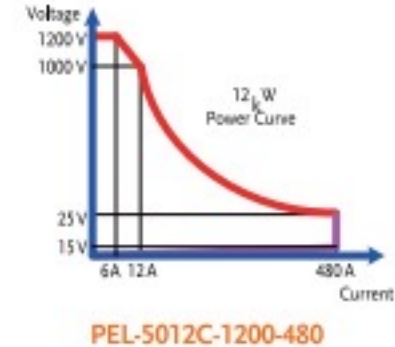
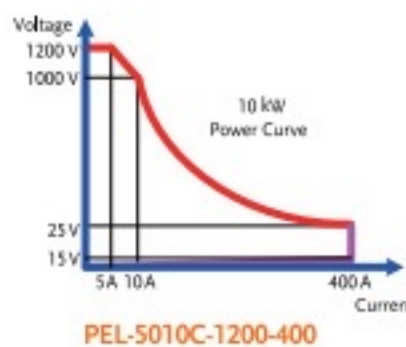
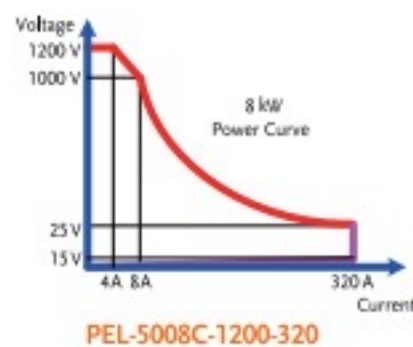
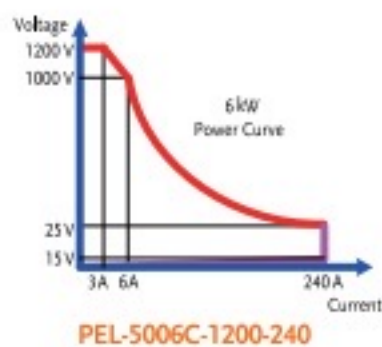

SPECIFICATIONS

MODEL	PEL-5015C-1200-600		PEL-5018C-1200-720		PEL-5020C-1200-800		PEL-5024C-1200-960	
Power ^{*1}	15kW		18kW		20kW		24kW	
Current	0 – 60A	0 – 600A	0 – 72A	0 – 720A	0 – 80A	0 – 800A	0 – 96A	0 – 960A
Voltage	0 – 1200V							
Min. Operating Voltage	15V @ 600A		15V @ 720A		15V @ 800A		15V @ 960A	
Protections								
Over Power Protection (OPP)	105%							
Over Current Protection (OCP)	104%							
Over Voltage Protection (OVP)	104%							
Over Temp Protection (OTP)	90°C±5°C							
Constant Current Mode								
Range ^{*2}	60A	600A	72A	720A	80A	800A	96A	960A
Resolution	0.96mA	9.6mA	1.152mA	11.52mA	1.28mA	12.8mA	1.536mA	15.36mA
Accuracy ^{*3}	± 0.05% of (Setting + Range)							
Constant Resistance Mode								
Range	12Ω~2Ω	2Ω~0.0250Ω	10KΩ~1.666Ω	1.666Ω~0.0208Ω	9KΩ~1.5Ω	1.5Ω~0.0187Ω	7.5KΩ~1.25Ω	1.25Ω~0.0156Ω
Resolution	8.3333μS	33.334μΩ	10μS	27.778μΩ	11.111μS	25μΩ	13.333μS	20.834μΩ
Accuracy	±0.2% of (Setting + Range)							
Constant Voltage Mode								
Range	1200V							
Resolution	20mV							
Accuracy	± 0.05% of (Setting + Range)							
Constant Power Mode								
Range	1500W	15000W	1800W	18000W	2000W	20000W	2400W	24000W
Resolution	24mW	240mW	28.8mW	288mW	32mW	320mW	38.4mW	384mW
Accuracy	± 0.1% of (Setting+Range)	± 0.1% of (Setting+Range)	± 0.1% of (Setting+Range)	± 0.1% of (Setting+Range)	± 0.1% of (Setting+Range)	± 0.1% of (Setting+Range)	± 0.1% of (Setting+Range)	± 0.1% of (Setting+Range)
Constant Voltage Mode + Constant Current Mode								
Range	1200V	600A	1200V	720A	1200V	800A	1200V	960A
Resolution	20mV	9.6mA	20mV	3.2mA	20mV	3.84mA	20mV	15.36mA
Accuracy	± 1.0% of (Setting + Range)							
Constant Voltage Mode + Constant Power Mode								
Range	1200V	15000W	1200V	18000W	1200V	20000W	1200V	24000W
Resolution	20mV	240mW	20mV	288mW	20mV	320mW	20mV	384mW
Accuracy	± 1.0% of (Setting + Range)							
Surge Test								
Surge & Normal current	0~600A		0~720A		0~800A		0~960A	
Surge time	10~1000ms		10~1000ms		10~1000ms		10~1000ms	
Surge step	1~5							
MPPT Mode								
Algorithm	P&O							
Load mode	CV							
P&O interval	1000ms~60000ms ; resolution 1000ms							
Dynamic Mode								
Timing	0.010~9.999 / 99.99 / 999.9 / 9999ms							
Thigh & Tlow	0.001 / 0.01 / 0.1 / 1ms							
Resolution	1μs / 10μs / 100μs / 1ms + 50ppm							
Accuracy	0.0288A~1.8A/μs 0.288A~18A/μs 0.032A~2A/μs 0.32A~20A/μs 0.0352A~2.2A/μs 0.352A~22A/μs 0.0384A~2.4A/μs 0.384A~24A/μs							
Slew Rate	0.0072A/μs 0.072A/μs 0.008A/μs 0.08A/μs 0.0088A/μs 0.088A/μs 0.0096A/μs 0.096A/μs							
Resolution	0.0072A/μs 0.072A/μs 0.008A/μs 0.08A/μs 0.0088A/μs 0.088A/μs 0.0096A/μs 0.096A/μs							
Current								
Range	0~60A	60~600A	0~72A	72~720A	0~80A	80~800A	0~96A	96~960A
Resolution	0.96mA	9.6mA	1.152mA	11.52mA	1.28mA	12.8mA	1.536mA	15.36mA
Measurement								
Voltage Read Back								
Range (5 Digital)	0~120V	120~1200V	0~120V	120~1200V	0~120V	120~1200V	0~120V	120~1200V
Resolution	2mV	20mV	2mV	20mV	2mV	20mV	2mV	20mV
Accuracy	±0.025% of (Reading + Range)							
Current Read Back								
Range (5 Digital)	0~60A	60~600A	0~72A	72~720A	0~80A	80~800A	0~96A	96~960A
Resolution	0.96mA	9.6mA	1.152mA	11.52mA	1.28mA	12.8mA	1.536mA	15.36mA
Accuracy	±0.05% of (Reading + Range)							
Power Read Back								
Range (5 Digital)	15000W		18000W		20000W		24000W	
Accuracy	± 0.06% of (Reading + Range)							
General								
Typical Short Resistance	0.0250Ω		0.0209Ω		0.0188Ω		0.0157Ω	
Maximum Short Current	600A		720A		800A		960A	
Load ON Voltage	0.96 ~ 240V							
Load OFF Voltage	0 ~ 240V							
Power Consumption	1320VA		1320VA		1700VA		1700VA	
Dimension (HxWxD)	760.6x481x757.3mm		760.6x481x757.3mm		886.6x481x757.3mm		886.6x481x757.3mm	
HxWxD (Not included Rack Mount Kit/height)	656.6x445.2x757.3mm		656.6x445.2x757.3mm		782.6x445.2x757.3mm		782.6x445.2x757.3mm	
Weight	116.5 kg		124 kg		140.5 kg		155 kg	
Temperature ^{*4}	0~40°C							
Safety & EMC	CE							

Cooling : Advanced Fan Cooled

Input AC Power : 100~240 Vac ±10% , 50/60Hz, Single-phase

Note *1 : The power rating specifications at ambient temperature = 25°C

Note *2 : The range is automatically or forcing to range II only in CC Mode

Note *3 : If the operating current is below range 0.1%, the accuracy specification is 0.1% F.S.

Note *4 : Operating temperature range is 0~40°C , all specifications apply for 25°C±5°C

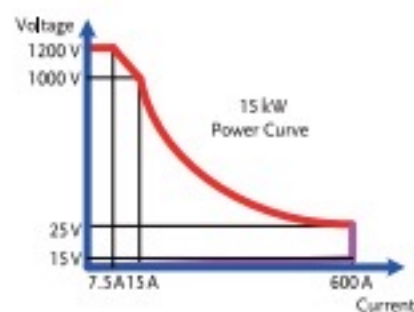

PEL-5015C-1200-600

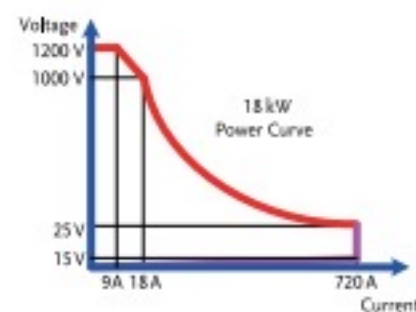

PEL-5018C-1200-720

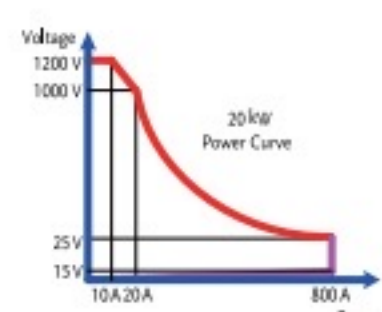

PEL-5020C-1200-800

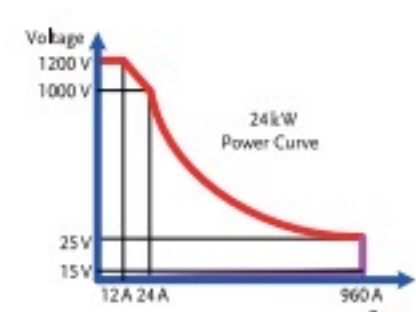

PEL-5024C-1200-960

DC Electronic Load



PEL-503-80-50

NEW



PEL-507-80-140

NEW



FEATURES

- * 5-digit Digital Voltage, Current and Power Meter
- * Simultaneous Display of Voltage, Current, and Watts
- * Short-circuit Time Can be Set During Short-circuit Test
- * Automatic Test Function of Overcurrent Protection/Overpower Protection
- * The Battery Discharge Test Function Can Set the Discharge Stop Voltage(V_{batt}), Discharge Capacity(AH, WH) and Stop Discharge Time
- * Surge Test Can Simulate Boot Overshoot Current and Transient Current From Hot Plugging
- * Constant Current, Constant Resistance, Constant Voltage, Constant Power and Dynamic Mode
- * Overvoltage, Overcurrent, Overpower, Over Temperature Protection and Reverse Polarity Detection
- * Voltage Polarity Display Can be set to Positive Value "+" or Negative Value "-"
- * Communications Interface: RS232, USB

The PEL-500 series single-channel electronic load has a total of 5 models and provides 0~80V/ 0~500V voltage operating ranges and 250~700W power operating range. The series can be applied to R&D, quality control, ATE system and production test, including voltage source/current source test; switching power supply transient response; constant voltage mode for current limiting test; battery simulation; and battery discharge test.

The PEL-500 series provides a 5-digit digital display of voltage, current and power. Users can monitor the measurement data of the DUT at the same time. In order to facilitate users to evaluate whether the DUT can withstand the overshoot current, the PEL-500 series provides Surge test, which can simulate the boot overshoot current and the transient current from hot plugging. The built-in battery discharge test function can determine the conditions for stopping the discharge according to the test requirements of the DUT, including setting the discharge stop voltage (V_{batt}), discharge capacity (AH, WH) and stop discharge time.

Users can set the loading voltage/unloading voltage of the PEL-500 series for testing according to the characteristics of the DUT. When the output voltage of the DUT rises to the loading voltage value, the loading starts. When the output voltage drops to the unloading voltage, the loading ends. Users can use the GO/NG function to pre-set the judgment conditions according to the function and specifications of the DUT. The PEL-500 series will automatically generate the judgment results according to the set judgment conditions during the test.

Under the safety test requirements of the power supply, the PEL-500 series not only provides the Short test function, but also provides the automatic test function of overcurrent protection/overpower protection to simplify users' complicated manual operation and verify the OCP/OPP of the DUT's action points. The generated measurement results help users confirm whether the actual operating action points of the DUT for OCP/OPP are within the measurement regulations.

In addition to the function of providing load current waveforms to the oscilloscope via the BNC output terminal of Imonitor, the PEL-500 series also provides overvoltage, overcurrent, overpower and over temperature protection, and reverse polarity detection. When any one of them generates a trigger action, The PEL-500 series will have protective or reminding measures to protect the PEL-500 from damage due to abnormal operating ranges.

ORDERING INFORMATION

PEL-503-80-50	80V/50A/250W DC Electronic Load
PEL-504-80-70	80V/70A/350W DC Electronic Load
PEL-504-500-15	500V/15A/350W DC Electronic Load
PEL-507-80-140	80V/140A/700W DC Electronic Load
PEL-507-500-30	500V/30A/700W DC Electronic Load

PEL-507-500-30

Power rating: 7 → 700W

Maximum output current: 30 → 30A

Maximum output voltage: 500 → 500V

OPTIONAL ACCESSORIES

GTL-238	RS-232 Cable, 9-pin, M-F Type, 1000mm
GTL-246	USB Cable, USB 2.0, A-B Type, 1200mm

Note: * Regarding the product delivery date, please contact your regional sales representative.



Rear Panel



GTL-238 RS-232 Cable, 9-pin, M-F Type, 1000mm



Model	PEL-503-80-50	PEL-504-80-70	PEL-504-500-15	PEL-507-80-140	PEL-507-500-30						
INPUT RATINGS											
Power(Watt)	250 W	350 W	350 W	700 W	700 W						
Current(Ampere)	50 A	70 A	15 A	140 A	30 A						
Voltage(Volt)	80 V	80 V	500 V	80 V	500 V						
Min. Operating Voltage	1.0V @ 50A	1.2V @ 70A	6V @ 15A	0.9V @ 140A	3V @ 30A						
PROTECTIONS											
Over Power Protection(OPP)	≈262.5W	≈367.5W	≈367.5W	≈735W	≈735W						
Over Current Protection(OCP)	≈52.5A	≈73.5A	≈15.75A	≈147A	≈31.5A						
Over Voltage Protection(OVP)	≈84V	≈84V	≈525V	≈84V	≈525V						
Over Temp. Protection(OTP)	YES	YES	YES	YES	YES						
CC Mode											
Range	0-5.04-50.4A	0-7.02-70.2A	0-1.5-15A	0-14.04-140.4A	0-3-30A						
Resolution	0.084mA/0.84mA	0.117mA/1.17mA	0.025mA/0.25mA	0.234mA/2.34mA	0.05mA/ 0.5mA						
Accuracy	±0.1% of (SETTING + RANGE)										
CR Mode											
Range	0.016-1.6-96000Ω	0.0114-1.14-68400Ω	0.4-40-2400000Ω	0.0057-0.57-34200Ω	0.2-20-1200000Ω						
Resolution	26.666μΩ/0.010416mSiemens	19μΩ/0.014619mSiemens	666.667μΩ/0.416μSiemens	9.5μΩ/29.239μSiemens	333.334μΩ/0.833μSiemens						
Accuracy	±0.2% of (SETTING + RANGE)										
CV Mode											
Range	0-8.1-81V	0-8.1-81V	0-60-500V	0-8.1-81V	0-60-500V						
Resolution	0.135mV/1.35mV	0.135mV/1.35mV	1mV/10mV	0.135mV/1.35mV	1mV/10mV						
Accuracy	±0.05% of (SETTING + RANGE)										
CP Mode											
Range	0-25.02-250.2W (Imax=r1:5A, r2:50A)	0-35.04-350.4W (Imax=r1:7A, r2:70A)	0-35.04-350.4W (Imax=r1:1.5A, r2:15A)	0-70.02-700.2W (Imax=r1:14A, r2:140A)	0-70.02-700.2W (Imax=r1:3A, r2:30A)						
Resolution	0.417mW/4.17mW	0.584mW/5.84mW	0.584mW/5.84mW	1.167mW/11.67mW	1.17mW/117mW						
Accuracy	±0.5% of (SETTING + RANGE)										
Dynamic Mode											
THIGH/TLOW	10μS to 9.999 Sec										
Resolution	0.001/0.01/0.1/1mS										
Slew rate	L	0.032-2A/μs	0.0464-2.90A/μs	1-62.5mA/μs	0.0096-0.6A/μs	2-125mA/μs					
	H	3.2-200mA/μs	4.64-290mA/μs	10-625mA/μs	0.096-6A/μs	20-1250mA/μs					
Accuracy	±5%±10μs										
Measurement											
Voltage Read Back	Range (5 Digital)	0-8.1-81V	0-8.1-81V	0-60-500V	0-8.1-81V	0-60-500V					
	Resolution	0.135mV/1.35mV	0.135mV/1.35mV	1mV/10mV	0.135mV/1.35mV	1mV/10mV					
	Accuracy	±0.025% of (READING+ RANGE)									
Current Read Back	Range (5 Digital)	0-5.04-50.4A	0-7.02-70.2A	0-1.5-15A	0-14.04-140.4A	0-3-30A					
	Resolution	0.084mA/0.84mA	0.117mA/1.17mA	0.025mA/0.25mA	0.234mA/2.34mA	0.05mA/ 0.5mA					
	Accuracy	±0.1% of (READING+ RANGE)									
Power Read Back	Range (5 Digital)	25W	250W	35W	350W	35W	350W	70W	700W	70W	700W
	Resolution	0.001W	0.01W	0.001W	0.01W	0.001W	0.01W	0.001W	0.01W	0.001W	0.01W
	Accuracy	±0.1% of (READING + RANGE)									
Surge Test											
Surge & Normal current	0-50A	0-70A	0-15A	0-140A	0-30A						
Surge time	10-1000ms	10-1000ms	10-1000ms	10-1000ms	10-1000ms						
Surge step	1-5	1-5	1-5	1-5	1-5						
Battery Discharge Test											
UVP	0-81V	0-81V	0-500V	0-81V	0-500V						
Time	1-99999 Sec	1-99999 Sec	1-99999 Sec	1-99999 Sec	1-99999 Sec						
Capacity	0.1-19999.9AH/0.1-19999.9WH										
Others											
Load ON Voltage	0.1-25V		0.4-100V		0.1-25V	0.4-100V					
Accuracy	1% of (SETTING + RANGE)										
Load OFF Voltage	0-25V		0-100V		0-25V	0-100V					
Accuracy	0.05% of (SETTING + RANGE)										
Imonitor (Non-isolated)	5.04 A/V	7.02 A/V	1.5 A/V	14.04 A/V	3 A/V						
Current Monitor	Full scale: 10V										
Accuracy	0.5% of (SETTING + RANGE)										
Typical Short Resistance	0.018Ω	0.0169Ω	0.367Ω	0.0053Ω	0.087Ω						
Max. short Current	50A	70A	15A	140A	30A						
Power input	115/230 Vac±10%, 50/60Hz										
Interface (Standard)	USB/RS232										
Power Consumption	40 VA			60 VA							
Dimension (HxWxD)	205 x 123 x 477mm	205 x 123 x 477mm	205 x 123 x 477mm	205 x 231 x 480mm	205 x 231 x 480mm						
Weight	5.3kg	5.3kg	5.3kg	10.3kg	10.3kg						

AC & DC Electronic Load



AEL-5000 Series

NEW



FEATURES

- * Turbo Mode (Multiplier Mode) Can Withstand up to 2 Times the Rating Current and Power of the Electronic Load in a Short Period of Time
- * Operating Mode: CC, linear CC, CR, CV, CP and AC Rectifier Loads
- * Measurement Items: Voltage Value(Vrms, Vpeak, Vmax., Vmin), Current Value(Irms, Ipeak, Imax., Imin.), Watt Value, Volt-ampere Value(VA), Frequency Value, Crest Factor, Power Factor, Voltage Total Distortion(V THD, VH), Current Total Distortion (I THD, IH), Etc
- * Eight Units Connected in Parallel up to 180kW for Single-phase and 540kW for Three-phase
- * Support Loading and Unloading Angle Control, Loading and Unloading Angle Control Can be set at the Full Range of 0-359 Degrees
- * Support Positive Half Cycle or Negative Half Cycle Load
- * Support SCR/TRIAC Current Phase Modulation Waveform, 90-degree Trailing Edge and Leading Edge
- * Support the Capacitive Load (Inrush Current)when the Power Supply is Turned on and the Transient Current (Surge Current) Test when the Load is Suddenly Connected (Hot Plug-in) During Operation
- * Crest Factor Range: 1.414~5.0
- * Power Factor Range: 0.1~1.0 Leading or Trailing
- * Frequency Range: DC, 40~440Hz (AEL-5003-480-18.75/AEL-5004-480-28: DC, 40~70Hz), and 800Hz and 1kHz Need to be Customized
- * Optional Control Interfaces: GPIB, RS-232, USB, LAN

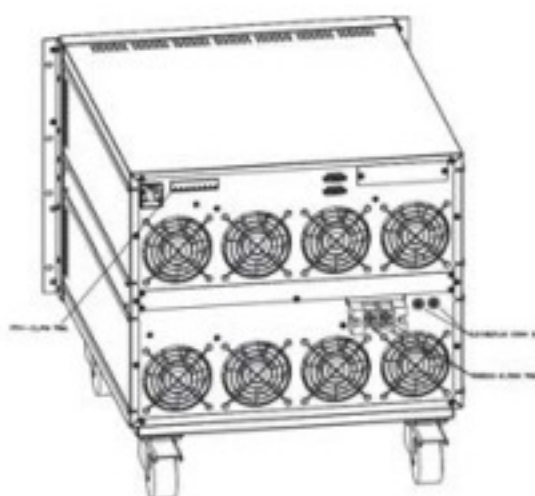
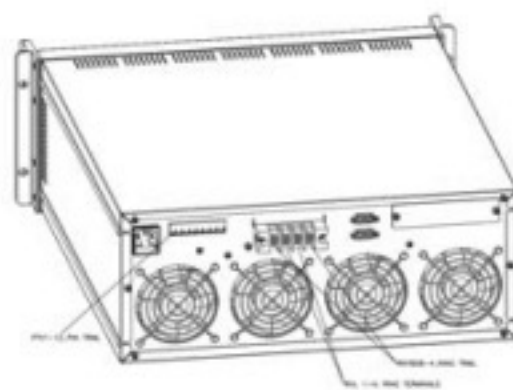

GW Instek launches 20 models of the AEL-5000 series AC/DC electronic loads depending on the power range. The power range of a single unit is from 1875W to 22500W, and up to 8 units can be connected in parallel. The maximum power of single-phase parallel connection can reach 180kW, and the total power of 3-phase can reach 540kW, which are suitable for UPS, Inverter/Breaker, AC Power Source, Battery, Fuse/Breaker, DC Power Source and other applications.

The AEL-5000 series has built-in precision measurement circuits such as 16-bit A/D and DSP to provide accurate measurement items, which include voltage root mean square value (Vrms), current root mean square value (Arms), and watt value (Watt), volt-ampere (VA), crest factor (CF), power factor (PF), total harmonic distortion (THD), voltage total harmonic distortion (VTHD), current total harmonic distortion (ITHD), peak current (Ipeak), maximum current (Amax), minimum current (Amin), maximum voltage (Vmax), minimum voltage (Vmin), time measurement. In addition, built-in test modes include UPS Efficiency, PV Inverter Efficiency, UPS Back-up time, Battery Discharge time, UPS transfer time, Fuse/Breaker Trip/Non-Trip, short circuit simulation, OCP, OPP and other test modes.

The AEL-5000 series has the Turbo mode (ON or OFF can be selected) design, which can increase the current and power of the electronic load by 2 times in one second. For test applications that require transient high power and large current such as transient overload test of protective components or short circuit of Fuse/Breaker and AC power supply, OCP and OPP tests etc.. The Turbo mode provides the most economical solution.

The AEL-5000 series also supports the Load On startup function (pre-set Load On). When the inverter or uninterruptible power supply is turned on, the series directly loads the set load current to verify that whether startup of the inverter or uninterrupted power supply connecting to the electrical appliance is stable. At the same time, the Load On start function can also set positive half cycle or negative half load to verify whether the output voltage of the inverter or uninterruptible power supply remains stable when the actual electrical appliance only has a positive half cycle or negative half cycle load current. Control load angle and unload angle can also be set (range 0~359 degrees) to verify the stability of the transient response of the inverter or uninterruptible power supply when the appliance is plugged in and unplugged. In addition, the series also supports SCR/TRIAC current phase modulation waveform, 90 degree Trailing Edge and Leading Edge settings.

For the application of the adjustable bandwidth (BW) function, when the bandwidth of the DUT does not match the bandwidth of the AEL-5000 series, there will be oscillations. Users can reduce the BW setting value accordingly to meet the response speed of the DUT. Inrush Current verifies whether the transient response of the inverter output voltage is stable when the electrical appliance is turned on (Inrush Current) and when the electrical appliance is suddenly connected (Surge Current).

The entire series of AEL-5000 provides over-voltage warning, over-current, over-power, and over-temperature protection. Analog Input terminal can control constant current, constant power and other working modes through external voltage. Vmonitor/Imonitor terminal is used to connect external voltage/current monitoring device. In addition, a variety of optional control interfaces are provided such as GPIB, RS-232, USB, and LAN to meet the needs of system integration.

ORDERING INFORMATION

AEL-5002-350-18.75	350V/18.75A/1875W	AC & DC Electronic Load
AEL-5003-350-28	350V/28A/2800W	AC & DC Electronic Load
AEL-5004-350-37.5	350V/37.5A/3750W	AC & DC Electronic Load
AEL-5006-350-56	350V/56A/5600W	AC & DC Electronic Load
AEL-5008-350-75	350V/75A/7500W	AC & DC Electronic Load
AEL-5012-350-112.5	350V/112.5A/11250W	AC & DC Electronic Load
AEL-5015-350-112.5	350V/112.5A/15000W	AC & DC Electronic Load
AEL-5019-350-112.5	350V/112.5A/18750W	AC & DC Electronic Load
AEL-5023-350-112.5	350V/112.5A/22500W	AC & DC Electronic Load
AEL-5002-425-18.75	425V/18.75A/1875W	AC & DC Electronic Load
AEL-5003-425-28	425V/28A/2800W	AC & DC Electronic Load
AEL-5004-425-37.5	425V/37.5A/3750W	AC & DC Electronic Load
AEL-5006-425-56	425V/56A/5600W	AC & DC Electronic Load
AEL-5008-425-75	425V/75A/7500W	AC & DC Electronic Load
AEL-5012-425-112.5	425V/112.5A/11250W	AC & DC Electronic Load
AEL-5015-425-112.5	425V/112.5A/15000W	AC & DC Electronic Load
AEL-5019-425-112.5	425V/112.5A/18750W	AC & DC Electronic Load
AEL-5023-425-112.5	425V/112.5A/22500W	AC & DC Electronic Load
AEL-5003-480-18.75	480V/18.75A/2800W	AC & DC Electronic Load
AEL-5004-480-28	480V/28A/3750W	AC & DC Electronic Load

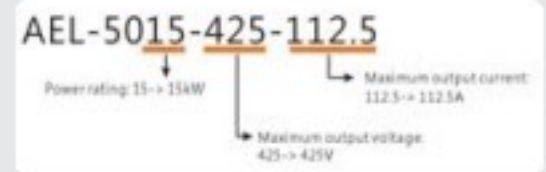

STANDARD ACCESSORIES

AEL-5000 Series operation manual
 HD-DSUB : 15pin MALE to MALE 150cm x 1
 PTV1-12 PIN TRML : Please refer to Fig.1 x 6

AEL-5002-xxx-18.75/AEL-5003-xxx-28/AEL-5004-xxx-37.5
 PVL 1-4 RING TERMINALS : Please refer to Fig.4 x 2
 RNYBS8-4 RING TRML : Please refer to Fig.5 x 2

AEL-5006-xxx-56/AEL-5008-xxx-78/AEL-5012-xxx-112.5/
 AEL-5015-xxx-112.5/AEL-5019-xxx-112.5/AEL-5023-xxx/112.5
 SLS10B RED PLUG CONN 20A RED : Please refer to Fig.2;
 The terminal is used for Vsense x 1
 SLS10B BLK PLUG CONN 20A BLK : Please refer to Fig.2;
 The terminal is used for Vsense x 1
 RNB S22-6 RING TRML, #4 : Please refer to Fig.3 x 2

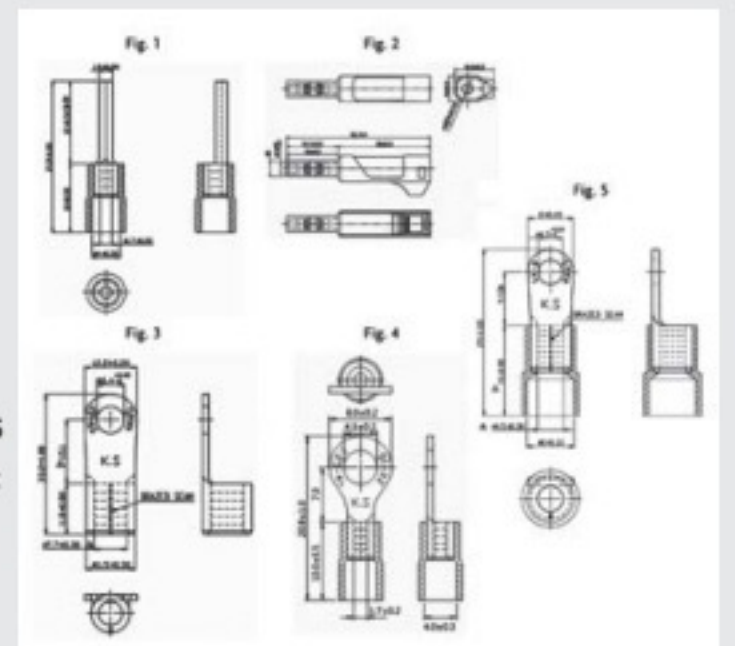

OPTIONAL ACCESSORIES

PEL-022	GPIB Card	PEL-030	GPIB+RS-232 Card
PEL-023	RS-232 Card	GTL-246	USB Cable, USB 2.0, A-B Type, 1200mm
PEL-024	LAN Card	GTL-248	GPIB Cable, Double Shielded, 2000mm
PEL-025	USB Card	GTL-250	GPIB Cable, Double Shielded, 600mm
PEL-028	HANDLES, U-shaped handle(fixed to the bracket)(for AEL-5006/5008/5012/5015)		
PEL-029	HANDLES Rack Accessories(for AEL-5002/5003/5004)		

Note: * Regarding the product delivery date, please contact your regional sales representative.



AEL-5002-350-18.75 **AEL-5006-350-56** **AEL-5012-350-112.5** **AEL-5015-350-112.5** **AEL-5019-350-112.5** **AEL-5023-350-112.5**
AEL-5003-350-28 **AEL-5008-350-75** **AEL-5012-425-112.5** **AEL-5015-425-112.5** **AEL-5019-425-112.5** **AEL-5023-425-112.5**
AEL-5004-350-37.5 **AEL-5006-425-56**
AEL-5002-425-18.75 **AEL-5008-425-75**
AEL-5003-425-28
AEL-5004-425-37.5
AEL-5003-480-18.75
AEL-5004-480-28

MODEL	Power (W)		Current(Ampere)		Voltage(Volt)
	Turbo OFF	Turbo ON	Turbo OFF	Turbo ON	
AEL-5002-350-18.75	1875 W	3750W (x2)*	18.75 Arms / 56.25Apeak	37.5Arms/56.25Apeak (x2)*	50~350Vrms / 500Vdc
AEL-5003-350-28	2800W	5600W (x2)*	28 Arms / 84Apeak	56Arms/84Apeak (x2)*	
AEL-5004-350-37.5	3750 W	7500W (x2)*	37.5 Arms / 112.5Apeak	75.0Arms/112.5Apeak (x2)*	
AEL-5002-425-18.75	1875 W	3750W (x2)*	18.75 Arms / 56.25Apeak	37.5Arms/56.25Apeak (x2)*	50~425Vrms / 600Vdc
AEL-5003-425-28	2800W	5600W (x2)*	28 Arms / 84Apeak	56Arms/84Apeak (x2)*	
AEL-5004-425-37.5	3750 W	7500W (x2)*	37.5 Arms / 112.5Apeak	75.0Arms/112.5Apeak (x2)*	
AEL-5006-350-56	5600 W	11200W (x2)*	56.0 Arms / 168Apeak	112.0Arms/ 168Apeak (x2)*	50~350Vrms / 500Vdc
AEL-5008-350-75	7500 W	15000W (x2)*	75.0 Arms / 225Apeak	150.0Arms/225Apeak (x2)*	
AEL-5012-350-112.5	11250W	22500W (x2)*	112.5 Arms / 337.5Apeak	225Arms/337.5Apeak (x2)*	
AEL-5015-350-112.5	15000W	30000W (x2)*	112.5 Arms / 337.5Apeak	225Arms/337.5Apeak (x2)*	
AEL-5019-350-112.5	18750W	37500W (x2)*	112.5 Arms / 337.5Apeak	225Arms/337.5Apeak (x2)*	
AEL-5023-350-112.5	22500W	45000W (x2)*	112.5 Arms / 337.5Apeak	225Arms/337.5Apeak (x2)*	
AEL-5006-425-56	5600 W	11200W (x2)*	56.0 Arms / 168Apeak	112.0Arms/ 168Apeak (x2)*	50~425Vrms / 600Vdc
AEL-5008-425-75	7500 W	15000W (x2)*	75.0 Arms / 225Apeak	150.0Arms/225Apeak (x2)*	
AEL-5012-425-112.5	11250W	22500W (x2)*	112.5 Arms / 337.5Apeak	225Arms/337.5Apeak (x2)*	
AEL-5015-425-112.5	15000W	30000W (x2)*	112.5 Arms / 337.5Apeak	225Arms/337.5Apeak (x2)*	
AEL-5019-425-112.5	18750W	37500W (x2)*	112.5 Arms / 337.5Apeak	225Arms/337.5Apeak (x2)*	
AEL-5023-425-112.5	22500W	45000W (x2)*	112.5 Arms / 337.5Apeak	225Arms/337.5Apeak (x2)*	
AEL-5003-480-18.75	2800W	5600W (x2)*	18.75 Arms / 56.25Apeak	37.5Arms/56.25Apeak (x2)*	50~480Vrms / 700Vdc
AEL-5004-480-28	3750 W	7500W (x2)*	28 Arms / 84Apeak	56Arms/84Apeak (x2)*	

* Power and current boost rate of Turbo ON

AC & DC Electronic Load

SPECIFICATIONS

MODEL	AEL-5002-350-18.75	AEL-5003-350-28	AEL-5004-350-37.5	AEL-5002-425-18.75	AEL-5003-425-28	AEL-5004-425-37.5
Power (W)	1875 W	2800W	3750 W	1875 W	2800W	3750 W
Current(Ampere)	18.75 Arms / 56.25Apeak	28 Arms / 84Apeak	37.5 Arms / 112.5Apeak	18.75 Arms / 56.25Apeak	28 Arms / 84Apeak	37.5 Arms / 112.5Apeak
Voltage(Volt)	50-350Vrms / 500Vdc			50-425Vrms / 600Vdc		
FREQUENCY Range	DC, 40-440Hz(CC,CP Mode), DC-440Hz(LIN,CR,CV Mode)			DC, 40-440Hz(CC,CP Mode), DC-440Hz(LIN,CR,CV Mode)		
PROTECTIONS						
Over Power Protection	±1968.75Wrms or Programmable	±2940Wrms or Programmable	±3937.5Wrms or Programmable	±1968.75Wrms or Programmable	±2940Wrms or Programmable	±3937.5Wrms or Programmable
Over Current Protection	±19.687 Arms or Programmable	±28.4 Arms or Programmable	±39.375 Arms, or Programmable	±19.687 Arms or Programmable	±28.4 Arms or Programmable	±39.375 Arms, or Programmable
Over Voltage Protection	±367.5 Vrms / 525Vdc			±446.25 Vrms/630Vdc		
Over Temp. Protection	Yes			Yes		
OPERATION MODE						
Constant Current Mode for Sine-Wave						
Range	0-18.75A	0-28A	0-37.5A	0-18.75A	0-28A	0-37.5A
Resolution	0.3125mA/16bits	0.5mA/16bits	0.625mA/16bits	0.3125mA/16bits	0.5mA/16bits	0.625mA/16bits
Accuracy	± (0.1% of setting + 0.2% of range) @ 50/60Hz, ± 0.5% of (setting + range) @ DC and 400Hz			± (0.1% of setting + 0.2% of range) @ 50/60Hz, ± 0.5% of (setting + range) @ DC and 400Hz		
Linear Constant Current Mode for Sine-Wave, Square-Wave or Quasi-Square Wave, PWM Wave						
Range	0-18.75A	0-28A	0-37.5A	0-18.75A	0-28A	0-37.5A
Resolution	0.3125mA/16bits	0.5mA/16bits	0.625mA/16bits	0.3125mA/16bits	0.5mA/16bits	0.625mA/16bits
Accuracy	± (0.1% of setting + 0.2% of range) @ 50/60Hz, ± 0.5% of (setting + range) @ DC and 400Hz			± (0.1% of setting + 0.2% of range) @ 50/60Hz, ± 0.5% of (setting + range) @ DC and 400Hz		
Constant Resistance Mode						
Range	3.2 ohm - 64k ohm	2.0 ohm - 40k ohm	1.6 ohm - 32k ohm	3.2 ohm - 64k ohm	2.0 ohm - 40k ohm	1.6 ohm - 32k ohm
Resolution*1	0.0052083mS/16bits	0.0083333mS/16bits	0.010416mS/16bits	0.0052083mS/16bits	0.0083333mS/16bits	0.010416mS/16bits
Accuracy	±0.2% of (setting + range) @ 50/60Hz, ± (0.5% of setting + 2% of range) @ DC and 400Hz			±0.2% of (setting + range) @ 50/60Hz, ± (0.5% of setting + 2% of range) @ DC and 400Hz		
Constant Voltage Mode						
Range	50-350Vrms / 500Vdc			50-425Vrms / 600Vdc		
Resolution	0.01V			0.1V		
Accuracy	±(0.1% of setting + 0.1% of range)			±(0.1% of setting + 0.1% of range)		
Constant Power Mode						
Range	1875W	2800W	3750W	1875W	2800W	3750W
Resolution	0.1W	0.1W	0.1W	0.1W	0.1W	0.1W
Accuracy*4	±0.5% of (setting + range) @ 50/60Hz, ±2% of (setting + range)			±0.5% of (setting + range) @ 50/60Hz, ±2% of (setting + range)		
CREST FACTOR (CC & CP MODE ONLY)						
Range	0-2.5			0-2.5		
Resolution	0.1			0.1		
Accuracy	(0.5% / Irms) + 1% F.S.			(0.5% / Irms) + 1% F.S.		
POWER FACTOR (CC & CP MODE ONLY)						
Range	0-1 Lag or Lead			0-1 Lag or Lead		
Resolution	0.01			0.01		
Accuracy	1% F.S.			1% F.S.		
TEST MODE						
UPS Efficient Measurement		Non-Linear Mode			Non-Linear Mode	
Operating Frequency		Auto: 40-440Hz			Auto: 40-440Hz	
Current Range	0-18.75A	0-28A	0-37.5A	0-18.75A	0-28A	0-37.5A
PF Range	0-1			0-1		
Measuring Efficiency For PV Systems, Power Conditions for THD 80%		Resistive + Non-Linear Mode			Resistive + Non-Linear Mode	
Operating Frequency		Auto: 40-440Hz			Auto: 40-440Hz	
Current Range	0-18.75A	0-28A	0-37.5A	0-18.75A	0-28A	0-37.5A
Resistive Range	3.2 ohm - 64k ohm	2.0 ohm - 40k ohm	1.6 ohm - 32k ohm	3.2 ohm - 64k ohm	2.0 ohm - 40k ohm	1.6 ohm - 32k ohm
UPS Back-Up Function(CC,UN,CP)						
UVP (VTH)		50-350Vrms / 500Vdc			50-425Vrms / 600Vdc	
UPS Back-Up Time		1-99999 Sec. (>27H)			1-99999 Sec. (>27H)	
Battery Discharge Function(CC,UN,CP)						
UVP (VTH)		50-350Vrms / 500Vdc			50-425Vrms / 600Vdc	
Battery Discharge Time		1-99999 Sec. (>27H)			1-99999 Sec. (>27H)	
UPS Transfer Time						
Current Range	0-18.75A	0-28A	0-37.5A	0-18.75A	0-28A	0-37.5A
UVP (VTH)		2.5V			2.5V	
Time Range						
Fuse Test Mode						
Max. Current	Turbo OFF(CC1-3) Turbo ON(CC1)	18.75Arms	28.0Arms	37.5Arms	18.75Arms	28.0Arms
	Turbo ON(CC1-2)	37.5Arms (x2)*3	56.0Arms (x2)*3	75.0Arms (x2)*3	37.5Arms (x2)*3	56.0Arms (x2)*3
Trip & Non-Trip Time	Turbo OFF(Time1-3) Turbo ON(Time1-2) Turbo ON(Time3)		0.01-333.33 Sec. 0.01-0.5 Sec. 0.01-600.00 Sec.		0.01-333.33 Sec. 0.01-0.5 Sec. 0.01-600.00 Sec.	
OFF Time		0.1-999.9 Sec.			0.1-999.9 Sec.	
Meas. Accuracy		±0.003 Sec.			±0.003 Sec.	
Repeat Cycle		0-99999			0-99999	
Short/OPP/OCP Test Function						
Short Time	Turbo OFF Turbo ON		0.1-10Sec. or Cont. 0.1-15Sec.		0.1-10Sec. or Cont. 0.1-15Sec.	
OPP/OCP Step Time	Turbo OFF Turbo ON		100ms 100ms, up to 10 Steps		100ms 100ms, up to 10 Steps	
OCP Istop	Turbo OFF Turbo ON	18.75Arms 37.5Arms	28.0Arms 56.0Arms	37.5Arms 75.0Arms	18.75Arms 37.5Arms	28.0Arms 56.0Arms
OPP Pstop	Turbo OFF Turbo ON	1875W 3750W	2800W 5600W	3750W 7500W	1875W 3750W	2800W 5600W
Programmable Inrush Current Simulation: Inrush - Istop / Tstop						
Istart, Inrush Start Current	0-37.5A	0-56A	0-75A	0-37.5A	0-56A	0-75A
Inrush Step Time		0.1ms-100ms			0.1ms-100ms	
Istop, Inrush Stop Current	0-18.75A	0-28A	0-37.5A	0-18.75A	0-28A	0-37.5A
Programmable Surge Current Simulation: S1/T1 - S2/T2 - S3/T3						
S1 and S2 Current	0-37.5A	0-56A	0-75A	0-37.5A	0-56A	0-75A
T1 and T2 Time		0.01-0.55Sec.			0.01-0.55Sec.	
S3 Current	0-18.75A	0-28A	0-37.5A	0-18.75A	0-28A	0-37.5A
T3 Time		0.01-9.99Sec. or Cont.			0.01-9.99Sec. or Cont.	
MEASUREMENTS						
VOLTAGE READBACK V METER						
Range	300V			600V		
Resolution	0.01V			0.01V		
Accuracy	±0.05% of (reading + range)			±0.05% of (reading + range)		
Parameter	Vrms, V Max/Min, +/-Vpk			Vrms, V Max/Min, +/-Vpk		
CURRENT READBACK A METER						
Range	9.375Arms/18.75Arms	14Arms/28Arms	18.75Arms/37.5Arms	9.375Arms/18.75Arms	14Arms/28Arms	18.75Arms/37.5Arms
Resolution	0.2mA/0.4mA	0.3mA/0.6mA	0.4mA/0.8mA	0.2mA/0.4mA	0.3mA/0.6mA	0.4mA/0.8mA
Accuracy	±0.05% of (reading + range) @ 50/60Hz			±0.05% of (reading + range) @ 50/60Hz		
Parameter	Irms, I Max/Min, +/-Ipk			Irms, I Max/Min, +/-Ipk		
WATT READBACK W METER						
Range	1875W	2800W	3750W	1875W	2800W	3750W
Resolution	0.03125W	0.05W	0.0625W	0.03125W	0.05W	0.0625W
Accuracy*4	±0.5% of (reading + range) @ 50/60Hz, ±2% of (reading + range)			±0.5% of (reading + range) @ 50/60Hz, ±2% of (reading + range)		
VA METER						
Parameter	VrmsxArms Correspond To Vrms and Arms			VrmsxArms Correspond To Vrms and Arms		
POWER FACTOR METER						
Range	+/- 0.000-1.000			+/- 0.000-1.000		
Accuracy	±(0.002±0.001/PP)*F			±(0.002±0.001/PP)*F		
Frequency METER(Hz)						
Range	DC, 40-440Hz			DC, 40-440Hz		
Accuracy	0.1%			0.1%		
Other Parameter METER	VA, VAR, CF, I, Ipeak, Imax, Imin, Vmax, Vmin, IHD, VHD, ITHD, VTHD					
OTHERS						
Start up Loading	Yes, Power on loading during Inverter / UPS start up			Yes, Power on loading during Inverter / UPS start up		
Load ON / OFF Angle	0 - 359 degree can be programmed for the angle of load ON and load OFF loading			0 - 359 degree can be programmed for the angle of load ON and load OFF loading		
Half Cycle and SCR/TRIAC Loading	Positive or Negative half cycle, 90° Trailing edge or Leading edge current waveform can be programmed			Positive or Negative half cycle, 90° Trailing edge or Leading edge current waveform can be programmed		
Master/Slave (3 Phase or Parallel Application)	Yes, 1 master and upto 7 slave units			Yes, 1 master and upto 7 slave units		
External Programming Input (OPTION)	F.S / 10Vdc, Resolution 0.1V			F.S / 10Vdc, Resolution 0.1V		
External SYNC Input	TTL			TTL		
Vmonitor (Isolated)	±500V / ±10V			±600V / ±10V		
Imonitor (Isolated)	±84Apk / ±10Vpk			±112.5Apk / ±10Vpk		
Interface (OPTION)	GPIB ; RS-232 ; LAN ; USB			GPIB ; RS-232 ; LAN ; USB		
MAX. Power Consumption	150VA			150VA		
Operation Temperature *2	0 - 40 °C			0 - 40 °C		
Current of Input Impedance(mA)@50/60Hz ; @ 400Hz	-V*0.3 ; -V*2.2	-V*0.45 ; -V*3.3	-V*0.6 ; -V*4.4	-V*0.3 ; -V*2.2	-V*0.45 ; -V*3.3	-V*0.6 ; -V*4.4
Dimension(H x W x D)	177 x 440 x 552.6 mm	177 x 440 x 552.6 mm	177 x 440 x 552.6 mm	177 x 440 x 552.6 mm	177 x 440 x 552.6 mm	177 x 440 x 552.6 mm
Weight	21.5kg	27.5kg	33.5kg	21.5kg	27.5kg	33.5kg

*1 ms (millisiemens) is the unit of conductance(G), one siemens equal to 1/Ω

*2 Operating temperature range is 0-40°C, all specification apply for 25°C±5°C, Except as noted

*3 Turbo mode for up to 2X Current rating & Power rating support Fuse, Short/OCP/OPP test function

*4 The specification apply for current less than 20Arms

* All specifications apply for 50/60Hz

* All specifications subject to change without notice

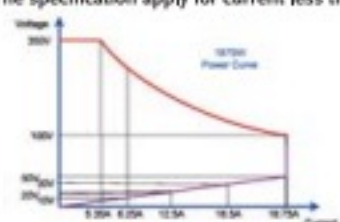

AEL-5002-350-18.75

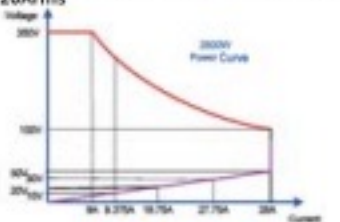

AEL-5003-350-28

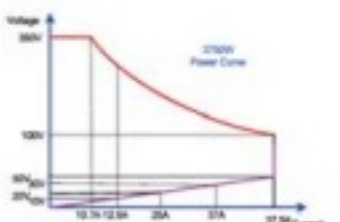

AEL-5004-350-37.5

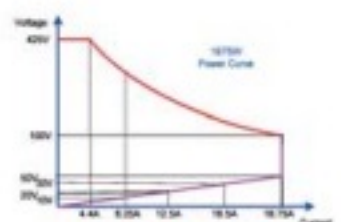

AEL-5002-425-18.75

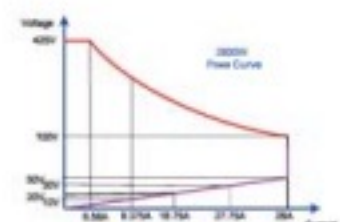

AEL-5003-425-28

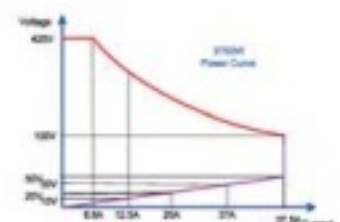

AEL-5004-425-37.5

SPECIFICATIONS

MODEL	AEL-5006-350-56	AEL-5008-350-75	AEL-5012-350-112.5	AEL-5015-350-112.5	AEL-5019-350-112.5	AEL-5023-350-112.5	
Power (W)	5600W	7500W	11250W	15000W	18750W	22500W	
Current(Ampere)	56Arms / 168Apeak	75Arms / 225Apeak	112.5Arms / 337.5Apeak	112.5Arms / 337.5Apeak	112.5Arms / 337.5Apeak	112.5Arms / 337.5Apeak	
Voltage(Volt)	50-350Vrms / 500Vdc						
FREQUENCY Range	DC, 40-440Hz(CC,CP Mode) , DC-440Hz(LIN,CR,CV Mode)						
PROTECTIONS							
Over Power Protection	≠ 5880Wrms or Programmable	≠ 7875Wrms or Programmable	≠ 11812.5Wrms or Programmable	≠ 11812.5Wrms or Programmable	≠ 19687.5Wrms or Programmable	≠ 23625Wrms or Programmable	
Over Current Protection	≠ 58.8Arms, or Programmable	≠ 78.75Arms, or Programmable	≠ 118.125Arms or Programmable	≠ 118.125Arms or Programmable	≠ 118.125Arms or Programmable	≠ 118.125Arms or Programmable	
Over Voltage Protection	≠ 367.5Vrms/525Vdc						
Over Temp. Protection	Yes						
OPERATION MODE							
Constant Current Mode for Sine-Wave							
Range	0-56A	0-75A	0-112.5A	0-112.5A	0-112.5A	0-112.5A	
Resolution	1mA/16bits	1.25mA/16bits	1.875mA/16bits	1.875mA/16bits	1.875mA/16bits	1.875mA/16bits	
Accuracy	± 0.1% of setting + 0.2% of range @ 50/60Hz , ± 0.5% of (setting + range) @ DC and 400Hz						
Linear Constant Current Mode for Sine-Wave, Square-Wave or Quasi-Square Wave, PWM Wave							
Range	0-56A	0-75A	0-112.5A	0-112.5A	0-112.5A	0-112.5A	
Resolution	1mA/16bits	1.25mA/16bits	1.875mA/16bits	1.875mA/16bits	1.875mA/16bits	1.875mA/16bits	
Accuracy	± 0.1% of setting + 0.2% of range @ 50/60Hz , ± 0.5% of (setting + range) @ DC and 400Hz						
Constant Resistance Mode							
Range	1ohm - 20kohm	0.8ohm - 16kohm	0.533ohm - 10.666kohm	0.533ohm - 10.666kohm	0.533ohm - 10.666kohm	0.533ohm - 10.666kohm	
Resolution ¹⁾	0.016666mS/16bits	0.020832mS/16bits	0.031248mS/16bits	0.031248mS/16bits	0.031248mS/16bits	0.031248mS/16bits	
Accuracy	± 0.2% of (setting + range) @ 50/60Hz , ± 0.5% of (setting + range) @ DC and 400Hz						
Constant Voltage Mode							
Range	50-350Vrms / 500Vdc						
Resolution	0.1V						
Accuracy	± 0.2% of (setting + range) @ 50/60Hz						
Constant Power Mode							
Range	5600W	7500W	11250W	15000W	18750W	22500W	
Resolution	0.1W	0.1W	1W	1W	1W	1W	
Accuracy ^{1,4}	± 0.5% of (setting + range) @ 50/60Hz , ± 2% of (setting + range)						
CRIST FACTOR (CC & CP MODE ONLY)							
Range	√2-5						
Resolution	0.1						
Accuracy	± 0.5% / Irms + 1% F.S						
POWER FACTOR (CC & CP MODE ONLY)							
Range	0-1 Lag or Lead						
Resolution	0.01						
Accuracy	1% F.S						
TEST MODE							
UPS Efficient Measurement							
Operating Frequency	Non-Linear Mode						
Current Range	0-56A	0-75A	0-112.5A	0-112.5A	0-112.5A	0-112.5A	
PF Range	0-1						
Measuring Efficiency For PV Systems, Power Conditioners for THD 50%							
Operating Frequency	Resistive + Non-Linear Mode						
Current Range	0-56A	0-75A	0-112.5A	0-112.5A	0-112.5A	0-112.5A	
Resistive Range	1ohm - 20kohm	0.8ohm - 16kohm	0.533ohm - 10.666kohm	0.533ohm - 10.666kohm	0.533ohm - 10.666kohm	0.533ohm - 10.666kohm	
UPS Back-Up Function(CC, LIN, CR, CV)							
UVP (VTH)	50-350Vrms / 500Vdc						
UPS Back-Up Time	1-99999 Sec. (>27H)						
Battery Discharge Function(CC, LIN, CR, CV)							
UVP (VTH)	50-350Vrms / 500Vdc						
Battery Discharge Time	1-99999 Sec. (>27H)						
UPS Transfer Time							
Current Range	0-56A	0-75A	0-112.5A	0-112.5A	0-112.5A	0-112.5A	
UVP (VTH)	2.5V						
Time range	0.15ms-999.99ms						
Fuse Test Mode							
Max. Current	Turbo OFF(CC1-5) Turbo ON(CC) Turbo ON(CC1-2)	56Arms 112Arms (x2) ¹⁾	75Arms 150Arms (x2) ¹⁾	112.5Arms 225Arms (x2) ¹⁾	112.5Arms 225Arms (x2) ¹⁾	112.5Arms 225Arms (x2) ¹⁾	
Trip & Non-Trip Time	Turbo OFF(Time1-3) Turbo ON(Time1-2) Turbo ON(Time3)	0.01-333.33 Sec. 0.01-0.50 Sec. 0.01-600.00 Sec.				0.1-999.9 Sec.	± 0.003 Sec. 0-99999
OFF Time							
Meas. Accuracy							
Repeat Cycle							
Short/OPP/OCF Test Function							
Short Time	Turbo OFF Turbo ON	0.1-10Sec. or Cont. 0.1-15Sec.				100ms	100ms
OPP/OCF Step Time	Turbo OFF Turbo ON	100ms, up to 10 Steps					
OCF Istop	Turbo OFF Turbo ON	56Arms 112Arms	75Arms 150Arms	112.5Arms 225Arms	112.5Arms 225Arms	112.5Arms 225Arms	
OPP Pstop	Turbo OFF Turbo ON	5600W 11200W	7500W 15000W	11250W 22500W	15000W 30000W	18750W 37500W	
Programmable Inrush Current Simulation: Inrush - Istop / Tstop							
Inrush Start Current	0-112A	0-150A	0-225A	0-225A	0-225A	0-225A	
Inrush Stop Time	0.1ms-100ms						
Inrush Stop Current	0-56A	0-75A	0-112.5A	0-112.5A	0-112.5A	0-112.5A	
Programmable Surge Current Simulation: S1/T1 - S2/T2 - S3/T3							
S1 and S2 Current	0-112A	0-150A	0-225A	0-225A	0-225A	0-225A	
T1 and T2 Time	0.01-0.5Sec.						
S3 Current	0-56A	0-75A	0-112.5A	0-112.5A	0-112.5A	0-112.5A	
T3 Time	0.01-0.99Sec. or Cont.						
MEASUREMENTS							
VOLTAGE READBACK V METER							
Range	500V						
Resolution	0.01V						
Accuracy	± 0.05% of (reading + range)						
Parameter	Vrms, V Max/Min, +/-Vpk						
CURRENT READBACK A METER							
Range	28Arms/56Arms	37.5Arms/75Arms	56.25Arms/112.5Arms	56.25Arms/112.5Arms	56.25Arms/112.5Arms	56.25Arms/112.5Arms	
Resolution	0.6mA/1.2mA	0.8mA/1.6mA	1.2mA/2.4mA	1.2mA/2.4mA	1.2mA/2.4mA	1.2mA/2.4mA	
Accuracy	± 0.1% of (reading + range) @ 50/60Hz						
Parameter	Irms, I Max/Min, +/-Ipk						
WATT READBACK W METER							
Range	5600W	7500W	11250W	15000W	18750W	22500W	
Resolution	0.1W	0.125W	0.1875W	0.25W	0.3125W	0.375W	
Accuracy ^{1,4}	± 0.5% of (reading + range) @ 50/60Hz , ± 2% of (reading + range)						
VA METER	VrmsxArms Correspond To Vrms and Arms						
Power Factor METER							
Range	+/- 0.000-1.000						
Accuracy	± (0.002+(0.001/PF))^2						
Frequency METER(Hz)							
Range	DC, 40-440Hz						
Accuracy	0.1%						
Other Parameter METER	VA, VAR, CF, I, Ipeak, Imax, Imin, Vmax, Vmin, IHD, VHD, ITHD, VTHD						
OTHERS							
Start up Loading	Yes, Power on loading during Inverter / UPS start up						
Load ON / OFF Angle	0-359 degree can be programmed for the angle of load ON and load OFF loading						
Half Cycle and SCR/TRIAC Loading	Positive or Negative half cycle, 90° Trailing edge or Leading edge current waveform can be programmed						
Master/Slave (3 Phase or Parallel Application)	Yes, 1 master and upto 7 slave unit						
External Programming Input (OPTION)	F.S / 10Vdc, Resolution 0.1V						
External SYNC Input	TTL						
Vmonitor (Isolated)	± 500V / ± 10V						
Imonitor (Isolated)	± 168Apk / ± 10Vpk	± 225Apk / ± 10Vpk	± 337.5Apk / ± 10Vpk	± 337.5Apk / ± 10Vpk	± 337.5Apk / ± 10Vpk	± 337.5Apk / ± 10Vpk	
Interface (OPTION)	GPIB ; RS-232 ; LAN ; USB						
MAX. Power Consumption	270VA	270VA	390VA	510VA	630VA	750VA	
Operation Temperature ¹⁾	0-40 °C						
Current of Input Impedance(mA)@50/60Hz ; @ 400Hz	-V ¹⁾ 0.9 ; -V ¹⁾ 6.6	-V ¹⁾ 1.2 ; -V ¹⁾ 8.8	-V ¹⁾ 1.8 ; -V ¹⁾ 13.2	-V ¹⁾ 2.4 ; -V ¹⁾ 17.6	-V ¹⁾ 3.0 ; -V ¹⁾ 22	-V ¹⁾ 3.6 ; -V ¹⁾ 26.4	
Dimension(H x W x D)	457.8 x 480 x 593 mm	457.8 x 480 x 593 mm	635.7 x 480 x 593 mm	813.5 x 480 x 593 mm	1283 x 600 x 600 mm	1283 x 600 x 600 mm	
Weight	58 kg	70 kg	105 kg	140 kg	202 kg	295 kg	

¹⁾ 1 ms (millisiemens) is the unit of conductance[G], one siemens equal to 1/Ω

²⁾ Operating temperature range is 0-40°C, all specification apply for 25°C±5°C, Except as noted

³⁾ Turbo mode for up to 2X Current rating & Power rating support Fuse, Short/OCF/OPP test function

⁴⁾ The specification apply for current less than 20Arms

* All specifications apply for 50/60Hz

* All specifications subject to change without notice

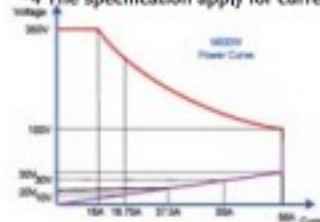

AEL-5006-350-56

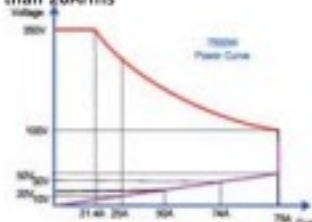

AEL-5008-350-75

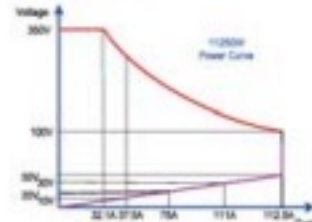

AEL-5012-350-112.5

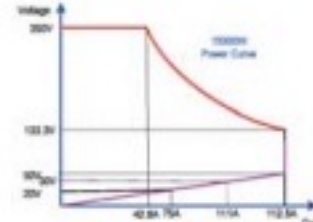

AEL-5015-350-112.5

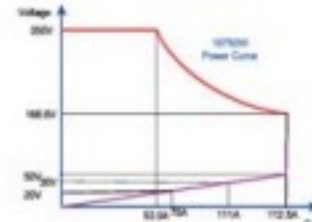

AEL-5019-350-112.5

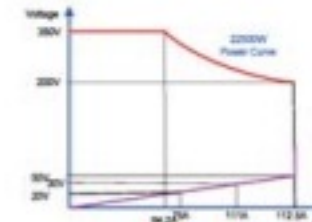

AEL-5023-350-112.5

AC & DC Electronic Load

SPECIFICATIONS

MODEL	AEL-5006-425-56	AEL-5008-425-75	AEL-5012-425-112.5	AEL-5015-425-112.5	AEL-5019-425-112.5	AEL-5023-425-112.5
Power (W)	5600W	7500W	11250W	15000W	18750W	22500W
Current(Ampere)	56 Arms / 168Apeak	75 Arms / 225Apeak	112.5 Arms / 337.5Apeak	112.5 Arms / 337.5Apeak	112.5 Arms / 337.5Apeak	112.5 Arms / 337.5Apeak
Voltage(Volt)	50-425Vrms / 600Vdc					
FREQUENCY Range	DC, 40-440Hz(CC,CP Mode) , DC, 40-440Hz(LIN,CH,CV Mode)					
PROTECTIONS						
Over Power Protection	≠ 5880Wrms or Programmable	≠ 7875Wrms or Programmable	≠ 11812.5Wrms or Programmable	≠ 15750Wrms or Programmable	≠ 19687.5Wrms or Programmable	≠ 23625Wrms or Programmable
Over Current Protection	≠ 58.8 Arms, or Programmable	≠ 78.75 Arms, or Programmable	≠ 118.125 Arms, or Programmable	≠ 118.125 Arms, or Programmable	≠ 118.125 Arms, or Programmable	≠ 118.125 Arms, or Programmable
Over Voltage Protection	≠ 446.25 Vrms/630Vdc					
Over Temp. Protection	Yes					
OPERATION MODE						
Constant Current Mode for Sine-Wave						
Range	0-56A	0-75A	0-112.5A	0-112.5A	0-112.5A	0-112.5A
Resolution	1mA/16bits	1.25mA/16bits	1.875mA/16bits	1.875mA/16bits	1.875mA/16bits	1.875mA/16bits
Accuracy	± 0.1% of setting + 0.2% of range @ 50/60Hz , ± 0.5% of setting + range @ DC and 400Hz					
Linear Constant Current Mode for Sine-Wave, Square-Wave or Quasi-Square Wave, PWM Wave						
Range	0-56A	0-75A	0-112.5A	0-112.5A	0-112.5A	0-112.5A
Resolution	1mA/16bits	1.25mA/16bits	1.875mA/16bits	1.875mA/16bits	1.875mA/16bits	1.875mA/16bits
Accuracy	± 0.1% of setting + 0.2% of range @ 50/60Hz , ± 0.5% of setting + range @ DC and 400Hz					
Constant Resistance Mode						
Range	1 ohm - 20k ohm	0.8 ohm - 16k ohm	0.533 ohm - 10.66k ohm	0.533 ohm - 10.66k ohm	0.533 ohm - 10.66k ohm	0.533 ohm - 10.66k ohm
Resolution*1	0.01666mS/16bits	0.020832mS/16bits	0.031248mS/16bits	0.031248mS/16bits	0.031248mS/16bits	0.031248mS/16bits
Accuracy	± 0.2% of setting + range @ 50/60Hz , ± 0.5% of setting + range @ DC and 400Hz					
Constant Voltage Mode						
Range	50-425Vrms / 600Vdc					
Resolution	0.1V					
Accuracy	± 0.2% of setting + range @ 50/60Hz					
Constant Power Mode						
Range	5600W	7500W	11250W	15000W	18750W	22500W
Resolution	0.1W	0.1W	1W	1W	1W	1W
Accuracy*4	± 0.5% of setting + range @ 50/60Hz , ± 2% of setting + range					
CREST FACTOR (CC & CP MODE ONLY)						
Range	0-1 Lag or Lead					
Resolution	0.01					
Accuracy	1% F.S.					
POWER FACTOR (CC & CP MODE ONLY)						
Range	0-1 Lag or Lead					
Resolution	0.01					
Accuracy	1% F.S.					
TEST MODE						
UPS Efficiency Measurement	Non-Linear Mode					
Operating Frequency	Auto ; 40-440Hz					
Current Range	0-56A	0-75A	0-112.5A	0-112.5A	0-112.5A	0-112.5A
PF Range	0-1					
Measuring Efficiency For PV Systems, Power Conditioners for THD 50%	Resistive + Non-Linear Mode					
Operating Frequency	Auto ; 40-440Hz					
Current Range	0-56A	0-75A	0-112.5A	0-112.5A	0-112.5A	0-112.5A
Resistive Range	1 ohm - 20k ohm	0.8 ohm - 16k ohm	0.533 ohm - 10.66k ohm	0.533 ohm - 10.66k ohm	0.533 ohm - 10.66k ohm	0.533 ohm - 10.66k ohm
UPS Back-Up Function(CC, LIN, CH, CV)						
UVP (VTH)	50-425Vrms / 600Vdc					
UPS Back-Up Time	1-99999 Sec. (>27H)					
Battery Discharge Function(CC, LIN, CH, CV)						
UVP (VTH)	50-425Vrms / 600Vdc					
Battery Discharge Time	1-99999 Sec. (>27H)					
UPS Transfer Time						
Current Range	0-56A	0-75A	0-112.5A	0-112.5A	0-112.5A	0-112.5A
UVP (VTH)	2.5V					
Time range	0.15ms-999.99ms					
Fuse Test Mode						
Max. Current	Turbo OFF(CC1-3) Turbo ON(CC3) Turbo ON(CC1-2)	56Arms 112Arms (x2) ^{*1}	75Arms 150Arms (x2) ^{*1}	112.5Arms 225Arms (x2) ^{*3}	112.5Arms 225Arms (x2) ^{*3}	112.5Arms 225Arms (x2) ^{*3}
Trip & Non-Trip Time	Turbo OFF(Time1-3) Turbo ON(Time1-2) Turbo ON(Time3)	0.01-333.33 Sec. 0.01-0.50 Sec. 0.01-600.00 Sec.				0.01-333.33 Sec. 0.01-0.50 Sec. 0.01-600.00 Sec.
OFF Time	0.1-999.9 Sec.					
Meas. Accuracy	± 0.003 Sec.					
Repeat Cycle	0-99999					
Short/OPP/OCF Test Function						
Short Time	Turbo OFF Turbo ON	0.1-10Sec. or Cont. 0.1-1Sec.				0.1-10Sec. or Cont. 0.1-1Sec.
OPP/OCF Step Time	Turbo OFF Turbo ON	100ms 100ms, up to 10 Steps				100ms 100ms, up to 10 Steps
OCF Istop	Turbo OFF Turbo ON	56Arms 112Arms	75Arms 150Arms	112.5Arms 225Arms	112.5Arms 225Arms	112.5Arms 225Arms
OPP Pstop	Turbo OFF Turbo ON	5600W 11200W	7500W 15000W	11250W 22500W	15000W 30000W	18750W 37500W
Programmable Inrush Current Simulation: Inrush - Istop / Timp						
Inrush Start Current	0-112A	0-150A	0-225A	0-225A	0-225A	0-225A
Inrush Stop Time	0.1ms-100ms					
Inrush Stop Current	0-56A	0-75A	0-112.5A	0-112.5A	0-112.5A	0-112.5A
Programmable Surge Current Simulation: S1/T1 - S2/T2 - S3/T3						
S1 and S2 Current	0-112A	0-150A	0-225A	0-225A	0-225A	0-225A
T1 and T2 Time	0.01-0.55Sec.					
S3 Current	0-56A	0-75A	0-112.5A	0-112.5A	0-112.5A	0-112.5A
T3 Time	0.01-9.99Sec. or Cont.					
MEASUREMENTS						
VOLTAGE READBACK V METER						
Range	600V					
Resolution	0.01V					
Accuracy	± 0.05% of (reading + range)					
Parameter	Vrms, V Max/Min, +Vpk					
CURRENT READBACK A METER						
Range	28Arms/56Arms	37.5Arms/75Arms	56.25Arms/112.5Arms	56.25Arms/112.5Arms	56.25Arms/112.5Arms	56.25Arms/112.5Arms
Resolution	0.6mA/1.2mA	0.8mA/1.6mA	1.2mA/2.4mA	1.2mA/2.4mA	1.2mA/2.4mA	1.2mA/2.4mA
Accuracy	± 0.1% of reading + range @ 50/60Hz					
Parameter	Irms, I Max/Min, +Ipk					
WATT READBACK W METER						
Range	5600W	7500W	11250W	15000W	18750W	22500W
Resolution	0.1W	0.125W	0.1875W	0.25W	0.3125W	0.375W
Accuracy*4	± 0.5% of reading + range @ 50/60Hz , ± 5% of reading + range					
VA METER	Vrms x Arms Correspond To Vrms and Arms					
Power Factor METER						
Range	+/- 0.000-1.000					
Accuracy	± 0.002 ± (0.001/ PF) * PF					
Frequency METER(Hz)						
Range	DC, 40-440Hz					
Accuracy	0.1%					
Other Parameter METER	VA, VAR, CF, I, Ipeak, Imax, Imin, Vmax, Vmin, IHD, VHD, ITHD, VTHD					
OTHERS						
Start up Loading	Yes, Power on loading during Inverter / UPS start up					
Load ON / OFF Angle	0 - 359 degree can be programmed for the angle of load ON and load OFF loading					
Half Cycle and SCR/TRIAC Loading	Positive or Negative half cycle, 90° Trailing edge or Leading edge current waveform can be programmed					
Master/Slave (3 Phase or Parallel Application)	Yes, 1 master and upto 7 slave unit					
External Programming Input (OPTION)	F.S / 10Vdc, Resolution 0.1V					
External SYNC Input	TTL					
Vmonitor (Isolated)	+600V / ±10V					
Imonitor (Isolated)	± 168Apk / ± 10Vpk	± 225Apk / ± 10Vpk	± 337.5Apk / ± 10Vpk	± 337.5Apk / ± 10Vpk	± 337.5Apk / ± 10Vpk	± 337.5Apk / ± 10Vpk
Interface (OPTION)	GPIO ; RS-232 ; LAN ; USB					
MAX. Power Consumption	270VA	270VA	390VA	510VA	630VA	750VA
Operation Temperature *2	0 - 40 °C					
Current of Input Impedance(mA)@50/60Hz ; @ 400Hz	-V*0.9 ; -V*6.6	-V*1.2 ; -V*8.8	-V*1.8 ; -V*13.2	-V*2.4 ; -V*17.6	-V*3.0 ; -V*22	-V*3.6 ; -V*26.4
Dimension H x W x D	457.8 x 480 x 593 mm	457.8 x 480 x 593 mm	635.7 x 480 x 593 mm	813.5 x 480 x 593 mm	1283 x 600 x 600 mm	1283 x 600 x 600 mm
Weight	58 kg	70 kg	105 kg	140 kg	260 kg	295 kg

*1 ms (millisemens) is the unit of conductance(G), one siemens equal to 1/Ω

*2 Operating temperature range is 0-40°C, all specification apply for 25°C±5°C, Except as noted

*3 Turbo mode for up to 2X Current rating & Power rating support Fuse, Short/OCF/OPP test function

*4 The specification apply for current less than 20Arms

* AI specifications apply for 50/60Hz

* AI specifications subject to change without notice

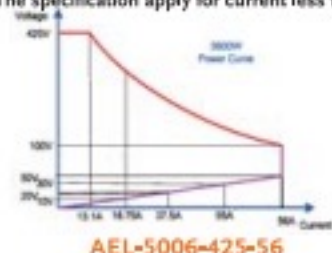

AEL-5006-425-56

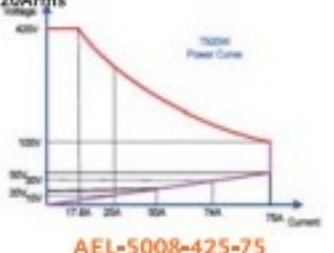

AEL-5008-425-75

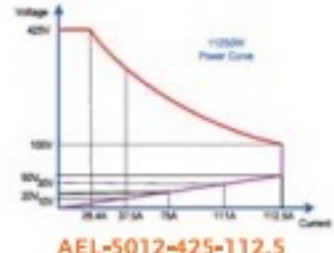

AEL-5012-425-112.5

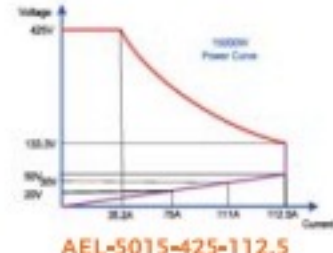

AEL-5015-425-112.5

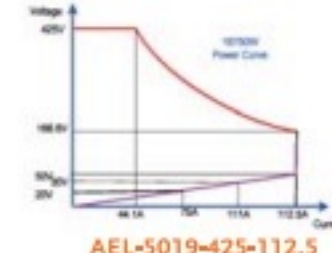

AEL-5019-425-112.5

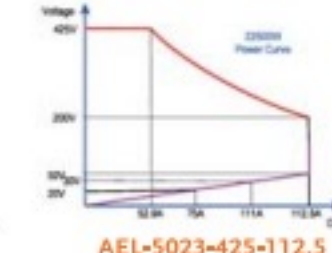

AEL-5023-425-112.5

SPECIFICATIONS

MODEL	AEL-5003-480-18.75	AEL-5004-480-28
Power (W)	2800W	3750W
Current(Ampere)	18.75 Arms / 36.25Apeak	28 Arms / 84Apeak
Voltage(Volt)	50-480Vrms / 700Vdc	
FREQUENCY Range	DC, 40-70Hz(CC,CP Mode) ; DC-70Hz(LIN,CR,CV Mode)	
PROTECTIONS		
Over Power Protection	≈2940Wrms or Programmable	≈3937.5Wrms or Programmable
Over Current Protection	≈ 19.687 Arms or Programmable	≈ 29.4 Arms or Programmable
Over Voltage Protection	≈ 504Vrms / 735Vdc	
Over Temp. Protection	Yes	
OPERATION MODE		
Constant Current Mode for Sine-Wave		
Range	0-18.75A	0-28A
Resolution	0.3125mA/16bits	0.5mA/16bits
Accuracy	± 0.1% of setting + 0.2% of range @ 50/60Hz ; ± 0.5% of setting + range @ DC and 400Hz	
Linear Constant Current Mode for Sine-Wave, Square-Wave or Quasi-Square Wave, PWM Wave		
Range	0-18.75A	0-28A
Resolution	0.3125mA/16bits	0.5mA/16bits
Accuracy	± 0.1% of setting + 0.2% of range @ 50/60Hz ; ± 0.5% of setting + range + range @ DC and 400Hz	
Constant Resistance Mode		
Range	4 ohm - 80k ohm	2.5 ohm - 50k ohm
Resolution*1	0.004166mΩ/16bits	0.006666mΩ/16bits
Accuracy	±0.2% of setting + range @ 50/60Hz ; ± 0.5% of setting + range + range @ DC and 400Hz	
Constant Voltage Mode		
Range	50-480Vrms / 700Vdc	
Resolution	0.0125V	
Accuracy	±0.1% of setting + 0.1% of range	
Constant Power Mode		
Range	2800W	3750W
Resolution	0.1W	0.1W
Accuracy*4	±0.5% of (setting + range) @ 50/60Hz ; ±2% of (setting + range)	
CREST FACTOR (CC & CP MODE ONLY)		
Range	-2-5	
Resolution	0.1	
Accuracy	(0.5% / 1rms) + 1% F.S.	
POWER FACTOR (CC & CP MODE ONLY)		
Range	0-1 Lag or Lead	
Resolution	0.01	
Accuracy	1% F.S.	
TEST MODE		
UPS Efficiency Measurement		
Operating Frequency	Non-Linear Mode	
Current Range	0-18.75A	0-28A
PF Range	0-1	
Measuring Efficiency For PV Systems, Power Conditioners for THD 80%		
Operating Frequency	Auto ; 40-70Hz	
Current Range	0-18.75A	0-28A
Resistive Range	4 ohm - 80k ohm	2.5 ohm - 50k ohm
UPS Back-Up Function(CC,UN,OL,CP)		
LVP (VTH)	50-480Vrms / 700Vdc	
UPS Back-Up Time	1-99999 Sec. (>27H)	
Battery Discharge Function(CC,UN,OL,CP)		
LVP (VTH)	50-480Vrms / 700Vdc	
Battery Discharge Time	1-99999 Sec. (>27H)	
UPS Transfer Time		
Current Range	0-18.75A	0-28A
LVP (VTH)	2.5V	
Time range	0.15ms-999.99ms	
Fuse Test Mode		
Max. Current	Turbo OFF(CC1-3) Turbo ON(CC3) Turbo ON(CC1-2)	18.75Arms 37.5Arms (x2) *3 37.5Arms (x2) *3
Trip & Non-Trip Time	Turbo OFF(Time1-3) Turbo ON(Time1-2) Turbo ON(Time3)	0.01-333.33 Sec. 0.01-0.50 Sec. 0.01-600.00 Sec.
OFF Time		0.1-999.9 Sec.
Meas. Accuracy		±0.003 Sec.
Repeat Cycle		0-99999
Short/OPP/OCP Test Function		
Short Time	Turbo OFF Turbo ON	100ms
OPP/OCP Step Time	Turbo OFF Turbo ON	100ms, up to 10 Steps
OCP Isop	Turbo OFF Turbo ON	18.75Arms 37.5Arms
OPP Pstop	Turbo OFF Turbo ON	2800W 5600W
Programmable Inrush Current Simulation: Inrush - Instop / Yeop		
Inrush Start Current	0-37.5k	0-56A k
Inrush Stop Time		0.1ms-100ms
Instop, Inrush Stop Current	0-18.75A	0-28A
Programmable Surge Current Simulation: S1/T1 - S2/T2 - S3/T3		
S1 and S2 Current	0-37.5A	0-56A
T1 and T2 Time		0.01-0.5Sec.
S3 Current	0-18.75A	0-28A
T3 Time		0.01-9.99Sec. or Cont.
MEASUREMENTS		
VOLTAGE READBACK V METER		
Range	700V	
Resolution	0.0125V	
Accuracy	±0.05% of (reading + range)	
Parameter	Vrms, V Max/Min, +/-Vpk	
CURRENT READBACK A METER		
Range	9.375Arms/18.75Arms	14Arms/28Arms
Resolution	0.2mA/0.4mA	0.3mA/0.6mA
Accuracy	±0.05% of (reading + range) @ 50/60Hz	
Parameter	Imax, I Max/Min, +/-Ipk	
WATT READBACK W METER		
Range	2800W	3750W
Resolution	0.05W	0.0625W
Accuracy*4	±0.5% of (reading + range) @ 50/60Hz ; ±2% of (reading + range)	
VA METER	VrmsxArms Correspond To Vrms and Arms	
Power Factor METER		
Range	±0.000-1.000	
Accuracy	±(0.002+(0.001/(PF)*F)	
Frequency METER(Hz)		
Range	DC, 40-70Hz	
Accuracy	0.1%	
Other Parameter METER		
	VA, VAR, CF, I, Ipeak, Imax., Imin., Vmax., Vmin., IPHD, VHD, ITHD, VTHD	
OTHERS		
Start up Loading	Yes, Power on loading during inverter / UPS start up	
Load ON / OFF Angle	0 - 359 degree can be programmed for the angle of load ON and load OFF loading	
Half Cycle and SCR/TRIAC Loading	Positive or Negative half cycle, 90° Trailing edge or Leading edge current waveform can be programmed	
Master/Slave (3 Phase or Parallel Application)	Yes, 1 master and upto 7 slave units	
External Programming Input (OPTION)	F.S / 10Vdc, Resolution 0.1V	
External SYNC Input	TTL	
Vmonitor (Isolated)	±700V / ±10V	
Imonitor (Isolated)	±56.25Apk / ±10Vpk	
Interface (OPTION)	GPIB ; RS-232 ; LAN ; USB	
MAX. Power Consumption	150VA	
Operation Temperature °C	0 - 40 °C	
Current of Input Impedance(mA)@50/60Hz ; @ 400Hz	-V*0.1 ; -V*2.2	-V*0.4 ; -V*2.95
Dimension(H x W x D)	177 x 440 x 552.6 mm	177 x 440 x 552.6 mm
Weight	27.5kg	33.5kg

*1 ms (milliSiemens) is the unit of conductance(G), one siemens equal to 1/Ω

*2 Operating temperature range is 0-40°C, all specification apply for 25°C±5°C, Except as noted

*3 Turbo mode for up to 2X Current rating & Power rating support Fuse, Short/OCP/OPP test function

*4 The specification apply for current less than 20Arms

* All specifications apply for 50/60Hz

* All specifications subject to change without notice

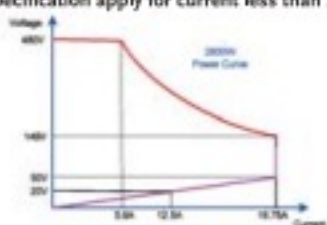

AEL-5003-480-18.75

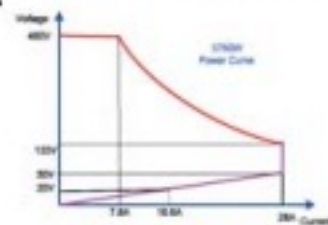

AEL-5004-480-28

PEL-022 GPIB Card



PEL-023 RS-232 Card

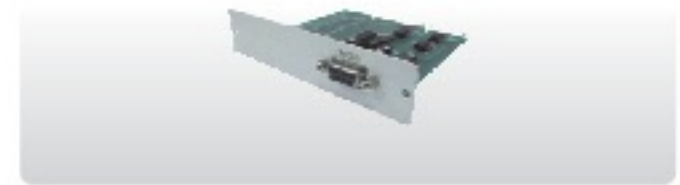

PEL-024 LAN Card



PEL-025 USB Card



PEL-028 HANDLES, U-shaped handle
(for AEL-5006/5008/5012/5015)



PEL-029 HANDLES Rack Accessories
(for AEL-5002/5003/5004)



High Power DC Electronic Load



PEL-5000G Series

NEW



FEATURES

- * 4U/6K High Power Density Design Also for Bench Testing
- * Turbo Mode Function, Which Allows 1.5 Times the Rated Power or Current to be Used Within Two Seconds
- * Turbo Mode can be Used with OCP/OPP/ BMS/Short Mode/Surge Mode/Hot Plug-In Testing
- * High Tolerance to Environmental Temperature, with 4k/5kW Models not Affected by Environmental Temperature in Power Usage
- * Can set the Power-on Status Value
- * Short Circuit Duration Can be set Within Short Circuit Test Voltage Meter Display Can be Configured as Polarity Positive ("+") or Negative ("-")
- * Optional Interface : GPIB, RS232, USB, LAN
- * Protection function Testing for Battery BMS
- * Protection Against V, I, W, and °C

GW Instek PEL-5000G series single-channel electronic load provides 150V/ 600V/ 1200V models with a power range of 4, 5, 6kW. PEL-5000G can test and verify the specifications of batteries, electric vehicle chargers/charging stations, electric vehicle batteries and solar panels. PEL-5000G supports parallel connection for same voltage specification and different power models. PEL-5000G can support up to 8 units connected in parallel.

PEL-5000G Series has its own control and display panel, CC / CR / CV / CP /Dynamic modes. The new Turbo mode is designed for overload or protection testing, which includes OCP, OPP, Short for AC/DC or DC/DC power source; Over Charge/Discharge and Short for Battery BMS protection; and Blow/Not Blow testing for Fuse, Breaker or PTC Current Protection Components.

Support Short, OCCP and OCPD protection tests for battery BMS protection testing, the peak current before protection and protection response time are measured. The BMS, Fuse, OCP and OPP single-key test functions on the module make test more efficient. The SHORT duration setting and SHORT_VH, SHORT_VL setting function, also can measure Short Voltage and Current. PEL-5000G also provides Programmable LOAD ON/OFF voltage, GO/NG meter check, Voltage meter display " + " or " - " is selectable

Dynamic can be simulated under CC, CP mode. The current Rise / Fall slew rate can be adjusted individually and there is an external signal input so that load can have a simulated Specific Load Current Waveform. PEL-5000G also provides 150 sets Store / Recall larger memory is much advance feature for each different application. The 150 sets test parameter and status storage function can call the storage memory real time in accordance with the auto sequence requirement, at any time to tune out the stored memory for use.

The communication interfaces supported by PEL-5000G include GPIB, RS232, USB, and LAN. The power, voltage and current of each model are shown in the following table:

PEL-022 GPIB Card



PEL-023 RS-232 Card



PEL-024 LAN Card



PEL-025 USB Card



PEL-028 Handles



PEL-031 Rack Mount Kit



PEL-032 9923 Current Waveform Generator + RS232 Interface



ORDERING INFORMATION

PEL-5004G-150-400	150V/400A/4000W High Power DC Electronic Load
PEL-5005G-150-500	150V/500A/5000W High Power DC Electronic Load
PEL-5006G-150-600	150V/600A/6000W High Power DC Electronic Load
PEL-5004G-600-280	600V/280A/4000W High Power DC Electronic Load
PEL-5005G-600-350	600V/350A/5000W High Power DC Electronic Load
PEL-5006G-600-420	600V/420A/6000W High Power DC Electronic Load
PEL-5004G-1200-160	1200V/160A/4000W High Power DC Electronic Load
PEL-5005G-1200-200	1200V/200A/5000W High Power DC Electronic Load
PEL-5006G-1200-240	1200V/240A/6000W High Power DC Electronic Load

PEL-5006G-1200-240

Power rating: 6 → 6A kW
 Maximum output current: 240 → 240A
 Maximum output voltage: 1200 → 1200V

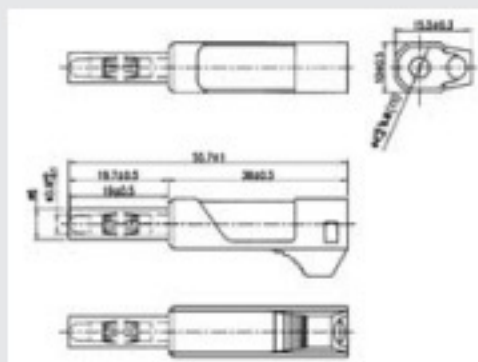

STANDARD ACCESSORIES

- PEL-5000G Series operation manual
- BANANA PLUGS : Please refer to Fig.1 x 1
- BNC – BNC CABLE : BNC to BNC CABLE, 1m x 1
- HD-DSUB : 15PIN Parallel wire Parallel Wire x 1
- PEL-028 HANDLES, U-shaped handle(fixed to the bracket)
- PEL-031 Rack Mount Kit For PEL-5000G

OPTIONAL ACCESSORIES

PEL-022	GPIB Card	GTL-246	USB Cable, USB 2.0, A-B Type, 1200mm
PEL-023	RS-232 Card	GTL-248	GPIB Cable, Double Shielded, 2000mm
PEL-024	LAN Card	GTL-250	GPIB Cable, Double Shielded, 600mm
PEL-025	USB Card	PEL-032	9923 Current Waveform Generator + RS232 Interface
PEL-030	GPIB+RS-232 Card		

Note: * Regarding the product delivery date, please contact your regional sales representative.

Rear Panel



ACCESSORIES

MODEL	DESCRIPTION	APPLICABLE DEVICE
APS-001	GPIB Interface Card	APS-7000 Series
APS-002	RS-232/USB Interface Card	APS-7050, APS-7100
APS-003	Output Voltage Capacity (0-600Vrms)	APS-7000 Series
APS-004	Output Frequency Capacity (45-999.9Hz)	APS-7000 Series
APS-007	RS-232 Interface Card	APS-7200, APS-7300
APS-008	Air Inlet Filter	ASR-3000 Series
ASR-001	Air Inlet Filter	ASR-2000 Series
ASR-002	External Three Phase Control Unit	ASR-2000 Series, ASR-3000 Series
GET-001	Extended Terminal with max.30A for 30V/80V/160V models	PSW-Series, PSW-Multi Series
GET-002	Extended Terminal with max.10A for 250V/800V models	PSW-Series, PSW-Multi Series
GET-003	Extended Universal Power Socket	ASR-2000 Series
GET-004	Extended European Power Socket	ASR-2000 Series
GET-005	Extended European Terminal with max.20A for 30V/80V/160V models	PSW-Series, PSW-Multi Series
GPS-001	Knob, Voltage/Current Protection Knob	GPS-x303 Series, SPD-3606
GPW-001	UL/CSA Power Cord, 3000mm	PSU-Series
GPW-002	VDE Power Cord, 3000mm	PSU-Series
GPW-003	PSE Power Cord, 3000mm	PSU-Series
GPW-005	Power cord, 3m, 105°C, UL/CSA type	ASR-3000 Series
GPW-006	Power cord, 3m, 105°C, VDE type	ASR-3000 Series
GPW-007	Power cord, 3m, 105°C, PSE type	ASR-3000 Series
GRA-401	Rack Mount Kit, 19", 4U Size	GPC-Series, GPR-M Series, PPE-3323, PPS-3635, PPT-Series, PEL-300
GRA-403	Rack Mount Kit, 19", 4U Size	PSH-Series
GRA-407	Rack Mount Kit, 19", 4U Size	PSM-Series
GRA-408	Rack Mount Kit, 19", 4U Size	PSS-Series
GRA-409	Rack Mount Kit, 19", 5U Size	APS-1102A
GRA-410-E	Rack Mount Kit (EIA), 19", 3U Size	PSW-Series, PSW-Multi Series
GRA-410-J	Rack Mount Kitt (JIS), 19", 3U Size	PSW-Series, PSW-Multi Series
GRA-413-E	Rack Mount Kitt (EIA), 19", 3U Size	PEL-3211/3211H
GRA-413-J	Rack Mount Kitt (JIS), 19", 3U Size	PEL-3211/3211H
GRA-414-E	Rack Mount Kit (EIA), 19", 3U Size	PEL-3021(H)/3041(H)/3111(H), PEL-3000E Series
GRA-414-J	Rack Mount Kit (JIS), 19", 3U Size	PEL-3021(H)/3041(H)/3111(H), PEL-3000E Series
GRA-418-E	Rack Mount Kit (EIA), 19", 3U Size	PSB-1000 Series
GRA-418-J	Rack Mount Kit (JIS), 19", 3U Size	PSB-1000 Series
GRA-419-E	Rack Mount Kit (EIA), 19", 2U Size	PCS-1000I
GRA-419-J	Rack Mount Kit (JIS), 19", 2U Size	PCS-1000I
GRA-423	Rack Mount Kit, 19", 2U Size	APS-7000/7000E Series
GRA-424	Rack Mount Kit, 19", 3U Size	PSB-2000 Series
GRA-428	Rack Mount Kit (EIA), 19", 3U Size	PSP-Series
GRA-429	Rack Mount Kit, 7U Size	APS-7200 Series
GRA-430	Rack Mount Kit, 9U Size	APS-7300 Series
GRA-431-J	Rack Mount Kit (JIS)	PFR-Series
GRA-431-E	Rack Mount Kit (EIA)	PFR-Series
GRA-439-J	Rack Mount Kit (JIS), 19", 3U Size	ASR-2000 Series
GRA-439-E	Rack Mount Kit(EIA), 19", 3U Size	ASR-2000 Series
GRA-441-J	Rack Mount Kit (JIS), 19", 3U Size	PPX-Series
GRA-441-E	Rack Mount Kit(EIA), 19", 3U Size	PPX-Series
GRA-442-J	Rack Mount Kit (JIS), 19", 3U Size	ASR-3000 Series
GRA-442-E	Rack Mount Kit(EIA), 19", 3U Size	ASR-3000 Series
GRA-449-J	Rack Mount Kit (JIS), 19", 3U Size	GPP-Series, GPP-3060/6030
GRA-449-E	Rack Mount Kit (EIA), 19", 3U Size	GPP-Series, GPP-3060/6030
GRJ-1101	Module Cable (0.5m)	PSB-2000 Series
GRM-001	Slide Bracket 2pcs/set	PSU-Series
GTL-104A	Test Lead, U-type to Alligator Test Lead, Max. Current 10A, 1000mm	PFR/PSM/PSP/PST/GPC/GPD/GPP/GPR/GPS/GPE/PPT-Series, PPS-3635, SPD-3606, PPX-Series, GPP-3060/6030
GTL-105A	Test Lead, Alligator to Banana Test Lead, Max. Current 3A, 1000mm	PFR/PSS/PST/GPC/GPD/GPP/GPR/GPS/PPT-Series, PEL-2000B, PPE-3323, SPD-3606, PCS-1000I, PPX-Series
GTL-117	Test Lead, Banana to Probe Test Lead, 1200mm	PPH-1503/1503D/1506D
GTL-120	Test Lead, O-type to O-type Test Lead, Max. 40A, 1200mm	PEL-3000/3000H Series, PEL-2000A(B) Series
GTL-121	Sense Lead, O-type to free Lead, 1200mm	PEL-2000A(B) Series
GTL-122	Test Lead, U-type to Alligator Test Lead, Max. Current 40A, 1200mm	PSH-Series, GPR-U Series, GPR-H Series
GTL-123	Test Lead, O-type to O-type Test Lead, 1200mm	PSW-Series, APS-7000 Series, PSB-1000 Series
GTL-130	Test Leads: 2 x red, 2 x black, for 250V/800V models, 1200mm	PSW-Series, PSW-Multi Series
GTL-134	Test Leads for Rear Panel, 1200mm, 10A, 16 AWG	PFR-Series
GTL-137	Output Power wire(load wire...10AWG:50A, 600V/sense wire...16AWG:20A, 600V)	ASR-3000 Series
GTL-201A	Ground Lead, Banana to Banana, European Terminal, 200mm	AFG-200/100 Series, PSM Series, GPD-Series, GPP-Series, GPS-X303 Series, SPD-3606, PPX-Series, GPP-3060/6030
GTL-202	Sense Lead, Banana to Banana Lead, European Terminal, 200mm	PSM-Series
GTL-203A	Test Lead, Banana to Alligator, European Terminal, Max. Current 3A, 1000mm	PSS/PST/GPD/GPP/GPS/GPE/PPT/PST/GPD/GPP-Series, SPD-3606, PPH-1503/1503D/1506D, PPX-Series
GTL-204A	Test Lead, Banana to Alligator, European Terminal, Max. Current 10A, 1000mm	PFR/PSM/PSP/PSS/GPS/GPE/PPT/PST/GPD/GPP-Series, SPD-3606, PPH-1503/1503D/1506D, PPX-Series, GPP-3060/6030
GTL-205A	Temperature Probe Adapter(Thermal Coupling, K-Type), about 1000mm	PPX-Series
GTL-207A	Test Lead, Banana to Probe Test Lead, 800mm	PCS-1000I, GSM-20H10
GTL-218	Test Lead, O-type to O-type Test Lead, Max. 200A, 1500mm	PSU/PSW/PEL-3000 Series
GTL-219	Test Lead, O-type to O-type Test Lead, Max. 200A, 3000mm	PSU/PSW/PEL-3000 Series
GTL-220	Test Lead, O-type to O-type Test Lead, Max. 300A, 1500mm	PSU/PSW/PEL-3000 Series
GTL-221	Test Lead, O-type to O-type Test Lead, Max. 300A, 3000mm	PSU/PSW/PEL-3000 Series
GTL-222	Test Lead, O-type to O-type Test Lead, Max. 400A, 1500mm	PSU/PSW/PEL-3000 Series
GTL-223	Test Lead, O-type to O-type Test Lead, Max. 400A, 3000mm	PSU/PSW/PEL-3000 Series
GTL-232	RS-232C Cable, 9-pin, F-F Type, null modem, 2000mm	PSH/PSM/PSS-Series, APS-7000 Series, PEL-2000A(B) Series, ASR-2000 Series, ASR-3000 Series
GTL-232A	RS-232C Cable, 9-pin, F-F Type, null modem, 2000mm	PSP-Series
GTL-234	RS-232C Cable, 9-pin, F-F Type, 2000mm	APS-1102A
GTL-238	RS-232 Cable, 9-pin, M-F Type, 1000mm	PEL-500 Series
GTL-240	USB Cable, USB 2.0, A-B Type (L Type), 1200mm	PSW-Series, PSU-Series, APS-1102A, APS-7000 Series, PCS-1000I
GTL-246	USB Cable, USB 2.0, A-B Type, 1200mm	PFR-Series, PSU-Series, PSB-2000 Series, PPH-1503/1503D, GPD-Series, GPP-Series, APS-1102A, APS-7000 Series, PEL-3000/3000H Series, PEL-3000E, PEL-2000A(B) Series, PPX-Series, ASR-3000 Series, PEL-5000C Series, AEL-5000 Series, GPP-3060/6030, GSM-20H10, PEL-5000G

















ACCESSORIES

MODEL	DESCRIPTION	APPLICABLE DEVICE
GTL-248	GPIB Cable, Double Shielded, 2000mm	PSB-2000 Series, PPH-1503, PSW/PSW-Multi/PSU/PSH/PSM/PSS/PPT-Series, APS-7000 Series, PEL-3000/3000H Series, PEL-3000E Series, PEL-2000A(B) Series, ASR-3000 Series, PEL-5000C Series, AEL-5000 Series, PEL-5000G Series, GSM-20H10
GTL-249	Frame Link Cable, 300mm	PEL-2000A(B) Series
GTL-250	GPIB Cable, Double Shielded, 600mm	PSW/PSW-Multi/PSU/PSH-Series, PSB-2000 Series, APS-7000 Series, PEL-5000C Series, AEL-5000 Series
GTL-255	Frame Link Cable, 300mm	PEL-3000/3000H Series
GTL-258	GPIB Cable, 25 pins Micro-D Connector	PFR-Series, PPX-Series, ASR-2000 Series, PSU-Series
GTL-259	RS-232 Cable with DB9 Connector to RJ45	PPX-Series, PFR-Series, PSU-Series
GTL-260	RS-485 Cable with DB9 Connector to RJ45	PPX-Series, PFR-Series, PSU-Series
GTL-261	Serial Master Cable + Terminator, 0.5M	PSU-Series, PFR-Series, PSU-Series, PPX-Series
GTL-262	RS-485 Slave Cable	PPX-Series, PFR-Series, PSU-Series
GUG-001	GPIB-USB Adaptor, GPIB to USB Adaptor	GDS-3000 Series, PSW-Series, PSW-Multi Series
GUR-001A	RS232-USB Cable, 300mm	PSW-Series, PSW-Multi Series
GUR-001B	RS-232 to USB Adapter with #4-40 UNC Rivet Nut	PSW-Multi Series
PCS-001	Basic Accessory Kit	PCS-1000I
PEL-001	GPIB Card	PEL-2000A(B) Series
PEL-002	Rack Mount Kit, PEL-2000 Series Rack Mount Kit	PEL-2000A(B) Series
PEL-003	Panel Cover	PEL-2000A(B) Series
PEL-004	GPIB Card	PEL-3000/3000H Series, PEL-3000E Series
PEL-005	Connect Cu Plate	PEL-3000/3000H Series
PEL-006	Connect Cu Plate	PEL-3000/3000H Series
PEL-007	Connect Cu Plate	PEL-3000/3000H Series
PEL-008	Connect Cu Plate	PEL-3000/3000H Series
PEL-009	Connect Cu Plate	PEL-3000/3000H Series
PEL-010	Dust Filter	PEL-3000/3000H Series, PEL-3000E Series
PEL-011	Load Input Terminal Cover	PEL-3000/3000H Series
PEL-012	Terminal Fittings Kits	PEL-3000/3000H Series
PEL-013	Flexible Terminal Cover	PEL-3000/3000H Series
PEL-014	J1/J2 Protection Plug	PEL-3000/3000H Series
PEL-016	LAN Card	PEL-2000A(B) Series
PEL-018	LAN Card	PEL-3000/3000H Series, PEL-3000E Series
PEL-022	GPIB Card	PEL-5000C Series, AEL-5000 Series, PEL-5000G Series
PEL-023	RS-232 Card	PEL-5000C Series, AEL-5000 Series, PEL-5000G Series
PEL-024	LAN Card	PEL-5000C Series, AEL-5000 Series, PEL-5000G Series
PEL-025	USB Card	PEL-5000C Series, AEL-5000 Series, PEL-5000G Series
PEL-026	Hook Ring	PEL-5000C Series
PEL-027-1-4	Rack Mount Kit	PEL-5000C Series
PEL-028	HANDLES, U-shaped Handle(Fixed to the Bracket)	PEL-5000C Series, AEL-5000 Series
PEL-029	HANDLES Rack Accessories (for AEL-5002/5003/5004)	AEL-5000 Series
PEL-030	GPIB+RS-232 Card	PEL-5000C Series, AEL-5000 Series, PEL-5000G Series
PEL-031	Rack Mount Kit	PEL-5000G
PEL-032	9923 Current Waveform Generator + RS232 Interface	PEL-5000G
PPX-G	GPIB Interface(Factory Installed)	PPX-Series
PSB-001	GPIB Card	PSB-2000 Series, PSB-1000 Series
PSB-003	Parallel Connection Kit (for Horizontal Installation), Kit Includes: (PSB-007 Joint Kit, Horizontal bus bar x 2, PSB-005 x1)	PSB-2000 Series, PSB-1000 Series
PSB-004	Parallel Connection Kit (for Vertical Installation) Kit Includes: (PSB-007 Joint Kit, Vertical bus bar x 2, PSB-005 x 1)	PSB-2000 Series, PSB-1000 Series
PSB-005	Parallel Connection Signal Cable	PSB-2000 Series, PSB-1000 Series
PSB-006	Serial Connection Signal Cable	PSB-2000 Series, PSB-1000 Series
PSB-007	Joint Kit: Includes 4 Joining Plates, [M3x6]screws x 4; [M3x8]screw x 2	PSB-2000 Series
PSB-008	RS232C Cable (PSB-2000 Only)	PSB-2000 Series
PSB-101	Cable for 2 units of PSB-1000 units in Parallel Mode Connection	PSB-1000 Series
PSB-102	Cable for 3 units of PSB-1000 units in Parallel Mode Connection	PSB-1000 Series
PSB-103	Cable for 4 units of PSB-1000 units in Parallel Mode Connection	PSB-1000 Series
PSB-104	Cable for 2 units of PSB-1000 units in Series Mode Connection	PSB-1000 Series
PSB-105	GPIB Card	PSB-1000 Series
PSB-106	Basic Accessory Kit : M4 Terminal Screws and Washers x 2, M8 Terminal Bolts, Nuts and Washers x 2, Analog Control Protection Dummy x 1, Analog Control Lock Level x 2, Short Bar x 1	PSB-1000 Series
PSU-001	Front Panel Filter kit(Factory Installed)	PSU-Series
PSU-01A	Joins a vertical stack of 2 PSU units together. 2U-sized handles x 2, joining plates x 2	PSU-Series
PSU-01B	Bus Bar for 2 units in parallel operation	PSU-Series
PSU-01C	Cable for 2 units in parallel operation	PSU-Series
PSU-02A	Joins a vertical stack of 3 PSU units Together. 3U-sized Handles x 2, joining plates x 2	PSU-Series
PSU-02B	Bus Bar for 3 units in Parallel Operation	PSU-Series
PSU-02C	Cable for 3 units in Parallel Operation	PSU-Series
PSU-03A	Joins a Vertical Stack of 4 PSU units Together. 4U-sized Handles x 2, joining plates x 2	PSU-Series
PSU-03B	Bus Bar for 4 units in Parallel Operation	PSU-Series
PSU-03C	Cable for 4 units in Parallel Operation	PSU-Series
PSU-232	RS232 Cable with DB9 Connector Kit	PSU-Series, PFR-Series
PSU-485	RS485 Cable with DB9 Connector Kit	PSU-Series, PFR-Series
PSU-GPIB	PSU GPIB Interface Card (Factory Installed)	PSU-Series
PSU-ISO-I	Isolated Current Remote Control Card (Factory Installed)	PSU-Series
PSU-ISO-V	Isolated Voltage Remote Control Card (Factory Installed)	PSU-Series
PSW-001	Accessory Kits	PSW-Series, PSW-Multi Series, PSB-1000 Series
PSW-002	Simple IDC Tool	PSW-Series, PSW-Multi Series, PSB-1000 Series
PSW-003	Contact Removal Tool	PSW-Series, PSW-Multi Series, PSB-1000 Series
PSW-004	Basic Accessory Kit for 30V/80V/160V models	PSW-Series, PSW-Multi Series
PSW-005	Series Operation Cable for 2 units(30V/80V/160V models moly)	PSW-Series
PSW-006	Parallel Operation Cable for 2 units	PSW-Series
PSW-007	Parallel Operation Cable for 3 units	PSW-Series
PSW-008	Basic Accessory Kit for 250V/800V models	PSW-Series
PSW-009	Output Terminal Cover for 30V/80V/160V models	PSW-Series
PSW-010	Large Filter (Type II/III)	PSW-Series
PSW-011	Output Terminal Cover for 250V/800V models	PSW-Series
PSW-012	High Voltage Output Terminal for 250V/800V model	PSW-Series

ACCESSORIES

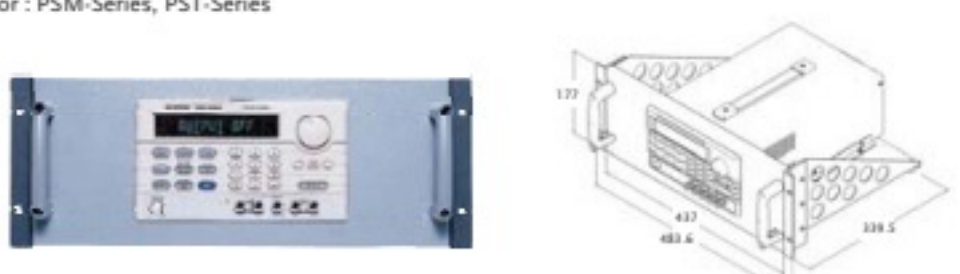
<p>GTL-101</p> 	<p>GTL-105A</p> 	<p>GTL-104A</p> 
<p>GTL-120</p> 	<p>GTL-121</p> 	<p>GTL-122</p> 
<p>GTL-123</p> 	<p>GTL-201A</p> 	<p>GTL-202</p> 
<p>GTL-203A</p> 	<p>GTL-204A</p> 	<p>GTL-218</p> 
<p>GTL-219</p> 	<p>GTL-220/GTL-222</p> 	<p>GTL-221/GTL-223</p> 
<p>GTL-232/GTL-232A</p> 	<p>GTL-240</p> 	<p>GTL-246</p> 
<p>GTL-248</p> 	<p>GTL-249</p> 	<p>GTL-250</p> 

ACCESSORIES

<p>GTL-253</p> 	<p>GTL-258</p> 	<p>GTL-259</p> 	
<p>GTL-260</p> 	<p>GTL-261</p> 	<p>GTL-262</p> 	
<p>GRA-401 Rack Mount Kit</p> 		<p>GRA-408 Rack Mount Kit</p> 	
<p>PEL-002 Rack Mount Kit For : PEL-2000A Series</p> 		<p>GRA-409 Rack Mount Kit For : APS-1102A</p> 	
<p>GRA-403 Rack Mount Kit For : PSH-Series</p> 		<p>GRA-410-J Rack Mount Kit (JIS) For : PSW-Series</p> 	
<p>GRA-407 Rack Mount Kit For : PSM-Series, PST-Series</p> 		<p>GRA-410-E Rack Mount Kit (EIA) For : PSW-Series</p> 	
<p>GRA-413-J Rack Mount Kit (JIS) For : PEL-3211/3211H</p> 		<p>GRA-414-J Rack Mount Kit (JIS) For : PEL-3021/3021H/3041/3041H/3111/3111H PEL-3031E/3032E</p> 	

ACCESSORIES

GRA-413-E Rack Mount Kit (EIA)

For : PEL-3211/3211H



GRA-414-E Rack Mount Kit (EIA)

For : PEL-3021/3021H/3041/3041H/3111/3111H
PEL-3031E/3032E



GRA-423 Rack Mount Kit

For : APS-7050/7100/7050E/7100E Series

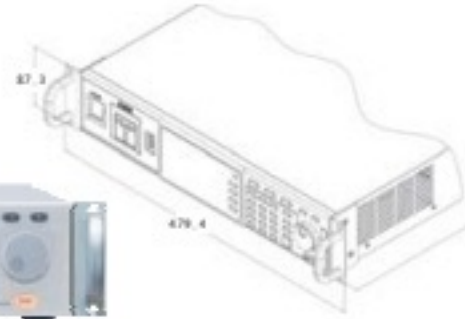

GRA-424 Rack Mount Kit

For : PSB-2000 Series

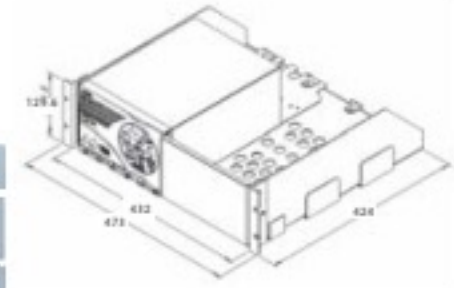

GRA-418-J Rack Mount Kit (JIS)

For : PSB-1000 Series

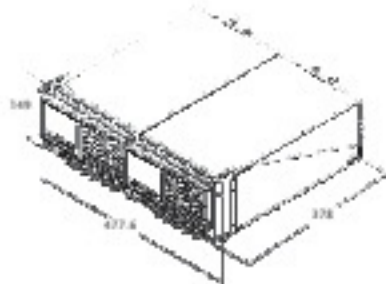

GRA-419 Rack Mount Kit (JIS)

For : PCS-1000I

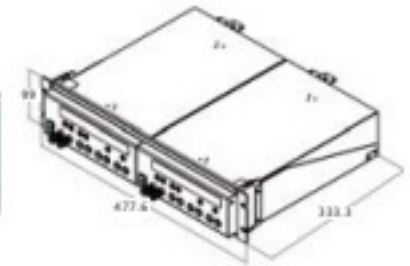

GRA-418-E Rack Mount Kit (EIA)

For : PSB-1000 Series

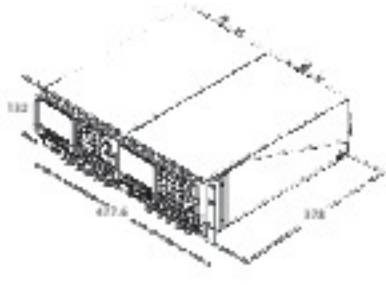

GRA-419 EIA Rack Mount Kit

For : PCS-1000

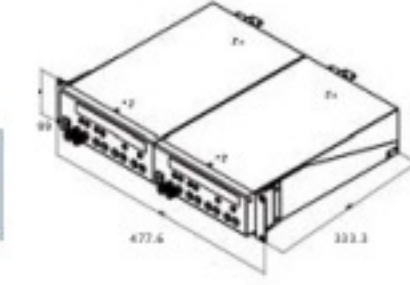

GRA-424 Rack Mount Kit

For : PSB-2000 Series

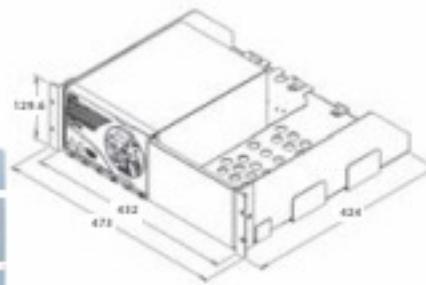

GRA-428 Rack Mount Kit (EIA)

For : PSP-Series

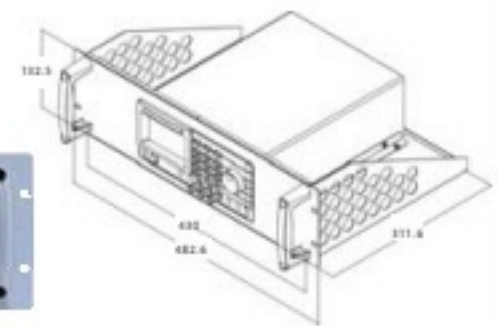

GRA-429 Rack Mount Kit For : APS-7200 S

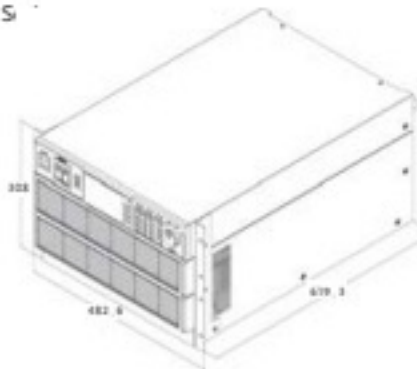

GRA-430 Rack Mount Kit For : APS-7300 Series

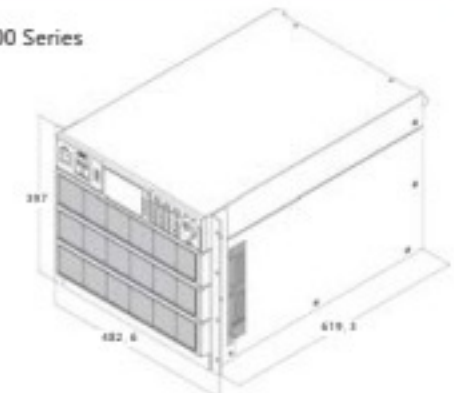

GRA-431-J Rack Mount Kit (JIS) with AC 100V/200V

For : PFR-Series

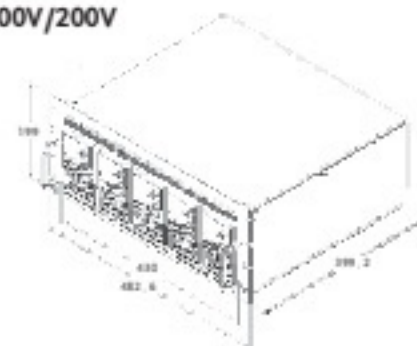





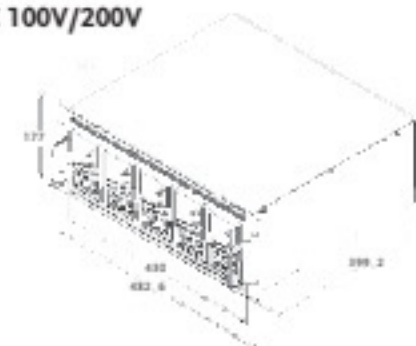



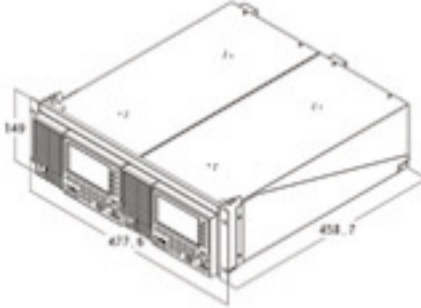

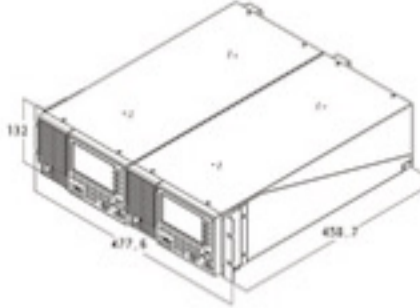

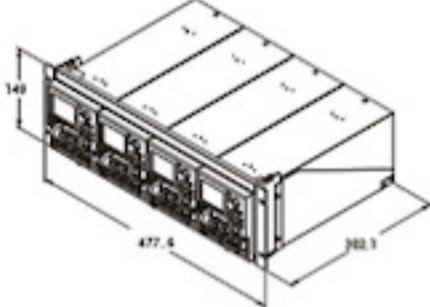

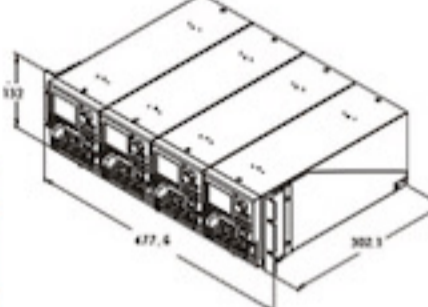

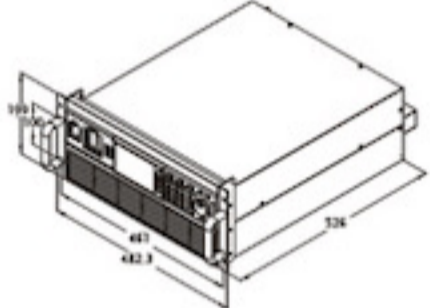

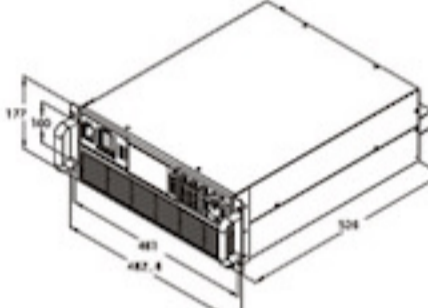
GRA-431-E Rack Mount Kit (EIA) with AC 100V/200V

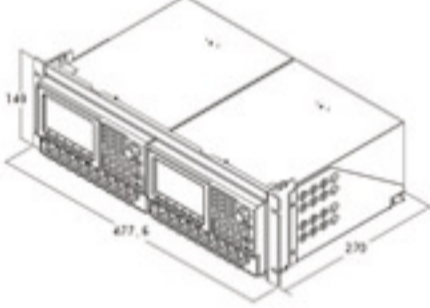
For : PFR-Series

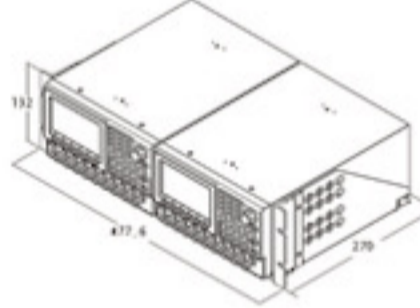

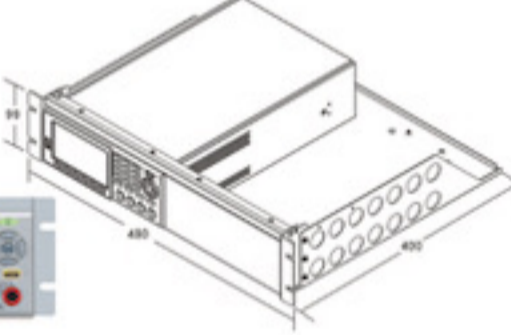
ACCESSORIES

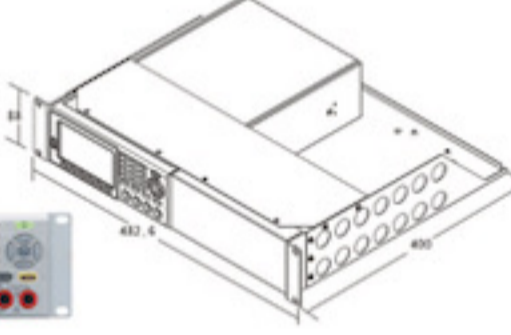
<p>GRA-439-J Rack Mount Kit (JIS) For : ASR-2000 Series</p>  	<p>GRA-439-E Rack Mount Kit (EIA) For : ASR-2000 Series</p>  
<p>GRA-441-J Rack Mount Kit (JIS) For : PPX-Series</p>  	<p>GRA-441-E Rack Mount Kit (EIA) For : PPX-Series</p>  
<p>GRA-442-J Rack Mount Kit (JIS) For : ASR-3000 Series</p>  	<p>GRA-442-E Rack Mount Kit (EIA) For : ASR-3000 Series</p>  
<p>GRA-449-J Rack Mount Kit (JIS) For : GPP-Series</p>  	<p>GRA-449-E Rack Mount Kit (EIA) For : GPP-Series</p>  
<p>GRA-450-J Rack Mount Kit (JIS) For : GSM-20H10, PPH-Series</p>  	<p>GRA-450-E Rack Mount Kit (EIA) For : GSM-20H10, PPH-Series</p>  

For more information, please visit our website: <http://www.gwinstek.com>

DISTRIBUTOR :



Zone Acticentre -Bâtiment H - 156/220
Rue des Famards - CRT2 - CS 10210 - 59273 FRETIN
Tél. 03 20 62 06 80 Télécopie : 03 20 96 95 62
E-mail : contact@dimelco.com

Specifications subject to change without notice.

2023-24PCL-2023.08-500

Global Headquarters

GOOD WILL INSTRUMENT CO., LTD.

No.7-1, Jhongsing Road, Tucheng Dist., New Taipei City 236, Taiwan
T +886-2-2268-0389 F +886-2-2268-0639
E-mail: marketing@goodwill.com.tw

China Subsidiary

GOOD WILL INSTRUMENT (SUZHOU) CO., LTD.

No. 521, Zhujiang Road, Snd, Suzhou Jiangsu 215011 China
T +86-512-6661-7177 F +86-512-6661-7277

Malaysia Subsidiary

GOOD WILL INSTRUMENT (SEA) SDN. BHD.

No. 1-3-18, Elit Avenue, Jalan Mayang Pasir 3,
11950 Bayan Baru, Penang, Malaysia
T +604-6111122 F +604-6115225

Europe Subsidiary

GOOD WILL INSTRUMENT EURO B.V.

De Run 5427A, 5504DG Veldhoven, THE NETHERLANDS
T +31(0)40-2557790 F +31(0)40-2541194

U.S.A. Subsidiary

INSTEK AMERICA CORP.

5198 Brooks Street Montclair, CA 91763, U.S.A.
T +1-909-399-3535 F +1-909-399-0819

Japan Subsidiary

TEXIO TECHNOLOGY CORPORATION.

7F Towa Fudosan Shin Yokohama Bldg., 2-18-13 Shin
Yokohama, Kohoku-ku, Yokohama, Kanagawa,
222-0033 Japan
T +81-45-620-2305 F +81-45-534-7181

Korea Subsidiary

GOOD WILL INSTRUMENT KOREA CO., LTD.

Room No.503, Gyeonginro 775 (Mullae-Dong 3Ga,
Ace Hightech-City B/D 1Dong), Yeongduengpo-Gu,
Seoul 150093, Korea.
T +82-2-3439-2205 F +82-2-3439-2207

India Subsidiary

GW INSTEK INDIA LLP.

No.2707/B&C, 1st Floor UNNATHI Building,
E-Block, Sahakara Nagar, Bengaluru-560 092. India
T +91-80-6811-0600 F +91-80-6811-0626

GW INSTEK

Simply Reliable



Website



Facebook



LinkedIn