



# **User Manual**

## **505U-K Radio Telemetry Module**

*for 505K-2-E, -B, refer to separate User Manual*

*ELPRO Technologies Pty Ltd, 9/12 Billabong Street, Stafford Q 4053, Australia.*

*Tel: +61 7 33524533 Fax: +61 7 33524577 Email: [sales@elpro.com.au](mailto:sales@elpro.com.au)*

*Web: [www.elpro.com.au](http://www.elpro.com.au)*

Thank you for your selection of the 505U-K module for your telemetry needs. We trust it will give you many years of valuable service.

## **ATTENTION!**

Incorrect termination of supply wires may cause internal damage and will void warranty.

To ensure your 505U-K enjoys a long life,  
**double check ALL your connections with  
the user's manual**  
before turning the power on.

## **WARNING**

1. For 505K modules, a radio licence is not required in most countries, provided the module is installed using the antenna and equipment configuration permitted. Check with your local 505U distributor for further information on regulations.
2. For 505U modules, operation is authorised by the radio frequency regulatory authority in your country on a non-protection basis. Although all care is taken in the design of these units, there is no responsibility taken for sources of external interference. Some delay in the operation of outputs may occur during periods of interference. Systems should be designed to be tolerant of these delays.
3. To avoid the risk of electrocution, the antenna, antenna cable, serial cables and all terminals of the 505U module should be electrically protected. To provide maximum surge and lightning protection, the module should be connected to a suitable earth and the antenna, antenna cable, serial cables and the module should be installed as recommended in the Installation Guide.
4. The 505U module is not suitable for use in explosive environments without additional protection.

# 505U-K Radio Telemetry Module USER MANUAL

<b>1</b>	<b>OVERVIEW</b>	<b>6</b>
1.1	INPUT SIGNALS	6
1.2	POWER SUPPLY	7
1.3	RADIO TRANSMITTER	7
1.4	CONFIGURATION	7
<b>2</b>	<b>OPERATION</b>	<b>9</b>
2.1	NORMAL OPERATION	9
2.2	WHAT INFORMATION IS TRANSMITTED OVER THE RADIO?	9
2.3	HOW OFTEN IS THE INPUT INFORMATION SENT BY RADIO?	9
2.4	INPUTS	10
2.4.1	<i>Digital Inputs</i>	10
2.4.2	<i>Pulse Inputs</i>	10
2.4.3	<i>Shaft Encoder Inputs</i>	12
2.4.4	<i>Pulse Rates</i>	12
2.4.5	<i>Analogue Inputs</i>	13
2.4.6	<i>Setpoint Status</i>	14
2.4.7	<i>Supply Voltage</i>	15
2.4.8	<i>Low Supply Voltage Alarm (Supply LowVolts)</i>	15
2.4.9	<i>Supply Failure</i>	15
2.4.10	<i>Communications Failure</i>	15
2.5	HOW TO DESIGN A REMOTE MONITORING SYSTEM	16
2.5.1	<i>Achieving reliable radio transmission</i>	16
2.5.2	<i>How far will the radio transmit?</i>	17
2.6	CALCULATING POWER CONSUMPTION	18
<b>3</b>	<b>HARDWARE INSTALLATION</b>	<b>21</b>
3.1	HOW TO MOUNT THE 505K	21
3.2	ANTENNA INSTALLATION	22
3.2.1	<i>Dipole antenna</i>	23
3.2.2	<i>Yagi antenna</i>	24
3.2.3	<i>Collinear antenna</i>	25
3.3	CONNECTION PLUG	25
3.3.1	<i>PL1-K Plug Lead</i>	26
	POWER SUPPLY	27
3.4.1	<i>Battery Pack BU-5</i>	27
3.4.2	<i>External Power</i>	28
3.5	INPUT SIGNAL CONNECTIONS	28
3.5.1	<i>Digital/Pulse Inputs</i>	28

---

3.5.2	<i>Shaft Encoder Connections</i> .....	29
3.5.3	<i>Analogue input</i> .....	29
3.5.4	<i>RS232 serial port</i> .....	30
<b>4</b>	<b>CONFIGURATION</b> -----	<b>32</b>
4.1	I/O MAPPING.....	33
4.2	UPDATE TRANSMISSION TIMES.....	34
4.3	DIGITAL INPUTS .....	34
4.4	ANALOGUE INPUT.....	35
4.5	ANALOGUE SETPOINTS.....	36
4.6	SUPPLY VOLTAGE .....	37
4.7	PULSE INPUTS .....	38
4.7.1	<i>Manually Setting Counter Values</i> .....	41
4.7.2	<i>Shaft Encoder Inputs</i> .....	41
4.7.3	<i>Pulse Rates</i> .....	41
4.8	NUMBER OF TRANSMISSIONS .....	42
4.9	PROGRAMMING CONFIGURATION FROM TO MODULE.....	42
4.10	LOADING CONFIGURATION FROM A MODULE .....	42
4.11	PRINT OPTIONS .....	43
<b>5</b>	<b>DIAGNOSTICS AND TESTING</b> -----	<b>44</b>
5.1	SYSTEM PROBLEMS .....	44
5.2	LED INDICATORS.....	44
5.3	DIAGNOSTIC FEATURES.....	44
5.3.1	<i>Read Inputs</i> .....	45
5.3.2	<i>Setting Counter Values</i> .....	45
5.3.3	<i>Calibrating Analog Input</i> .....	46
5.3.4	<i>Tone Reversals</i> .....	47
5.3.5	<i>Firmware Version</i> .....	47
<b>6</b>	<b>SPECIFICATIONS</b> -----	<b>48</b>
<b>7</b>	<b>WARRANTY</b> -----	<b>50</b>

# 1 OVERVIEW

*Note: Please refer to the separate 505U-2 User Manual for the 505U-2-E and 505U-2-B products. The 505U-K product will be referred to as the “505K” for the rest of this manual to clearly delineate it from the other 505U products.*

The 505K radio telemetry module is an economical solution for the remote monitoring of process signals. The 505K can connect to digital, pulse or analogue signals from process transducers, and transmit these signal values by radio.

Although the 505K is intended to be simple in its application, it also provides many sophisticated features. This manual should be read carefully to ensure that the modules are configured and installed to give reliable performance. The 505K has been designed to use a European licence-free radio band at 869MHz. The 505K uses the 869MHz 105U module as a receiver, or repeater. If you have not used 105U modules before, please read the 105U User Manual prior to reading this manual.

The 505K module is a monitoring only unit - that is, it will **only accept input signals** and does not provide output signals. The 505K has an internal radio transmitter; it does not have a receiver to receive messages from another module.

The 505K transmits the value of an input signal whenever the signal changes, and also after a pre-configured time. Each transmission message includes error-checking to confirm the validity of the message. At each transmission, the 505K may be configured to repeat the transmission several times to ensure that the transmission is received correctly. This is important if the radio path is marginal (that is, the radio signal is not strong) or if there is a lot of radio traffic on the radio channel which may corrupt the 505K message. The 505K transmits the input message to a 105U module, which sets an output signal to be the same value as the 505K input, or the 105U passes the input message to another device (PC or PLC) via its serial port.

For more information on the 105U module, please refer to the 105U User Manual.

The 505K has a heavy duty painted aluminium enclosure, weather-proof to IP66. Signal and power connections to the unit are made via a weatherproof connector at the bottom of the module. Antenna connection is made using a SMA coaxial connector at the top of the module.

## 1.1 Input Signals

The 505K module provides two digital/pulse inputs and one analogue input for connecting to process transducers.

### *Digital* Signals

Examples: motor fault, tank overflow, intruder alarm

*Pulse* signals - use the same input as the digital input

Examples: electricity metering, fluid flow, raingauge, level from a shaft encoder

**Analogue** continuously variable signals (0-20mA, 4-20mA, 0-10mA, 0-10V)

Examples: measured tank level, measured process temperature

Some **internal** signals may also be transmitted to outputs in the network:

- Setpoint Status (digital signal set or reset depending upon the value of the analogue signal compared to a high and a low setpoint value configured in the 505K)
- Supply Low Voltage (digital signal set when supply voltage is low).
- Supply Voltage (analogue value)
- Pulse Rate (analogue value proportional to rate of pulse input - available for both pulse inputs)

## 1.2 Power Supply

The power consumption of the 505K is very small as it conserves power by reverting to “sleep” mode between transmissions. The 505K can be powered from a 6 - 30 VDC supply. An optional 9VDC battery pack, the BU-5 is available to power the 505K. The battery supply uses six AA alkaline batteries. More than one BU-5 battery pack can be connected together to supply a 505K. Other battery supplies can also be used to power the 505K, including a solar panel supply.

The 505K unit provides an internal alarm on low supply voltage - this alarm may be transmitted by radio for warning purposes. The user can configure the voltage at which the low voltage alarm activates.

The 505K generates a 24VDC, 50mA supply for powering the analogue loop. This supply is designed to power an analogue loop only and should not be used for any other purpose.

## 1.3 Radio Transmitter

The 505K has an internal radio transmitter that operates on a unlicensed radio channel at 869.4 – 869.65 MHz. A radio licence is not required for the 505K in many European countries and has an operating range of up to five kilometres.

It is suitable for use in utility industries such as electricity, water and gas, as well as a cost effective solution for short range applications in factories and industrial plants.

To **extend radio range**, 105U modules can be used as repeaters. Up to five repeaters can be configured for each input-to-output link. The configuration is done at the 505K module where the input signal is - no additional configuration is required at the 105U modules. The transmitted radio message will include the address of repeater modules - modules with these addresses will re-transmit the messages.

## 1.4 Configuration

Each module must be configured before it can be used. Configuration is performed using a PC (or a laptop computer) connected to the module via the internal RS232 port on the 505K.

505K configuration software is required and is provided with each order.

Configuring a module requires the entering of “input mappings” and setting operating parameters for each input. An “input mapping” links an input signal to an output channel at a remote module (or a “destination address”). An input mapping is entered for each input signal (external and internal) which is used. Mappings may be inverted such that the output is the reverse value of the input.



## 2 OPERATION

### 2.1 Normal Operation

Once configured using the 505K configuration software, the 505K module will normally be in “sleep” mode to conserve power. During sleep mode, the microprocessor controller powers down, and the analogue loop supply is turned off. The microprocessor will automatically “wake up” and revert to full operation if a digital/pulse input changes (*on* to *off*, or *off* to *on*), or every 0.5 seconds to check if a timed update transmission is due to be sent.

Normal operation of the 505K is indicated by a brief flicker of the OK LED light on the front panel approximately every 10 seconds.

### 2.2 What information is transmitted over the radio?

The 505K modules transmit the value of the input signal in a data frame. The data frame includes a system address, and the “address” of the transmitting (or “source”) 505K module and the receiving (or “destination”) 105U module, so that each transmitted message is acted on only by the correct receiving unit. The system address is a common address used by all modules in the same system. This allows multiple systems to operate within the same radio range without “cross-talk” between systems.

The user configures these addresses as part of the module configuration. Each transmitted message also includes error checking to ensure that no corruption of the data frame has occurred due to noise or interference. If repeater modules are being used, then the addresses of these intermediate modules are also included in the data frame.

The user can configure the 505K to transmit each message from one to five times to ensure that at least one of the messages is received correctly. Each repeat transmission will occur at random intervals between one and four seconds.

### 2.3 How often is the input information sent by radio?

- Change messages. The 505K transmits the value of an input signal whenever the signal changes.
- Update messages. The input value is also transmitted if the signal has not changed within a pre-configured update time (configurable 10 seconds to 7 days).
- Paralysis. When a 505K transmits a message for a particular input, the 505K will not transmit another message for this input within a configured time period. This time is called the paralysis time, and may be used to prevent a lot of messages being transmitted if an input changes frequently. The paralysis time may be set from zero to 127.5 seconds for each input. For example, assume the paralysis time on an input is 30 seconds. If the input changes, then the 505K will transmit a message, however it will not transmit another message for this input during the next 30 seconds, regardless of changes to the input signal. Note that paralysis time does not stop re-transmissions of each message - if the 505K is configured to transmit each message three times, then paralysis will not stop

this.

Depending on the type of input signal (digital, pulse or analogue), the 505K must determine what type of signal change is required to send a transmission:

## 2.4 Inputs

### 2.4.1 Digital Inputs

A digital input can be an external digital input or an internal status input (setpoint status or low voltage alarm). The 505K will accept digital inputs as voltage-free contacts, NPN devices (such as proximity switches) or TTL signals. For TTL signals, a 0-1.5V signal will be measured as on/active/1, and a 3.5-13V signal will be measured as off/inactive/0.

The 505K will transmit the value of the digital input whenever it changes from off to on or from on to off. A paralysis time may be configured to prevent another transmission within this time. The 505K will also transmit an update message if a message has not been transmitted for that input within an “update time”.

There are two update times for each digital input - one for when the input is on, and one for when the input is off. Each update time may be configured between 10 seconds and 5 days. For example, a digital input may be configured to update every 1 day when the input is off, but update every 10 minutes when the input is on. If an update time of zero (or less than 10 seconds) is selected, then no update messages will be sent.

Overview:

- Input value transmitted on input change
- Update message if the input value has not been transmitted within the configured update time for that input (10 seconds - 7 days)
- Separate update times for on and off status for digital inputs
- After each transmission, further transmission for that input is disabled for the paralysis time (0 – 127.5 sec).

The time response of the two digital inputs is different. DI1 has a fast response, sensing a change within 10msec. This means that the overall “input-to-output” response is approx 50 msec. DI2 is checked every 500msec - the maximum response time of this input could be 550 msec.

### 2.4.2 Pulse Inputs

Pulse inputs use the same input connection as the digital inputs. The total number of digital and pulse inputs available is two.

Each pulse input is counted as two 16 bit registers. The first register is the pulse count, and the second register is the count of “overflows” of the first register - these two registers provide a 32 bit count of the pulse input. Each register can be transmitted individually. A “sensitivity” value is configured for each pulse input (0 - 32 000). Whenever the pulse count has increased by this value since the last transmission, the 505K will transmit the new pulse

---

count. In addition, an update transmission of the pulse count will be transmitted if the pulse count has not been transmitted for the update time. If an update time of zero is selected, then no update messages will be sent.

The maximum pulse input is:

- 300Hz for contact or NPN inputs (1 msec minimum on-time and off-time), or
- 10KHz (30  $\mu$ sec minimum on-time and off-time) for TTL inputs. Up to 50KHz can be achieved on PI2 provided the divider is set such that the scaled count rate is less than 10KHz (see below).

There is no minimum pulse rate. For PI2, there is a configurable scaling divider (integer 1 – 255). This allows the pulse count to be scaled. If a divider of X is configured, then the pulse count will increase by 1 for each X input pulses. There is a separate divider for each pulse input. The divider parameter could be used for the following reasons:

- If the pulse count is to be transmitted to a pulse output on a 105U, then the maximum pulse rate is 100Hz. If the input rate is more than 100Hz, then it can be reduced with the divider. For example, if the maximum input rate is 300Hz, then the use of a 10 divider will bring the effective rate down to 30Hz - each output pulse will then represent 10 input pulses.
- The divider can be used to scale the pulse count to engineering units. For example, if the input pulse rate is 7 pulses per  $m^3$  of gas, then a divider of 7 will result in a pulse count corresponding to the number of  $m^3$ . Note that the divider must be an integer.
- The divider could be used to slow down the pulse rate. If the input pulse rate is 5KHz, then the base 16 bit counter will overflow in approx 13 seconds. If the overflow counter is not used, then this may be too fast to be processed by HMI software. If a divider of 100 is used, then the counter will take over 20 minutes to overflow.

There is no divider for PI1.

If the pulse count is transmitted to a pulse output on a 105U module, the 105U will compare the input count to its own output count (the count of output pulses), and will then output pulses until the two counts are the same. If the pulse counts are transmitted to a 105U-C interface module, then the 105U-C will store the pulse count value in an internal register.

For pulse rates higher than 10 Hz, the “Fast Pulsed Inputs” option should be selected. This increases power consumption of the module significantly and is not suitable for a battery power supply.

Overview:

- Pulse inputs are counted as 2 x 16 bit registers.
- Pulse count is transmitted when the count has increased by the sensitivity amount since the last transmission.
- Update message if the input value has not been transmitted within the update time (10 seconds - 7 days).

- After each transmission, another transmission for that input is disabled for the paralysis time (0 – 127.5 sec).
- PI2 can be scaled by a configurable divider.

The diagnostics functions of the 505K allow the user to manually set the counter values to any value (refer section 5 of this manual). On initial start-up of the modules, the counter values will be zeroed. If the module loses power, the 505K will save the counter values to non-volatile memory before shutting down - these values will be restored when power is restored.

### 2.4.3 Shaft Encoder Inputs

The two pulse inputs may be configured to control one up/down count value, for use with quadrature and incremental shaft encoders. A shaft encoder is a transducer that measures level or displacement, and has two pulse signals to indicate change of level and direction of change. Both pulse inputs are read at the same time. The divider parameter on PI2 must be set to 1 for this application.

If an incremental encoder is used, then the calculated count value is stored in PI1. If a quadrature encoder is used, then the calculated count value is stored in PI2.

The counter value (or “level position”) can be manually set using the 905K diagnostics features (refer section 5 of this manual). Initially the counter will need to be “zeroed” when the shaft encoder is in the “zero level” position.

### 2.4.4 Pulse Rates

The rate of each pulse count is calculated and can be transmitted as internal analogue inputs. The rate is calculated on the increase of the base counter, not the rate of the input pulses. The maximum count rate which can be calculated is 1000Hz. For PI1, this is the maximum pulse rate that can be calculated. For PI2, a divider can be used for pulse rates more than 1KHz. The pulse rate values can be scaled - that is, the user can configure what pulse rate (0.1 – 1000Hz) corresponds to maximum analogue value (20mA). Each pulse rate can be scaled individually. Note that this is separate to the divider on PI2 count.

If the pulse inputs are configured for a shaft encoder, a pulse rate is still calculated - corresponding to rate change of level. A zero rate (“steady level”) will correspond to a 50% analogue signal. The analogue signal will be more than 50% if the level is increasing, and less than 50% if the level is decreasing. If an incremental shaft encoder is used, then the rate may be scaled by scaling PRATE1. If a quadrature encoder is used, scale PRATE2. The scaling value will determine both the 100% analogue signal (e.g. 20mA) and 0% signal (e.g. 4mA). For example, if a maximum pulse rate of 10Hz is configured, then the analogue signal will be:

100% if the encoder increases at 10Hz	50% if the encoder pulse rate is 0
0% if the encoder decreases at 10Hz.	75% if the encoder increases at 5Hz
25% if the encoder decreases at 5Hz	

Note that this is only true if the pulse inputs are configured for a shaft encoder. If standard

---

pulse inputs are used, then 0% analogue signal will correspond to zero pulse rate (0Hz).

The pulse rates are treated as analogue inputs and follow the rules for an analogue input as described below.

### 2.4.5 Analogue Inputs

The analogue input can measure from 0 – 24mA or 0 – 10VDC. Current or voltage input can be selected by an internal selector (refer Installation section of this manual). The mA input can be used for conventional 4-20mA signals or 0-10mA or 0-20mA. The voltage input can be used for 0-5 or 0-10VDC signals. The 505K unit is factory configured for a 4-20mA signal, however the user can calibrate the unit for other ranges. The measurement resolution is 12 bit.

The analogue input uses a “sample time” and “warm-up time” configured by the user. The sample time (0 – 32727 sec or 9.1hours) “wakes” the 505K from sleep mode and turns on the analogue loop supply. The “warm-up time” (0 – 100 seconds) allows the transducer to reach rated accuracy before the 505K makes a measurement of the analogue signal.

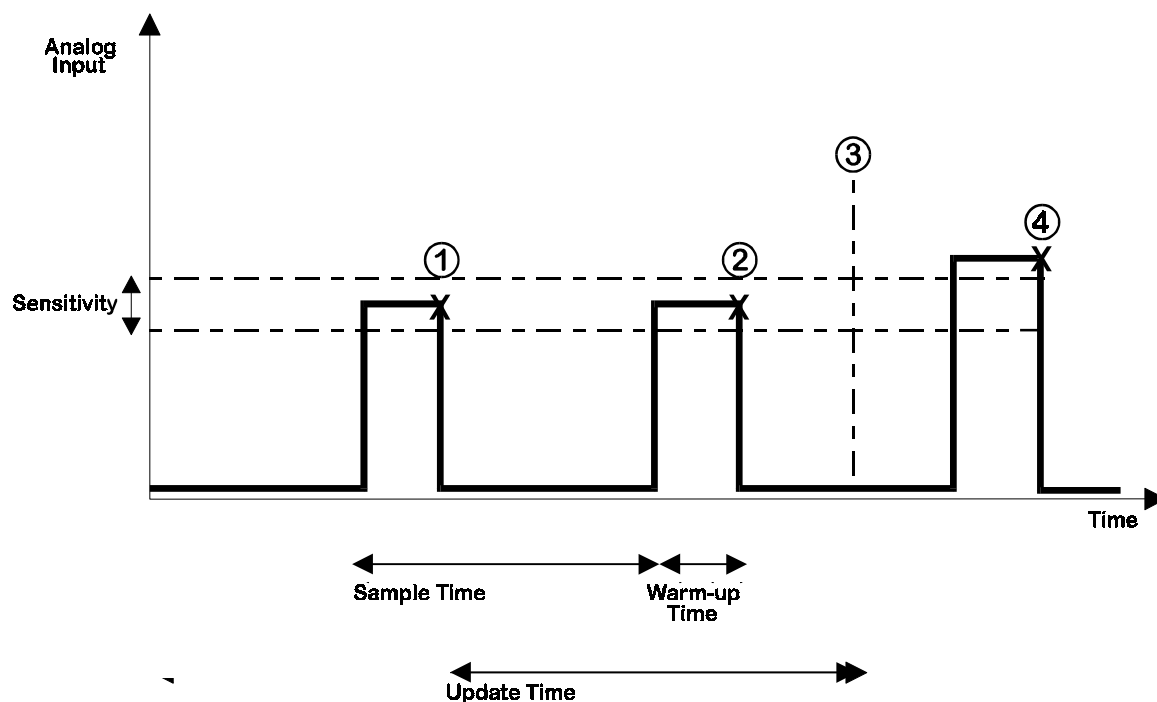

- ① Measurement taken and input value transmitted.
- ② Measurement taken - as input value has not changed by more than sensitivity, no transmission.
- ③ Update time reached, last measured value is transmitted.
- ④ Measurement taken - as input value has changed by more than the sensitivity, the input value is transmitted.

For example, if the sample time is 30 minutes and the warm-up time is 10 seconds, then every 30 minutes, the 505K will turn on its analogue loop supply and after a further 10 seconds, take a measurement of the analogue signal. After the measurement is taken, the 505K reverts

to sleep mode. The loop voltage available for a transducer is approx. 24VDC.

If the warm-up time is set to the same or more than the sample time, then the analogue loop will be on continuously, and the 505K will measure the signal based on the sample time. For example, if the sample time is 10 seconds, and the warm-up time 20 seconds, then the analogue loop will be continuously active and a measurement made every 10 secs. If the sample time is set to zero, then a measurement is made every cycle of the 505K - that is, 0.5 sec.

Note that continuous analogue loop operation will result in a short battery life if a battery supply is used. A solar panel and battery supply is suitable.

If an externally powered analogue signal is connected, then the same measurement process as described above occurs .

When the 505K takes a measurement, it will transmit the analogue value if the value has changed by more than the pre-configured sensitivity since the last transmission. The sensitivity can be configured from 0.1% to 75% with a default value of 3%. If the change in the signal since the last transmitted value is less than the sensitivity, then the 505K will not transmit the analogue value.

The sensitivity value should be selected which is more than the normal analogue signal noise. If the sensitivity is less than the signal noise, then the 505K will send a lot of un-necessary transmissions, possibly resulting in jamming the radio channel.

An update transmission of the analogue value will be transmitted if the analogue value has not been transmitted for during the user-configurable update period (10 seconds - 7 days). If an update time of zero is selected, then no update messages will be sent.

If the update time expires since the last transmission, then the last measured value will be transmitted - that is, a new measurement will not be taken. Normally the update time will be much longer than the sample time. If the update time is less than the sample time, then update messages may transmit the same value as the previous transmission, as a new measurement has not yet been taken.

Overview:

- Measurements of the analogue signal are determined by the sample time and warm-up time
- Analogue value is transmitted if the measured value has increased by the configured sensitivity amount since the last transmission
- Analogue value is transmitted if the input value has not been transmitted within the update time (10 seconds – 7 days)
- There is no paralysis time for the analogue input.

#### **2.4.6 Setpoint Status**

The setpoint status is an internal status value, calculated by comparing the analogue input to two configurable setpoint values. The setpoint status turns ON when the analogue input moves below the low setpoint value, and turns OFF when it moves above the high setpoint

value. The high setpoint percentage must always be greater than, or equal to, the low set point.

The internal setpoint status will be determined every time an analogue measurement is taken.

The setpoint status is treated as a digital signal and its value is transmitted according to the rules for a digital input.

#### **2.4.7 Supply Voltage**

The 505K measures the supply voltage and stores it as an internal “analogue” value. The range of the analogue value is 0 – 30 volts. The measurement is made every time the radio transmits (the measured value is the “loaded” supply voltage) and the measurement is transmitted based on the user-configurable update time - there are no change transmissions for this value.

#### **2.4.8 Low Supply Voltage Alarm (Supply LowVolts)**

If the voltage of the power supply falls below the pre-configured alarm value, the internal low voltage alarm will turn on. The 505K provides user-configurable high and low setpoints for the supply voltage value. If the supply voltage falls below the low SP, then the Supply Low Volts status will turn on. When the supply voltage increases above the high SP, the status will turn off. The low SP should not be set less than 5.7V.

The Supply Low Volts is treated as a digital signal and its value is transmitted according to the rules for a digital input.

#### **2.4.9 Supply Failure**

The 505K will stop operating if the supply voltage falls below 95% of the Supply LOV value. Prior to shutting down, the 505K will store the values of the pulse counters in non-volatile memory. The unit will restart when the supply voltage has increased to the configured high SP value.

#### **2.4.10 Communications Failure**

The 505K cannot provide an indication that its transmitted messages have not been received successfully.

This indication is however available at the **receiving 105U** by using the 105U Output Reset on Comms Fail function. To use this function, map an input that is not being used on the 505K to a spare output on the 105U. The unused input can be an internal input such as the Low Voltage status or Setpoint status, or even the analogue input as this can also be mapped to a digital output. Configure the 505K so that the digital output at the 105U is normally on - you can configure an input to output mapping to be inverted or direct.

If you configure a reset time to the 105U output, then this output will turn off if it has not received an update message from the 505K within that time. The 105U output is effectively a "Communications OK" output - on when communications are OK, and off during communications failure. Note that the maximum output reset time at the 105U is 32 minutes, so the update time for the 505K input must be less than this. It is generally a good idea to set the update time to less than half of the reset time. Then, the 105U must fail to receive two

consecutive update messages - it is possible to miss one update message because of random noise, but two consecutive failures means that there is a system failure.

For example, if you wish to have a failure alarm within 10 minutes of a system failure, set the output reset time at the 105U to 10 minutes and the update time at the 505K to 4.5 minutes.

## **2.5 How to Design a Remote Monitoring System**

### **2.5.1 Achieving reliable radio transmission**

A system can theoretically have an unlimited number of 505K modules, but in practice, the number is limited by the amount of radio traffic on one frequency in the system. When a radio channel becomes unreliable because of radio traffic, then a second radio channel must be used to increase the size of the system. This limit is not a function of the number of modules, but the number of radio messages.

A system comprises 505K and 105U modules - each can transmit input signals. The 105U can "hear" other radio messages, and will hold off transmitting a message until the radio channel is clear. The 505K module cannot, and there is a possibility that an individual transmission will clash with another transmission, and both transmissions will be corrupted. This possibility increases as the density of transmissions increases. Configuring the re-transmit feature (transmission of each message several times) will increase the chance of each message being received successfully, but will increase the overall density of radio traffic.

For large systems, a compromise is required between the number of re-transmissions, and the update times for each input. High priority inputs should have shorter update times than lower priority inputs.

The peak transmission density should be calculated for large systems. These values are calculated by determining the number of transmissions from inputs changing value and the number of update transmissions per hour.

The probability of success for an individual message depends on the transmission density and the number of re-transmissions for each message. This is shown in the following graph:



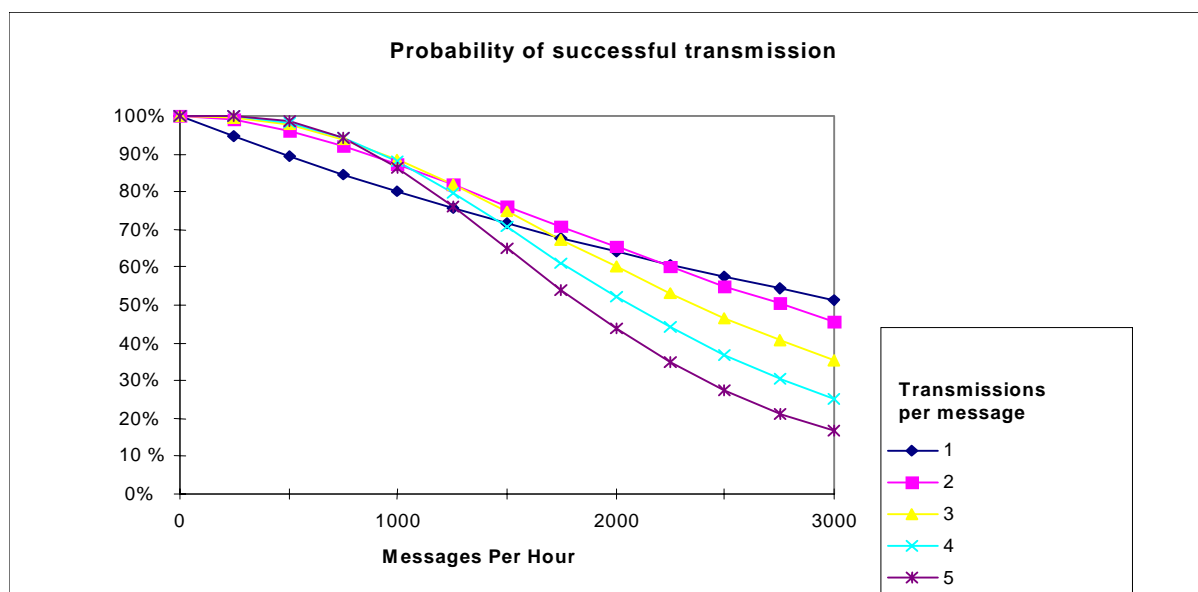

This assumes that the radio path is reliable and that there is no other radio users on this radio channel. If intermediate repeaters are used, then each repeated message should be counted as another message.

We suggest that you use two transmissions per message - with a higher number for a small number of high priority inputs.

In addition to the above comments, you need to consider the affect of re-transmissions on other messages being transmitted from the same 505K module. Once a 505K starts transmitting a message, all transmissions for this message must be complete before another transmission can start. The time between retransmissions of the same message is a random time between 0.5 and 74 seconds. For example, if a module is configured to transmit each message 5 times, then each message will take up to 16 seconds. Another message cannot be transmitted until the previous message has finished. In the above example, the maximum number of messages which can be transmitted reliably is approx 4 per minute. If more messages are required, then a lower number of re-transmissions should be selected.

### 2.5.2 How far will the radio transmit?

The 505K will operate reliably over approx. 5km line-of-sight. The distance that can be reliably achieved will vary with each application and is dependent on the following factors:

- Type and location of antennas (the higher an antenna is, the further it will transmit)
- Amount of radio interference from other transmitters or radio “noise”
- Obstructions such as buildings, hills or trees in the radio path.



No. of “off” update messages per year = 364 (approximately)

No. of “on” update messages per year = 2 (twice per year) \* 16 (4 hours @ 15 min update)  
= 32

Total messages for digital input = 4 + 364 + 32 = 400

**Pulse input** Update time 1 day Sensitivity 50

Average pulse rate is 1 pulse per hour, with peak rate of 20 per hour, for 10 hours, three times per year.

No. of change messages (normal rate) = 0 (time for 50 pulses is more than the update time)

No. of change messages (peak rate) = 3 (three per year) \* 200 (20 per hr for 10 hrs) / 50  
= 12

No. of update messages per year = 363 (approx)

Total messages for pulse input = 12 + 363 = 375

**Analogue input** Sample time 1 hour Warm-up time 5 secs

Sensitivity 3% Update time 1 day

Average changes of >3% is twice per day

No. of change messages per year = 2 (twice per day) \* 365  
= 730

No. of update messages per year = 0 (always be a change message each 1 day)

Total messages for analogue input = 730

Total input messages per year = 400 + 375 + 730 = 1505

**Power consumed in transmissions** = 0.005 \* 1505 \* 2 (2 transmissions per message)  
= 15 mAHr per year

**Power for analogue loop supply** (assume average loop current is 12mA)

No. of analogue measurements per year = 365 days \* 24 hours \* 1(sample time)  
= 8,760

Power for analogue loop supply = 0.012 (from above table) \* 5 (warm-up time) \* 8,760  
= 526 mAHr per year

**Power for pulse input**

Average pulse rate is 1 pulse per hour (0.0003Hz), so power required = 0.06 x 0.0003 per day  
= zero

**Quiescent power**

Power for quiescent current = 3.4 per day \* 365  
= 1241 mAHr per year

$$\begin{aligned} \text{Total power consumption per year} &= 15 + 526 + 0 + 1241 \\ &= 1782 \text{ mAHr} \\ \text{Expected battery life is} &= 1700/1782 = 0.95 \text{ year} \end{aligned}$$

Note that battery life is shortened during configuration or diagnostics. When the serial cable is connected to the 505K, the module does not revert to sleep mode and the power consumption is considerably increased. These periods should be minimised if you are using a battery pack.

## 3 HARDWARE INSTALLATION

**WARNING!** 110/220/240V mains power must NOT be connected to any input terminal of the 505K module!

The 505K module is housed in a weatherproof enclosure with external power and input signals connected via a weatherproof connector at the bottom of the module.

Wires of up to 0.75 sqmm may be connected by soldering to the female connector supplied with the unit. The antenna/coaxial cable connector is a SMA female at the top of the module. Care should be taken to ensure that this connection remains weatherproof, as the ingress of water will decrease radio performance. Wrap both the antenna connection and input signal connector with weatherproofing tape.

**Before installing a new system**, it is preferable to bench test the complete system as configuration problems are easier to recognise when the system units are close together.

Following installation, poor communications can be caused by:

- Incorrectly installed antennas
- Radio interference on the same channel
- Obstructions in the radio path
- Radio path too long

If the radio path is a problem, higher performance antennas or a higher mounting point for the antenna may help. Alternately, use a 105U module as a repeater.

The foldout sheet *505K Installation Guide* is included with the product, with more detailed information in the following sections:

### 3.1 How to mount the 505K

The 505K module is housed in an IP66 weatherproof aluminium enclosure. To mount the 505K, remove the four screws in the top plate, and carefully remove the cover. The two mounting holes should now be visible.

It is important to effectively earth the unit to help prevent radio noise and static electricity damage. The preferred method is to earth the module using the mounting screws to connect to an earthed surface. If this is not possible, use an earth

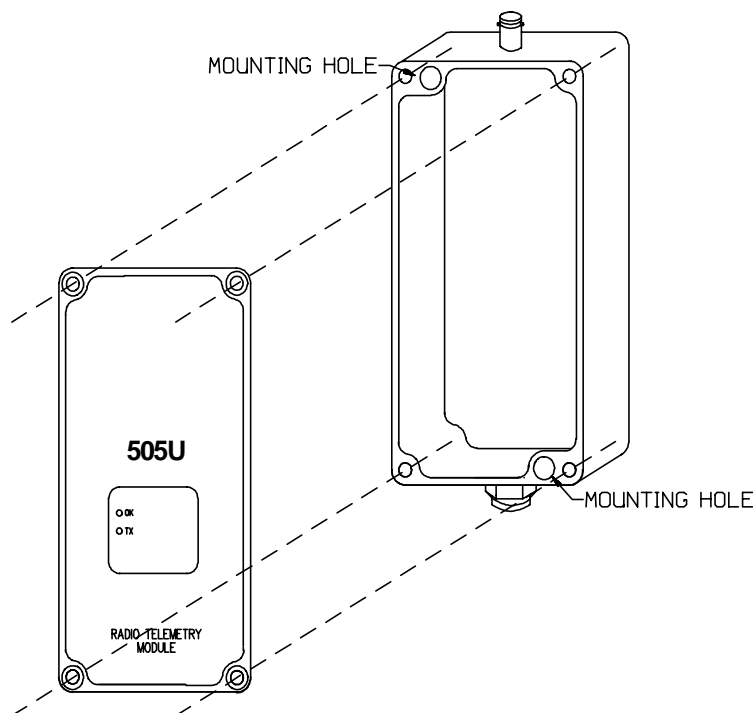

lug in the mounting screw connection and secure the other end of the wire to a good earth.

### 3.2 Antenna Installation

The 505K module will operate reliably up to 5km. The distance that may be reliably achieved will vary with each application - depending on the type and location of antennas, the degree of radio interference, and obstructions (such as hills or trees) to the radio path. Where it is not possible to achieve reliable communications, a 105U module may be used to receive the message and re-transmit it. This module is referred to as a repeater. This module may also have input/output (I/O) signals connected to it and form part of the I/O network.

An antenna must be connected to each 505K module using the SMA connector at the top of the enclosure. **It is important to weatherproof this connection by wrapping with waterproofing tape** (for example 3M 23 tape).

To achieve the maximum transmission distance, the antennas should be raised above intermediate obstructions so the radio path is true "line of sight". Because of the curvature of the earth, each antenna will need to be elevated at least 5 metres above ground for paths of 5 km (3 miles). For shorter distances, the modules will operate reliably with some obstruction of the radio path. Obstructions which are close to either antenna will have more of a blocking affect than obstructions in the middle of the radio path. For example, a group of trees around the antenna is a larger obstruction than a group of trees 100 metres from the antenna.

An antenna should be connected to the module via 50 ohm coaxial cable (eg RG58, RG213 or Cellfoil) terminated with a male coaxial connector. The higher the antenna is mounted, the greater the transmission range will be, however as the length of coaxial cable increases so do cable losses. It is important antenna are chosen carefully to avoid contravening the maximum power limit on the unlicensed channel - normally the net gain of the antenna/cable configuration should be **no more than 2dB**.

The net gain of an antenna/cable configuration is the gain of the antenna (in dBi) less the loss in the coaxial cable (in dB).

The gains and losses of typical antennas are

<b>Antenna</b>	<b>Gain (dB)</b>
Dipole with integral 5m cable	0
5dBi Collinear (3dBd)	5
8dBi Collinear (6dBd)	8
3 element Yagi	5
6 element Yagi	10
<b>Cable type</b>	<b>Loss (dB per 10 m)</b>
RG58	-5
RG213	-2.5
Cellfoil	-3

The net gain of the antenna/cable configuration is determined by adding the antenna gain and

---

the cable loss. For example, a 3 element Yagi with 10 metres of Cellfoil cable has a net gain of 2dB (5dB – 3dB).

Connections between the antenna and coaxial cable should be carefully taped to prevent ingress of moisture. Moisture ingress in the coaxial cable is a common cause for problems with radio systems, as it greatly increases the radio losses. We recommend that the connection be taped, firstly with a layer of PVC Tape, then with a vulcanising tape such as “3M 23 tape”, and finally with another layer of PVC UV Stabilised insulating tape. The first layer of tape allows the joint to be easily inspected when trouble shooting as the vulcanising seal can be easily removed.

Where antennas are mounted on elevated masts, the masts should be effectively earthed to avoid lightning surges. Where the antenna is mounted outside of an industrial plant environment, a coaxial surge diverter is recommended. If the antenna is not already shielded from lightning strike by an adjacent earthed structure, a lightning rod may be installed above the antenna to provide shielding.

### 3.2.1 Dipole antenna.

A unity gain dipole is the normal antenna for use on unlicensed channels. As it does not provide any gain, then the power transmitted from the antenna will be the same as the power out of the module, and hence will not exceed the permitted power of the unlicensed channel.

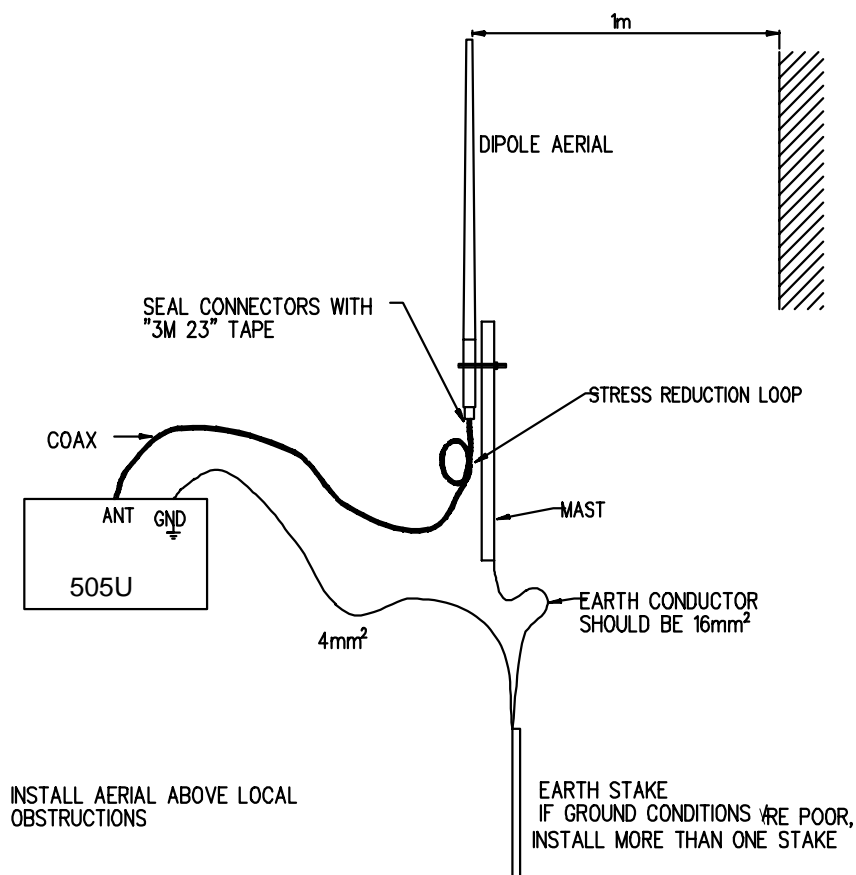

Dipole antennas should be mounted vertically, at least 1 metre away from a wall or mast for maximum performance.

### 3.2.2 Yagi antenna.

Yagi antennas are directional. That is, they have positive gain to the front of the antenna, but negative gain in other directions. This may be used to compensate for coaxial cable loss for installations with marginal radio path.

Yagi antennas should be installed with the central beam horizontal and must be pointed exactly in the direction of transmission to benefit from the gain of the antenna. Also note that Yagi antennas normally have a drain hole on the folded element - the drain hole should be located on the bottom of the installed antenna.

The Yagi antennas may be installed with the elements in a vertical plane (vertically polarised) or in a horizontal plane (horizontally polarised). For a two station installation, with both modules using Yagi antennas, horizontal polarisation is recommended. If there are more than two stations transmitting to a common station, then the Yagi antennas should have vertical polarisation, and the common (or "central" station should have a dipole or collinear (non-directional) antenna.

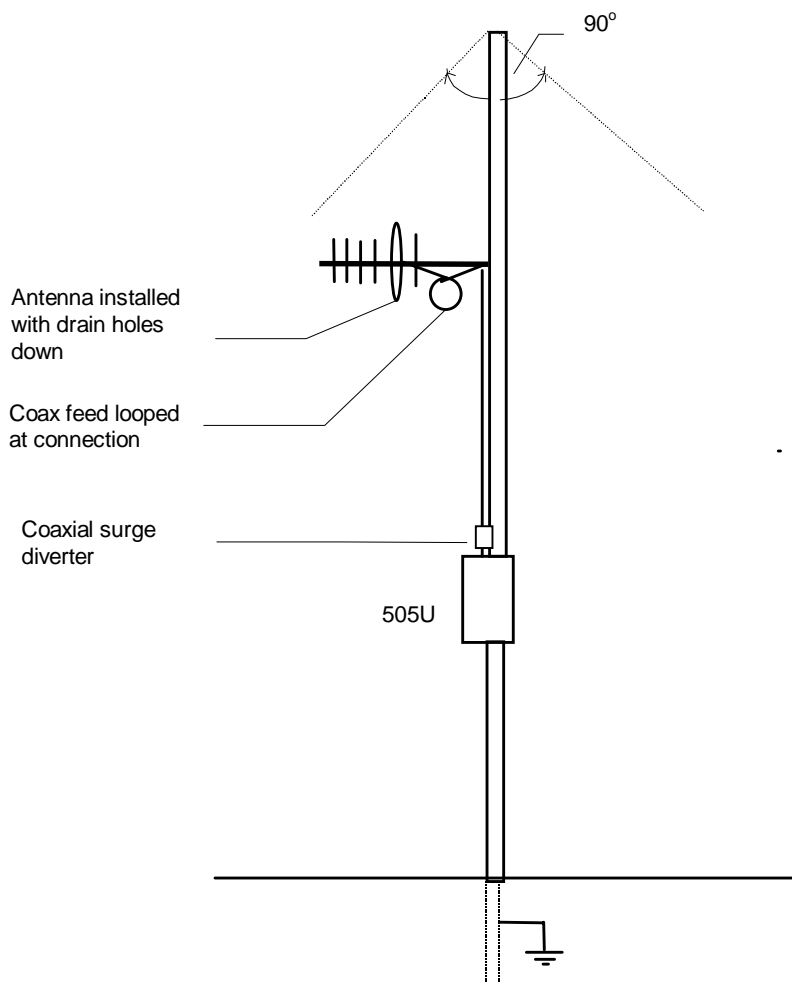



### 3.2.3 Collinear antenna.

A collinear antenna may be used in the same way as a 3 element Yagi to compensate for the losses in long lengths of coaxial cable. This type of antenna is generally used at a central site with more than one remote site or at a repeater site. The collinear antenna looks similar to the dipole, except that it is longer.

### 3.3 Connection Plug

External power and input signals are connected using a 7-pin weatherproof plug, provided with the module. The plug needs to be assembled as per the following diagram.

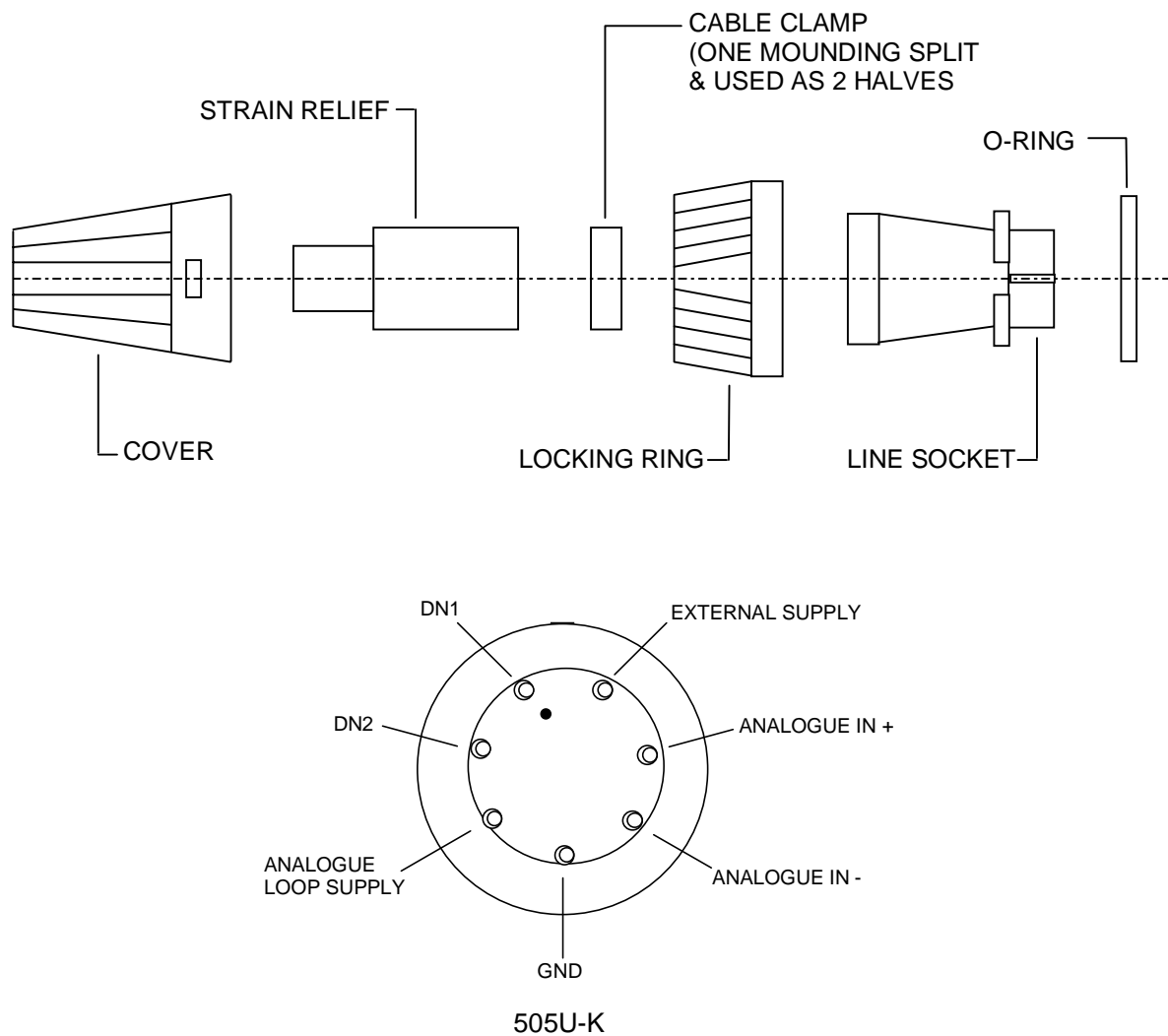

**NOTE: VIEW FROM SOLDER CONNECTION SIDE OF PLUG**

External supply connection is not required when using the BU-5 battery pack.

*For additional protection, we recommend that the plug is wrapped with waterproofing tape.*

### 3.3.1 PL1-K Plug Lead

The PL1-K plug lead assembly is a 1 metre cable pre-terminated to the connector plug. The connector connections are:

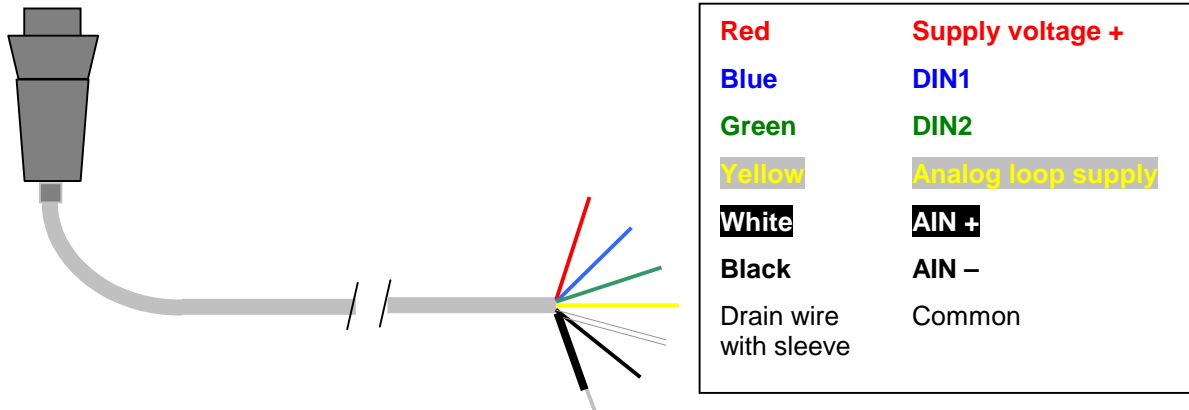

### 3.4 Power Supply

#### 3.4.1 Battery Pack BU-5

The BU-5 can be installed underneath the 505K or beside it. The BU-5 uses the same type of enclosure as the 505K and is mounted in the same way. The BU-5 has a “cable tail” which plugs into the 505K. The input wiring is then connected to a socket on the BU-5.

The lid of the BU-5 can be rotated to suit installation.

A second BU-5 can be connected to the first in a similar manner. The input wiring for the 505K is then connected to the socket on the second BU-5.

*All plugs and connectors should be waterproofed with waterproofing tape.*

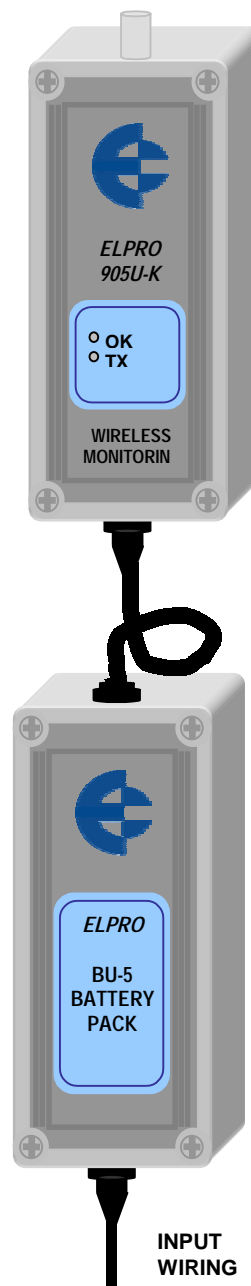
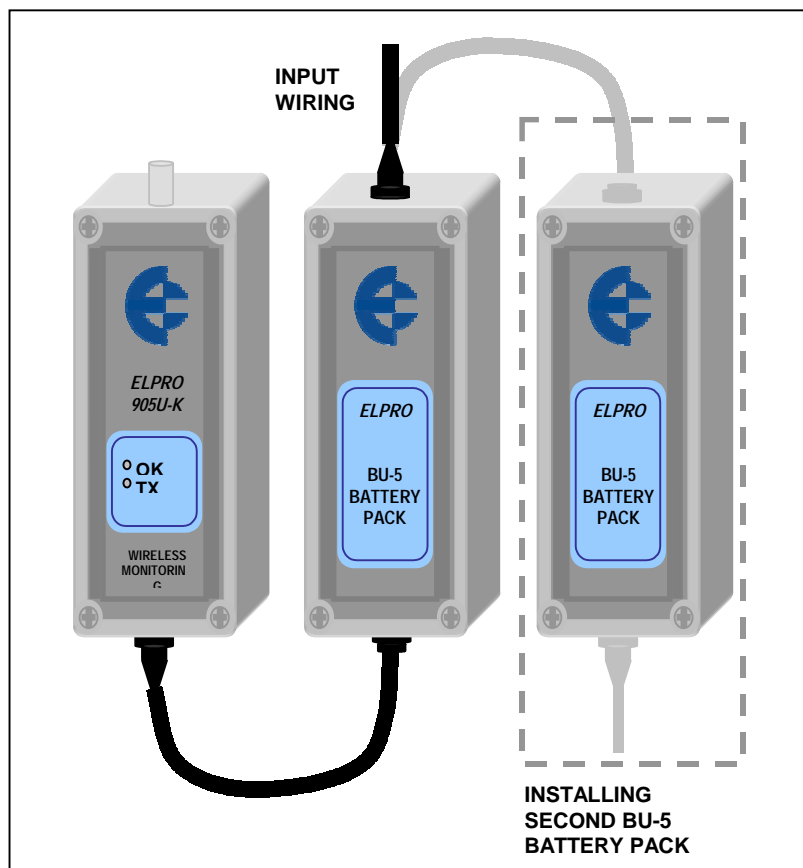

Check the label on the back of the BU-5 to make sure that it has been factory-set to 9V.

The BU-5 takes six alkaline AA batteries - such as Duracel MX1500 or Eveready E91. Do not use rechargeable batteries in the BU-5 as their self discharge life is short. The temperature rating of the BU-5 depends on the battery type - for alkaline batteries, this is

typically -10 to 50 degC. Special “industrial” batteries, such as Eveready EN91, have a wider temperature range, -30 to 55 degC.

Operation of the 505K will stop during battery change, however configuration of the module will **not be lost** when batteries are removed, so no special procedure is required when changing batteries.

Batteries should be inserted as per the drawing - with the BU-5 aligned such that the cable comes out of the top of the module.

The BU-5 can be mounted in any direction. The enclosure lid can be rotated.

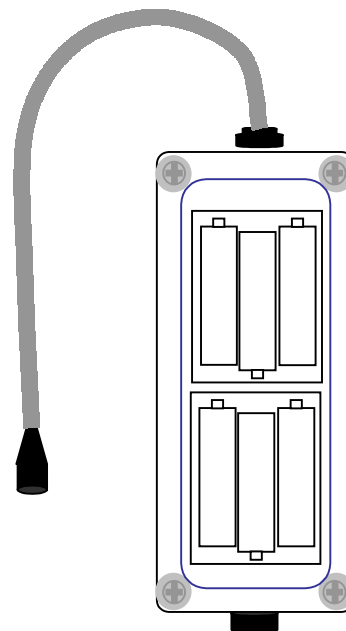

### 3.4.2 External Power

The 505K module will accept an external supply of 6 - 30 volts DC. An external supply with a battery and battery charger is suitable. Negatively grounded or floating supplies are acceptable, however **positively grounded supplies must not be connected**. The 505K connects the negative supply (COMMON) to “ground”. Connect the external supply as per the following diagram.

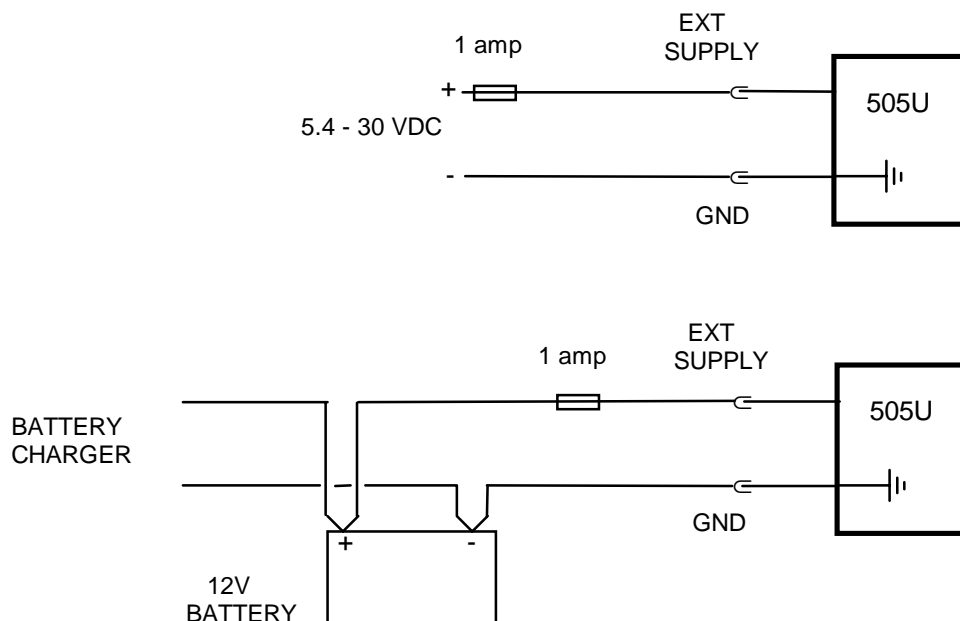

## 3.5 Input Signal Connections

### 3.5.1 Digital/Pulse Inputs

Digital and pulse inputs share the same input channel. Each input is connected between the

DIN connector and COMMON. Inputs can be voltage-free contacts, NPN transistor switches, or a TTL voltage signal (ON < 1.5 volt DC, OFF > 3.5 volts DC).

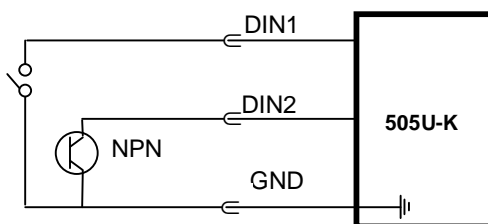

**Inputs can be voltage free contact or open-collector transistor**

Inputs do not have any surge protection. If the sensor or switch is mounted a long way from the 505K module, external isolation such as a relay may be required for surge protection.

### 3.5.2 Shaft Encoder Connections

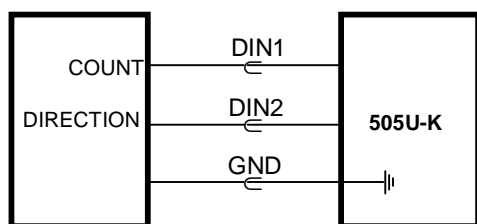

**INCREMENTAL SHAFT ENCODER**

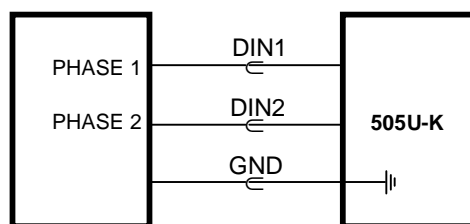

**QUADRATURE SHAFT ENCODER**

### 3.5.3 Analogue input

The analogue input has a positive and a negative terminal, and may be placed at any point in the current loop, as long as neither input rises more than 27V above COMMON or ground. An internal DC/DC converter provides 24 VDC 50mA supply for powering analogue loops .

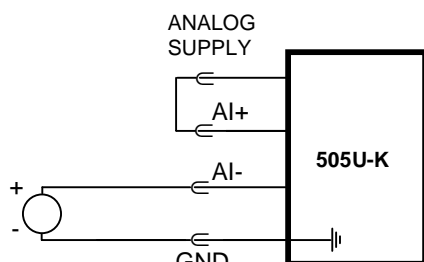

**LOOP POWERED TRANSDUCER**

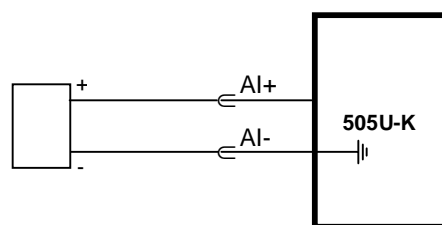

**EXTERNALLY POWERED TRANSDUCER**

Shielded cable is recommended for analogue input loops to minimise induced noise and radio frequency interference (RFI). The shield of the cable must be connected to earth at one end of the cable only. Each input has a loop resistance of 150Ω and zener diode protection against overvoltage and reverse voltage. Additional surge protection is recommended in high

electrical noise environments, or if the analogue signal cable runs for a long distance underground before connecting to the 505K module.

### Voltage Input

Voltage inputs are connected to the AI+ and AI- connections. The maximum voltage signal that can be measured is 10V.

The analogue signal is set up for a 4-20mA signal in the factory. To use a voltage input, change the jumpers inside the module:

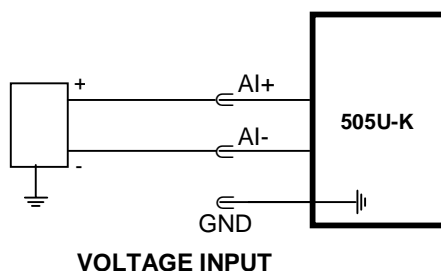

1. Remove the lid from the unit.
2. With the unit oriented with the antenna connector at the top of the unit, locate a set of selector jumpers at the bottom right corner of the box.
3. Using long-nose pliers, remove the two jumpers bridging the left-hand and middle pins, and insert the jumpers between the middle and right-hand pins. When the jumpers are on the left side, the analogue input is set for a mA signal; when on the right side, it is set for a voltage signal.

Shielded cable is recommended for both mA and voltage analog input loops to minimise induced noise and radio frequency interference (RFI). The shield of the cable must be connected to earth at one end of the cable only. Additional surge protection is recommended in high electrical noise environments, or if the analog signal cable runs for a long distance underground before connecting to the 905K module.

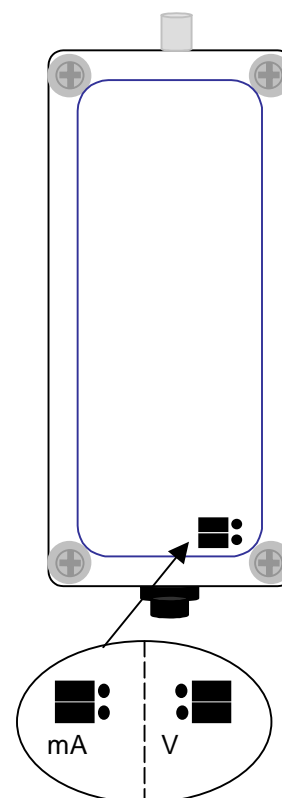

### 3.5.4 RS232 serial port

An RS232 port is provided for connection of a PC for configuration and diagnostics. To access the serial port DB9 connector, remove the front cover from the module by unscrewing the four screws in the front panel. The serial port is a 9 pin DB9 male and provides for connection to a terminal or to a PC for configuration, field testing and for factory testing.

Communication is via standard RS-232 signals. The 505K is configured as DCE equipment with the pinout detailed below.

Pin	Name	Dirn	Function
1	-	-	Not Used.
2	RD	Out	Receive Data - Serial Data Output (High = 0, Low = 1)
3	TD	In	Transmit Data - Serial Data Input (High = 0, Low = 1)
4	DTR	In	Data Terminal Ready - used by 505K as a "wake-up" signal
5	SG	-	Signal Ground
6	-	-	Not Used.
7	-	-	Not Used.
8	-	-	Not Used.
9	-	-	Not Used.

**The DTR signal must be connected to the 505K** to enable communications and “wake up” the microprocessor. This means that the DTR wire must be connected - the PC does not need to control DTR. When communications is established, the green LED will light continuously.

The serial port communicates at a baud rate of 9600 baud, 8 bits, no parity, one stop bit.

An example cable drawing for connection to a personal computer is detailed below:

E505 DB9 (M) Connector

Computer DB9 (F) Connector



## 4 CONFIGURATION

The 505K module is configured by creating a configuration file on a PC and downloading to the 505K via the RS232 serial port. You will require the configuration software, and a serial cable - refer to the previous section for details on the cable.

The configuration software is supplied as "free-ware" on the Product Catalog CD supplied with each order. The configuration software for the 505K is the same as the software for the 105U. Please read section 4.3 of the 105U User Manual before proceeding further.

Setup the project name and system address as per the 105U manual. Enter the "units" as per the manual. Select "505-K" as the unit type for 505K modules.

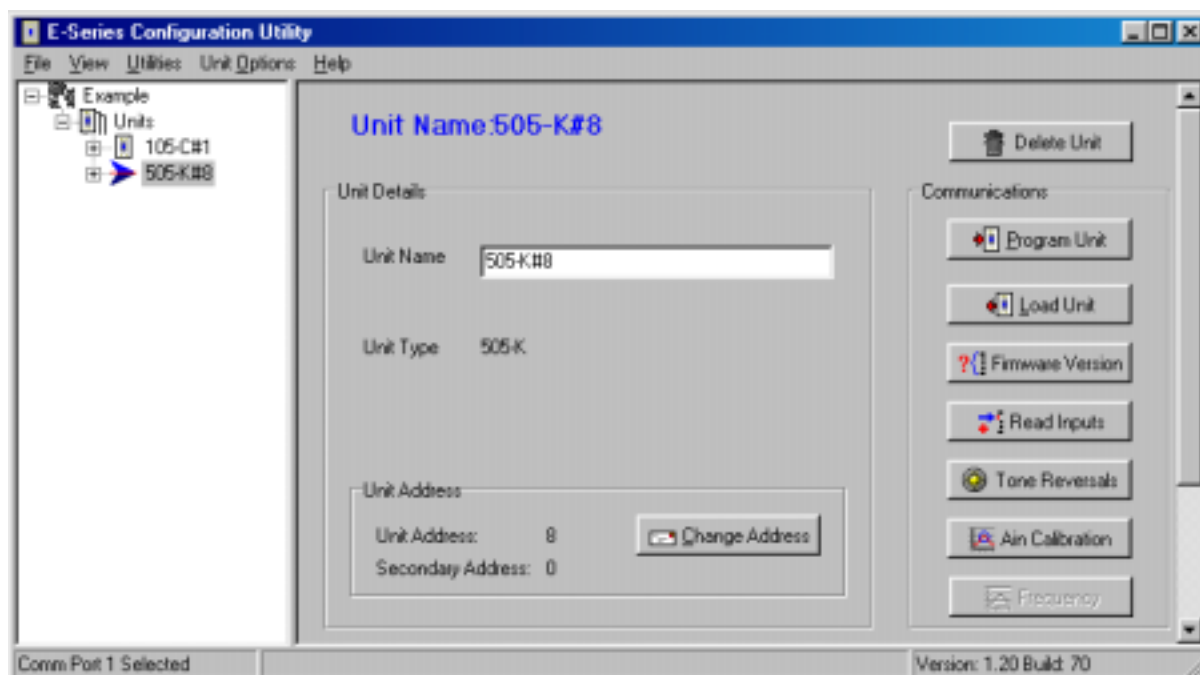

Each 505K has a unit address and a secondary address - 105U modules only have a unit address, they do not use a secondary address. Up to eight 505K modules can use the same unit address. This allows a large number of 505U modules to be used in a system. If you enter the same unit address for more than one 505K, the configuration software will automatically increase the secondary address. In the example above, 505-K#8 is the first module configured with unit address 8 - its secondary address is 0. If a second 505K module is configured with unit address 8, it will appear as 505-K#8\_1 - its secondary address is 1. Note that this module is recognised as a completely different module to the first 505K.

For small systems, it is simpler to select a unique unit address for each 505K module.



### 4.1 I/O Mapping

Enter I/O mappings as per the 105U manual.

In the following example, a digital input at a 505K is mapped to DO1 of 105U#13. The analogue input of the 505K is mapped to AO2 of the same module.

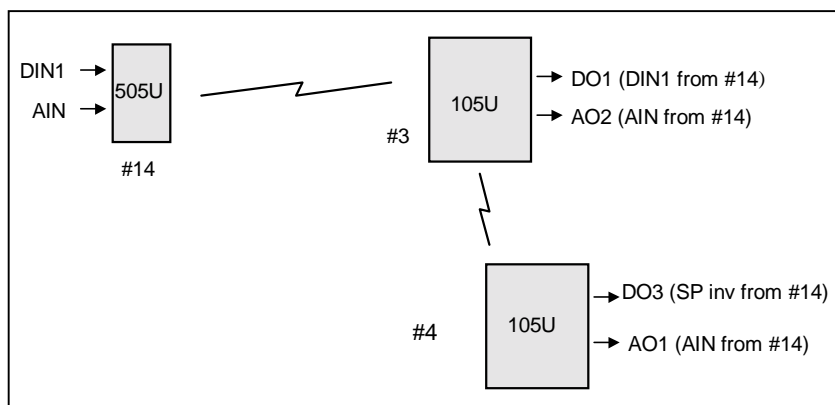

The setpoint status of the 505K is mapped (inverted) to DO3 of 105U#14, using 105U#13 as a repeater. The 505K AI is also mapped to AO1 of this module. That is, the AI is mapped twice.

The mapping configuration for the 505K would be :

The screenshot shows the 'E-Series Configuration Utility' window. On the left is a tree view with 'Units' expanded to show '105-1#3', '105-1#4', and '505-K#14'. The 'Mappings' section is active. The main table displays the following configuration:

Inv	Input	Dest Unit	Output	Rep'ter 1	R...	F
N	DIN1	105-1#3	DOT1			
N	AIN1	105-1#3	AOT2			
Y	SETPOINT1	105-1#4	DOT3	105-1#3		
N	AIN1	105-1#4	AOT1	105-1#3		

The 'Mapping Configuration' dialog box is open, showing the following details:

- Source Unit: 505-K#14
- From Input: Setpoint 1
- To Destination: 105-1#4
- At Output: Digital Output 3
- Invert Input
- Originating ID: Setpoint 1
- Destination Unit: 105-1#4
- Destination ID: Digital Output 3
- Via Repeaters: 1: 105-1#3, 2: None, 3: None, 4: None, 5: None

## 4.2 Update Transmission Times

Each input signal has an update time. If a change has not occurred for this input within this time, then a transmission is set for this input after the update time has expired. Each input signal has its own timer - when a transmission occurs for this input (either a change transmission or an update transmission) the timer is reset to zero. If the timer reaches the Update Time value, then a update transmission occurs.

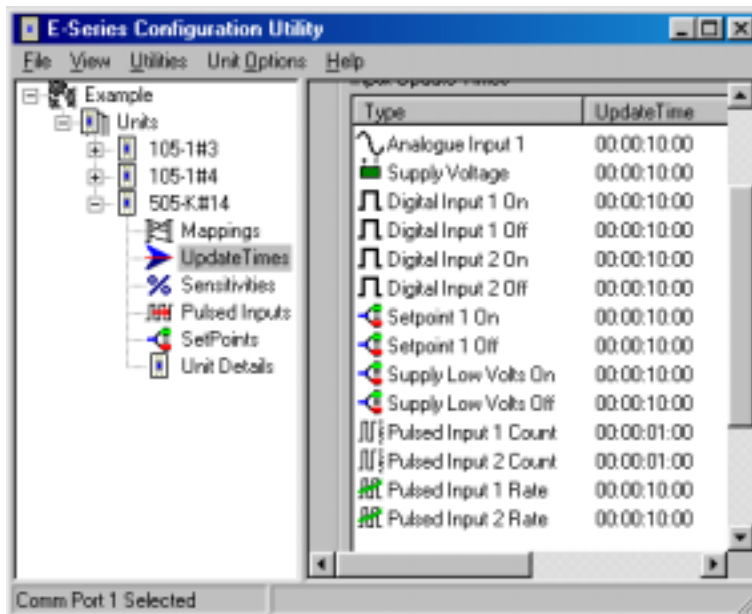

Digital inputs (both external inputs and internal) have a separate update time for their "off" state and "on" state. This allows the input to be reported differently depending on its state. If the digital input is an alarm, then a user may wish the input to be updated more frequently when in the alarm state than when not in the alarm state.

The analogue input and pulsed inputs only have one update time value.

Valid values are 10 seconds to 7days. If less than 10 seconds is entered, the value will default to "disabled". If "disabled" is selected, then there will be no updates for this input.

## 4.3 Digital Inputs

Apart from update times, the only configurable parameter for digital inputs is the paralysis time. This parameter can be changed by selecting the Unit details option.

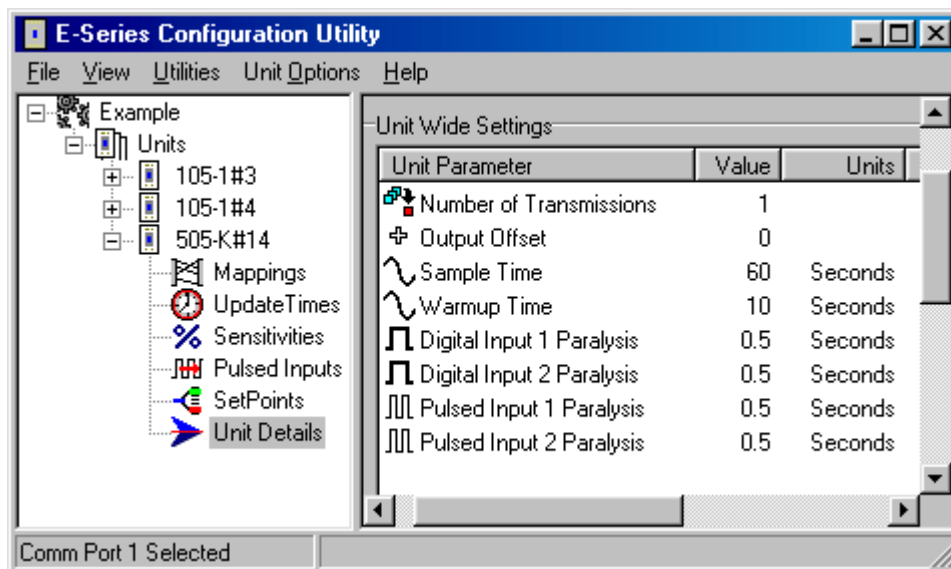

If a value of zero is entered, then there is no paralysis time.

The default value is 0.5 sec and will cover most applications.

A paralysis time is useful in large systems when a lot of inputs can change at the same time. Once a 505K has transmitted a message, it cannot transmit another message during the paralysis time - this is to prevent overcrowding of the radio channel. An example could be a system monitoring environmental alarms. Normally there would be few change messages, but under abnormal conditions, a lot of change messages could be generated in a short time period. The paralysis time will allow each module to send the first change message, but subsequent change messages are disabled during the paralysis time.

There is a separate paralysis time for digital change messages and pulse change messages. There is no paralysis time for analogue inputs.

#### 4.4 Analogue Input

There are three parameters which may be adjusted for the analogue input.

The **change sensitivity** is the amount of change since the last transmission which will trigger another transmission for this input. For example, if the last transmitted value of the input was

55.0%, and the sensitivity is 1.2%, then another transmission will occur if the measured input value is less than 53.8% or more than 56.2%. If change messages are not required, then a sensitivity of 75% should be selected.

The 505K does not have any filtering on the analogue measurement. If the analogue signal is noisy, then a lot of change messages can be generated if the sensitivity value is set too low. The sensitivity should be set to be greater than the signal noise. For example, if there is a signal oscillation of 1% on the input, then a sensitivity of less than 1% will result in continuous change transmissions which could overload the radio channel.

The **sample time** is the time period for each analogue input measurement. Between measurements, the 505K will operate in "sleep" mode. When the sample time has expired, the 505K will turn on the analogue loop power supply. After a further time, called the **warmup time**, the 505K will make a measurement of the input. The warmup time allows the transducer to stabilise and become accurate after the loop supply is turned on.

The sample time may be entered in seconds, between 0 and 32 767 seconds. The warm-up time may be entered in seconds between 0 and 100 seconds.

If the sample time is less than or equal to the warm-up time, then the analogue loop supply will be always on and measurements of the analogue signal will be taken based on the sample

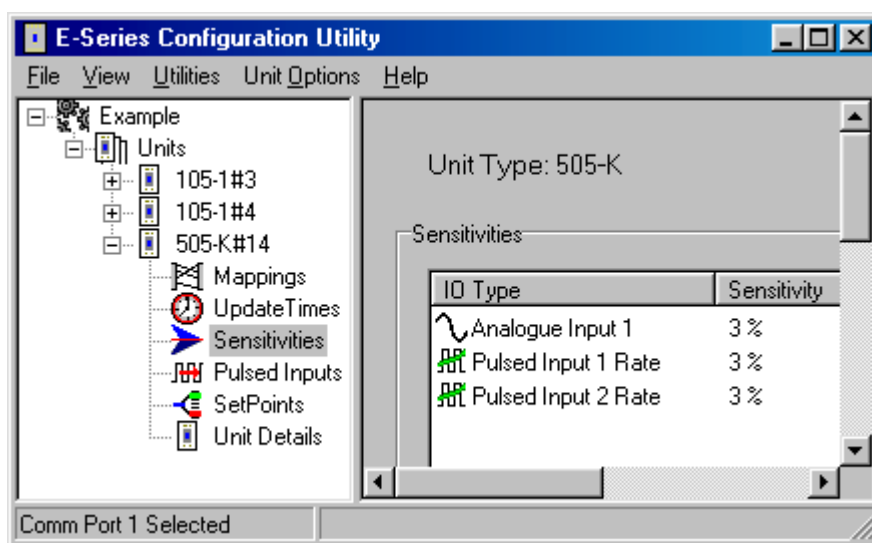

time. If the sample time is zero, then a measurement will be taken every 0.5 sec.

The analogue loop supply will be always on, so this situation is not suitable for a battery power supply.

Consider the above example, with 505K #14. This module is mounted on a water tank, and the analogue input is a level transducer. The 505K is powered by a BU-5 battery pack and to conserve power, a measurement is taken every 30 minutes (1800 sec). The transducer requires a warm-up time of 7 seconds to achieve accuracy, so a value of 10 seconds is chosen.

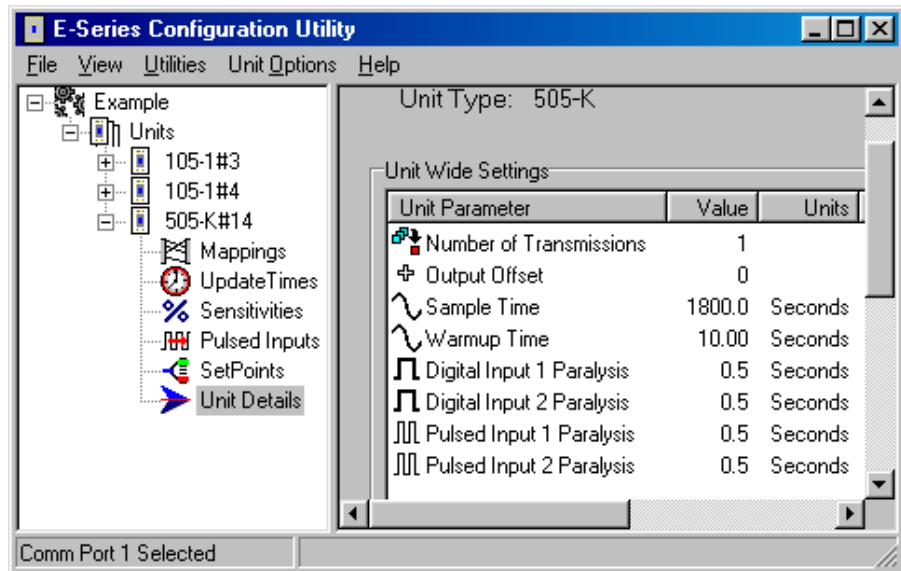

In another application involving the continuous monitoring of pressure in a pipeline, values of zero are chosen for the sample time and warm-up time. The analogue loop will be continuously active and a measurement is taken every 0.5 sec. Because occasional pressure fluctuations caused a lot of transmissions, then the sample time value was increased to 5 seconds, and a measurement was taken every 5 sec. Because the warm-up time is still zero, the analogue loop is continuously active.

### 4.5 Analogue Setpoints

A high setpoint value and a low setpoint value may be entered. The internal setpoint status is determined by these values in comparison to the analogue input value. If the analogue input is less than the low setpoint, then the setpoint status is "on". If the analogue input is more

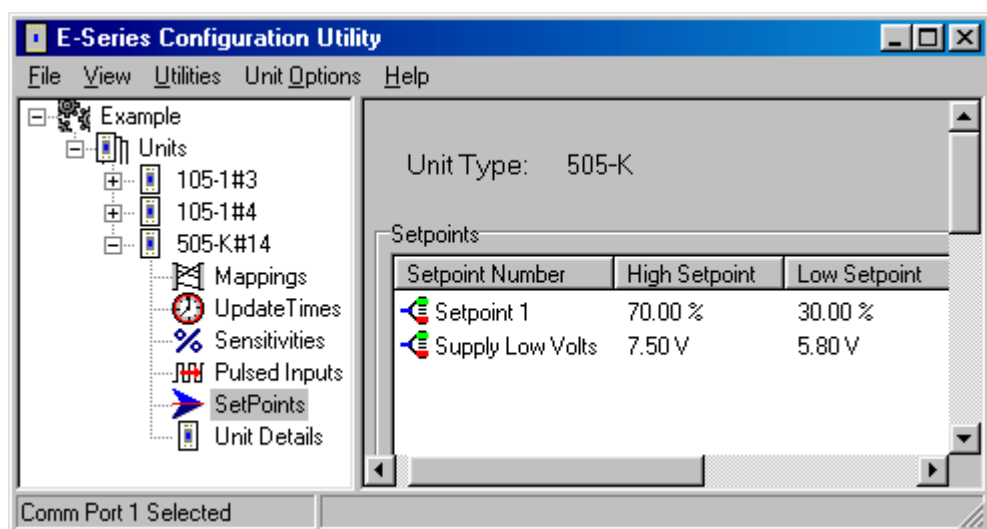

than the high setpoint, then the setpoint status is "off". When the input is between the low and high setpoints, then the setpoint status remains unchanged.

The setpoint values may be set between 0 and 100% of the calibrated range. The low setpoint may be set to the same value as the high setpoint, however the low setpoint should not be set to a higher value than the high setpoint.

#### 4.6 Supply Voltage

The supply voltage may be mapped as an internal analogue input. The 16 bit value corresponds to 0-30V. There is no analogue sensitivity for this measurement - it is only transmitted based on the configured update time. The measurement is taken every time the 505K transmitter operates.

The supply voltage also has user-configurable setpoints to determine the Supply Low Volts alarm. These setpoints can be set from the SetPoint option. The 905K module will shut-down when the supply voltage reaches 90% of the "low volts" value. We recommend the following setpoint values:

<b>Battery Type</b>	<b>Low Volts Setpoint</b>	<b>Shut-down Voltage</b>
BU-5 Battery Pack	6.0	5.4
12V "Gell-cell"	11.2	10.0

## 4.7 Pulse Inputs

Each 505K has two pulse inputs. Each pulse input has 2 x 16 bit counters and a calculated pulse rate value. The 2 x 16 bit counters are a base counter which increments on each pulse, and an “HI” counter which increments each time the base counter overflows. Either or both counters can be transmitted, although each is transmitted individually.

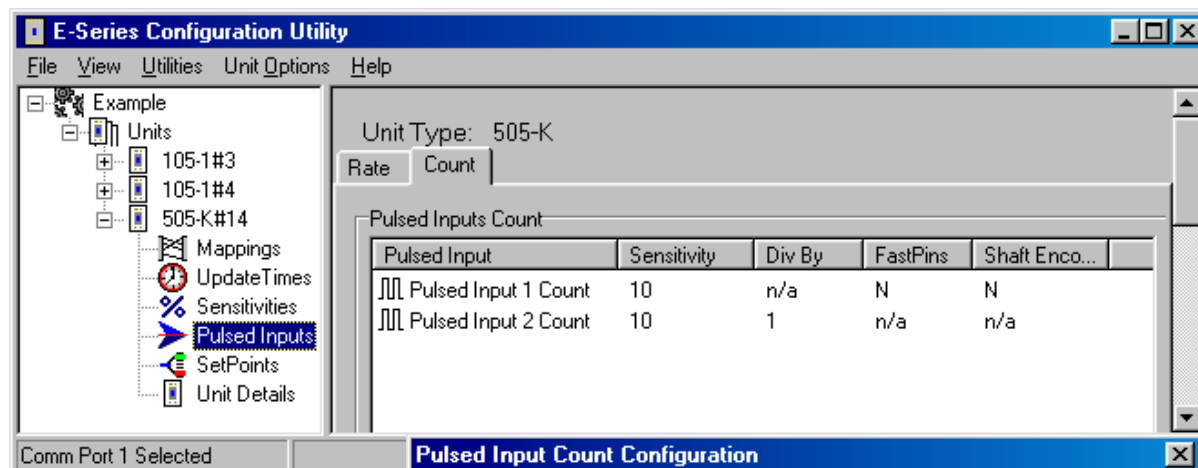

There are several configurable parameters for pulse inputs. The paralysis value can be adjusted from the Unit Details selection, as per Digital Inputs.

The pulse inputs also have a Sensitivity value. The pulse input sensitivity is the number of pulse increments since the last transmission to

trigger another transmission. For example, if the pulse count at the last transmission for a pulse input was 1000, and the sensitivity value is 10, then another transmission will occur when the pulse count reaches 1010 (provided there has not been an update transmission during this period). The sensitivity values can be between 1 and 32000.

If either pulse input has an input rate of more than 10Hz, then the Fast Pulse Input option should be selected from the Pulsed Inputs selection. This is selected at “Pulse Input 1 Count” even if you are using PI2. That is, if either PI1 or PI2 is faster than 10Hz, select “Enable Fast Pulse Inputs” for PI1. Selecting Fast PI will increase the power consumption of the 505K and is not suitable for battery supplies.

PI2 has a user-configurable divider for scaling its pulse counters. PI1 does not have a divider. The PI2 divider can be an integer from 1 – 255. If the divider is set to X, then the base counter will increment by 1 for every X input pulses.

Example 1:

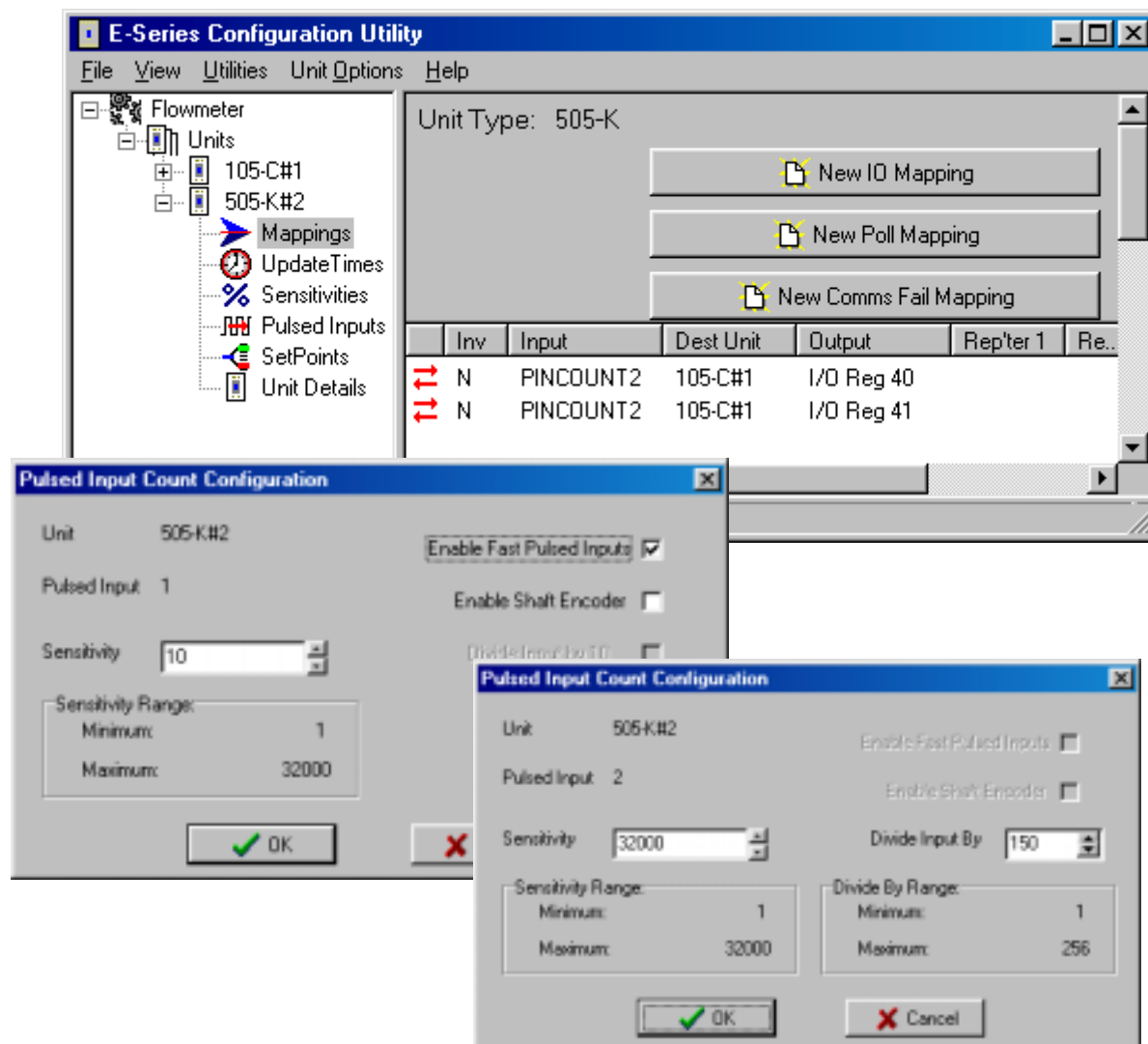

A turbine meter is connected to a 505K with a pulse signal of 15 pulses per 100 litres. The normal flow rate is 300 l/sec - that is, the normal pulse signal is 45Hz (15/100x300). Each Kilolitre (Kl) corresponds to 150 pulses.

The flow signal is connected to PI2, and divider of 150 is selected such that the pulse count is scaled to units of Kl. Both PI2 counters are transmitted to a 105C module for interfacing to a HMI package. The HMI will read both counter values and calculate a 32 bit totalized flow value.

Example 2:

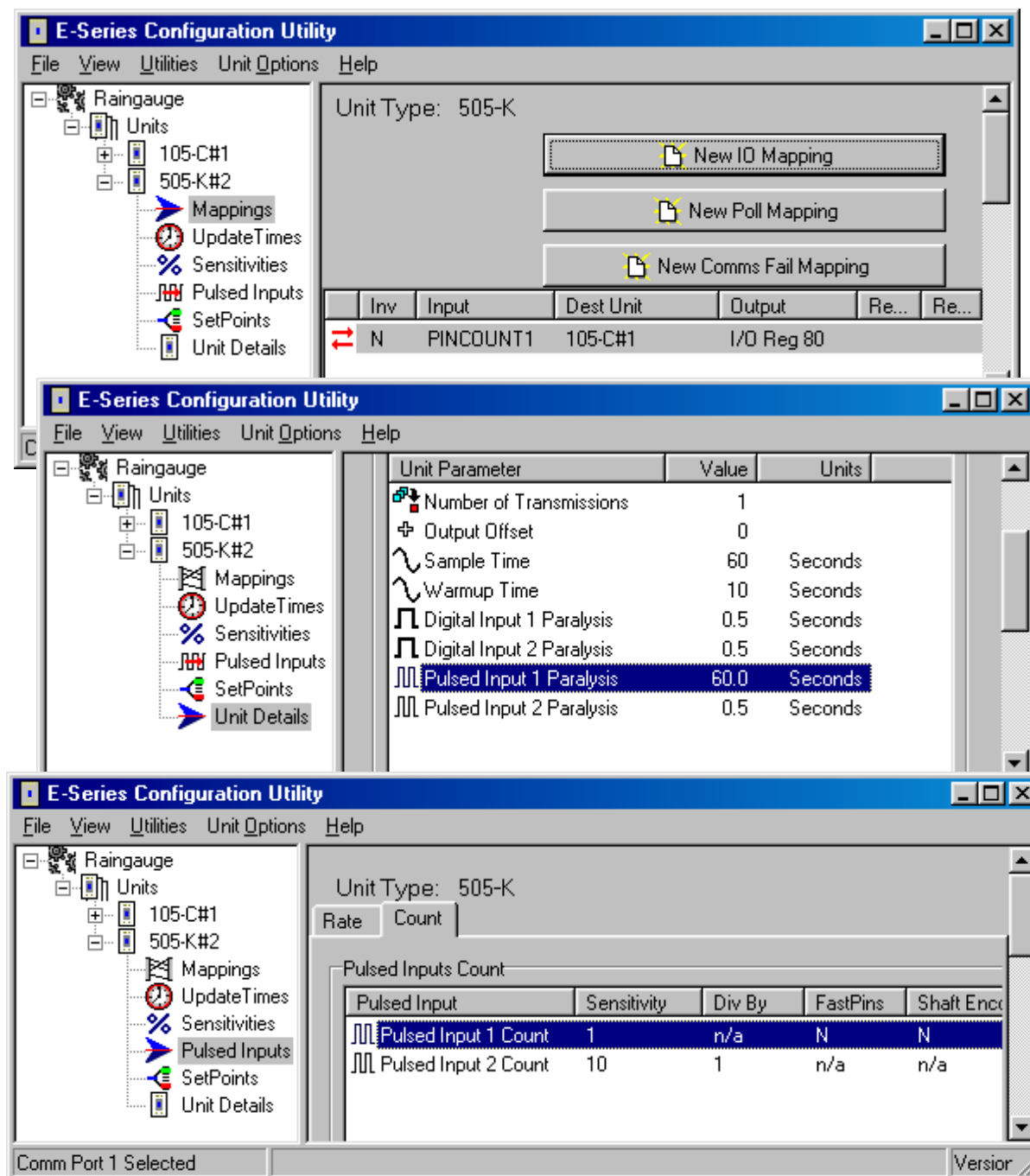

A system of tipping bucket raingauges is installed to monitor rainfall in a catchment area. Each rain gauge provides a pulse signal to a 505K - each pulse represents 0.2mm of rain.

The user wants a transmission at each pulse. During dry periods or periods of light rain, the number of transmissions are small - but during periods of heavy rain, there could be a pulse every couple of seconds - because of the large number of raingauges, this could result in jamming of the radio channel. To prevent this occurring, a paralysis time of 60 seconds is selected.



### 4.7.1 Manually Setting Counter Values

The values in the counters can be manually set to any value - refer to section 5.3.2 of this manual.

### 4.7.2 Shaft Encoder Inputs

If the pulse inputs are connected to a shaft encoder (incremental or quadrature types), then the Shaft Encoder Inputs option should be selected. The 505K will then look at both pulse input signals and calculate a “position” value for the shaft encoder.

If an incremental encoder is used, then the correct counter value will be stored in the PI1 counter. If a quadrature encoder is used, the value will be stored in the PI2 counter. Note that you don’t need to select which type of encoder is used. The 505K will calculate both values. Only the base counters should be used; do not use the Hi or overflow counters.

If the pulse rate from the encoder is greater than 10Hz, then Fast Pulse Inputs should be selected as for normal pulse inputs. The scaling divider for PI2 must be set to 1.

To physically set up the shaft encoder, set the shaft encoder to the middle of the range, then manually set the counter value to the value required (refer section 5.3.2). As the encoder moves up and down, the counter value will increase or decrease.

### 4.7.3 Pulse Rates

The 505K calculates the rate of the pulse inputs and makes these values available to be mapped as internal analogue inputs. For PI2, the pulse rate is calculated on the scaled counter - that is, after the input is divided. The maximum

rate that can be calculated for both inputs is 1000Hz.

The maximum value of the pulse rate is user-configurable. That is, you select the maximum rate that corresponds to 100% of the analogue

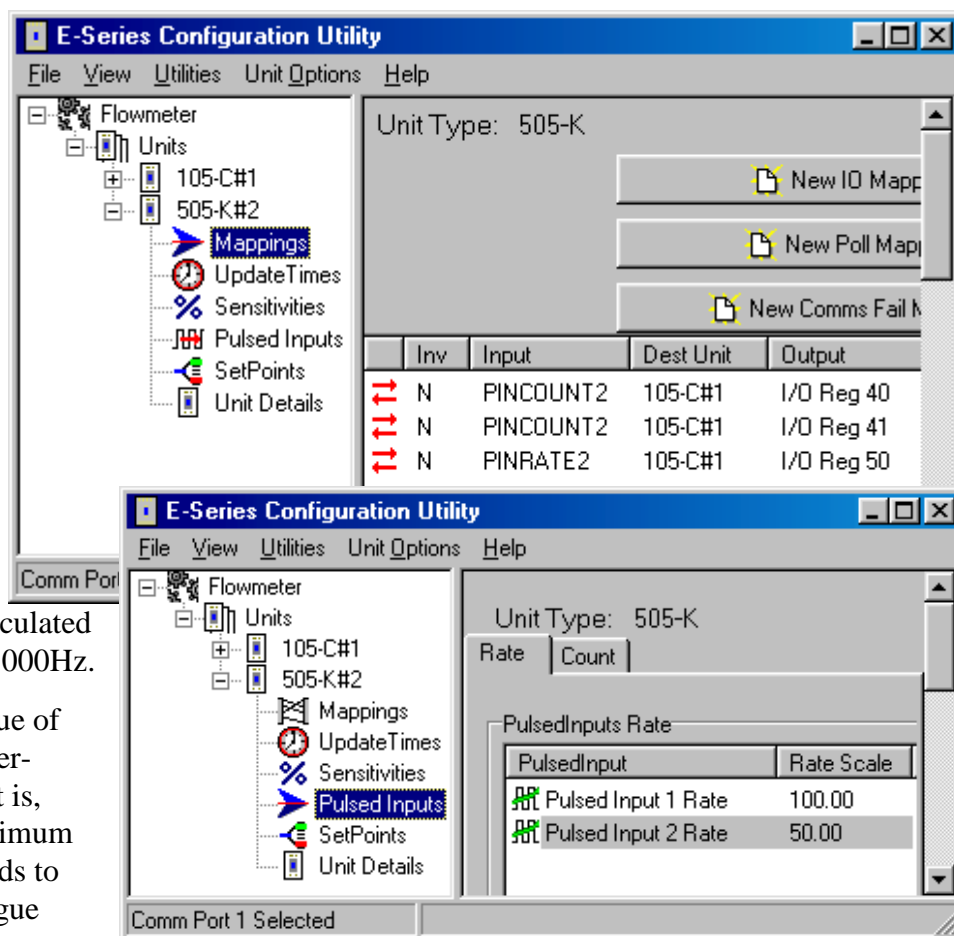

value. For example, if the normal pulse rate is 35Hz, you may decide that the maximum signal should be 50Hz. The 505K will then transmit 100% value at 50Hz. The maximum pulse rate can be configured from 0.02 Hz to 1000Hz.

For shaft encoder inputs, you can use PR1 for incremental encoders and PR2 for quadrature encoders. The rate signal will be 50% for 0 Hz, between 50 – 100% when the encoder is increasing and 0 – 50% when the encoder is decreasing. If you configure the maximum pulse rate to be X Hz, then the analog value will be 100% at X Hz increasing, and 0% value at X Hz decreasing.

#### 4.8 Number of Transmissions

This parameter allows you to select the number of transmissions for each message. For example, if 3 is selected, then each message will be transmitted three times. The time between each transmission will be a random time between 0.5 and 4 seconds. The valid choices for this option are 1 - 5.

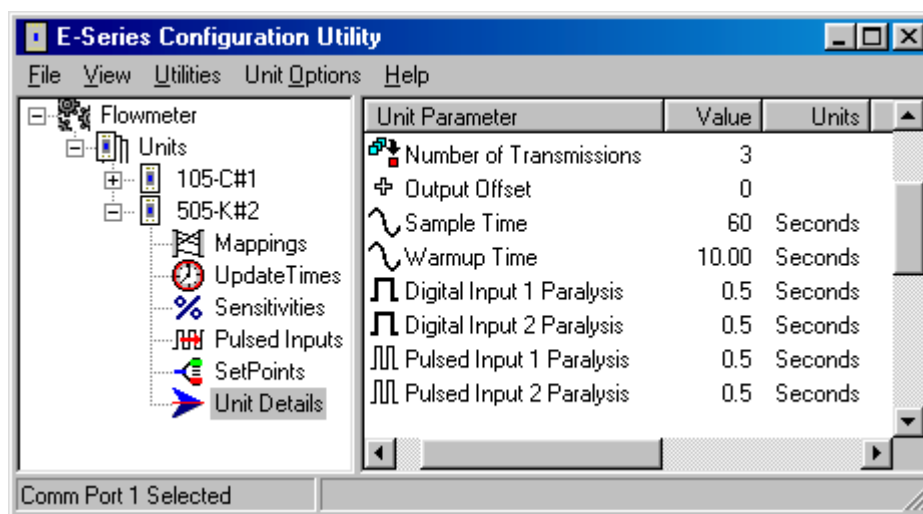

#### 4.9 Programming Configuration from to Module

To programme a module :

- Connect the cable from the PC's serial port to the 505K serial port (see 3.5.4 for cable connections)
- From the Utilities menu, select "Serial Port Setup"
- Select the appropriate serial port (COM1 - COM4)
- Select the unit to be configured from the left-hand menu
- Click on the "Program Unit" button.

You will be asked to confirm if the module already has a different system or unit address.

Each module will need to be programmed individually.

#### 4.10 Loading Configuration from a Module

Care should be taken when loading a configuration from a module. It is easy to lose the

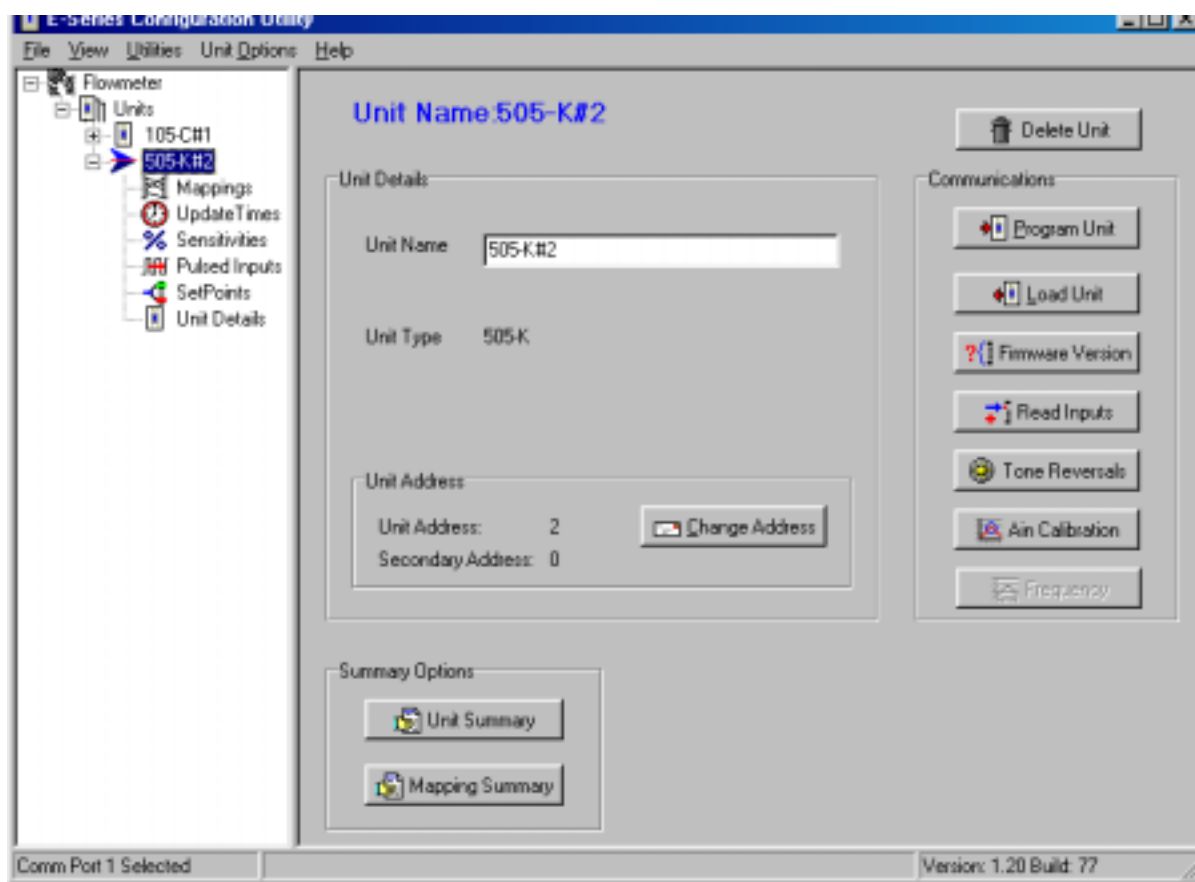

system address and unit address. We suggest that you first view the system address and unit address - you can do this via the “Unit Options” menu. Note these addresses before loading the configuration.

When you upload the configuration, the program will check if you want to load the addresses from the module. If you do not, then the system address and unit address will change.

#### 4.11 Print Options

You can obtain a print-out of each module configuration. On each unit display, there are “Unit Summary” and “Mapping Summary” windows. Each of these will display a printable information page about that module. The Unit Summary page will display the user options configured, and the Mapping Summary will display the mappings entered for that unit.

The printer may be selected from the Printer Setup option in the File menu.

---

## 5 DIAGNOSTICS AND TESTING

### 5.1 System Problems

Most problems relate to incorrect configuration, or radio path problems. Before installing the 505K module, "bench-test" its operation with the receiving 905U module alongside. If the 505K does not work properly in this test, it will not work properly installed. If problems are found, check the configuration.

If the bench-test is successful, however problems are experienced after installation, check the radio path (refer to the 105U User Manual for radio path testing).

The 505K provides the following diagnostic features which will help to identify problems.

### 5.2 LED Indicators

Normally the green OK LED on the front panel will flash briefly every 10 seconds. When the OK LED extinguishes a sleepmode state is indicated conserving the 505K's battery power. If the OK LED does not flash, a flat battery condition or an internal failure may exist. If the 505K module is located outside, then it will be difficult to see when the LED indicators are on. Remove the front lid of the 505K to see the LED's better.

The yellow TX LED will flash whenever a radio transmission occurs.

#### Table of indicator conditions

INDICATOR	CONDITION	MEANING
OK LED ON	Flashes briefly	Normal Operation
OK LED OFF	Continuously	Supply fail or Battery voltage low CPU failure
OK LED ON	Continuously	Analogue loop on Configuration cable connected
TX LED ON	Flashes briefly	Radio transmitting

### 5.3 Diagnostic Features

The configuration software provides some diagnostic features to help identify problems. To use these features, connect the 905K to a PC using a RS232 cable and run the configuration software. The OK LED will light continuously once the module is in configuration mode.

*Note : The OK LED will generally not light continuously unless the cable is in place and the configuration software is running.*



### 5.3.1 Read Inputs

This option provides a display of the measured input signals in the 505K, both internal and external. Digital inputs (internal and external) are displayed as "ON" or "OFF", the pulse input accumulated count values are displayed and the analogue input value is displayed in mA or V.

The displayed values will only update when you select the "Update" box. Note that the analogue input value is only updated when the configured analogue sample occurs.

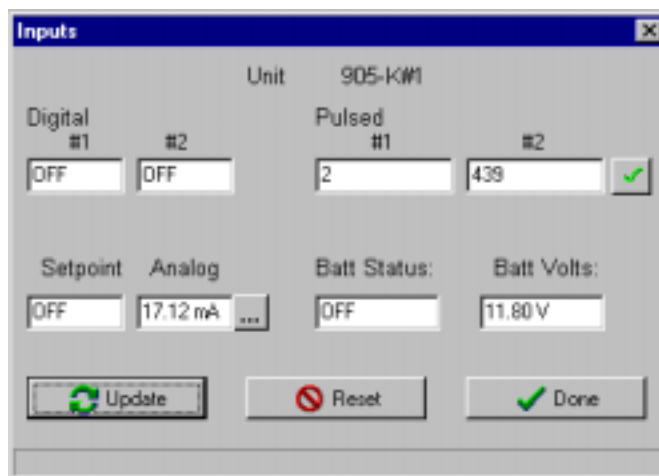

If the analogue display shows mA and you are using a voltage signal, then the analogue input has not been calibrated. Select the "..." box beside the analogue display and follow the procedure in 5.3.3 below.

The counter values will display both base and Hi counters as a 32 bit number, but in "decimal" format. If the counter value is less than 65536, then the Hi or overflow counter is zero.

### 5.3.2 Setting Counter Values

To manually set counter values, highlight the existing counter values and over-type the new

value required. Then select the green “✓” box beside counter #2. The new values will be written into the module.

### 5.3.3 Calibrating Analog Input

The 505K will be calibrated for a 4-20mA signal in the factory. You can calibrate for a different input signal.

1. If you are using a voltage signal, first set the internal “jumpers” as per section 3.5.3
2. Select the “AIN Calibration” box on the main display. The “AIN Range Selection” box will display.
3. If you wish to calibrate to 4-20mA, 0-5V or 0-10V, simply select the range on the left side of the box. If you want another range, enter the low and high values and units on the right side of the box - for example, for 1 – 5 volts, you would enter 1, 5 and V.

If you enter a range on the right side, the left side is ignored. When you have entered the range, select “OK”.

4. The “Analogue Calibration” display will appear. This display allows you to enter user calibration values into the 505K. First, you can check any existing user calibration figures by selecting “Check Calibration” - if there is any existing calibration figures, these will appear.

5. To calibrate the analogue input, connect the analogue signal to the 505K. Adjust the signal to the minimum value (0%). Select “Process Low Value” - the calibration value for this signal will appear.
6. Now adjust the signal to the maximum value (100%). Select “Process High Value”.

7. When you have finished this process, select “Write Configuration” - this will write the configuration values to the user-calibration registers in the 505K. Select “Done” and the analogue signal is calibrated.

The accuracy of the analogue signal can

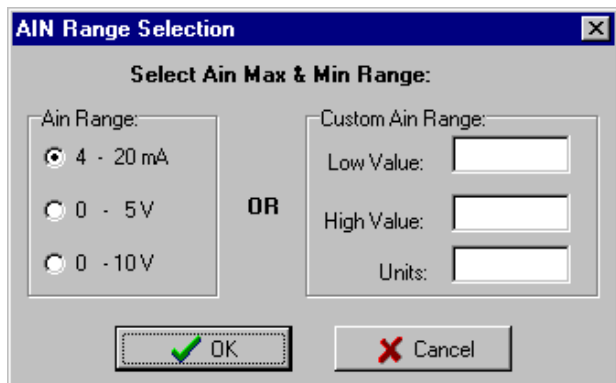
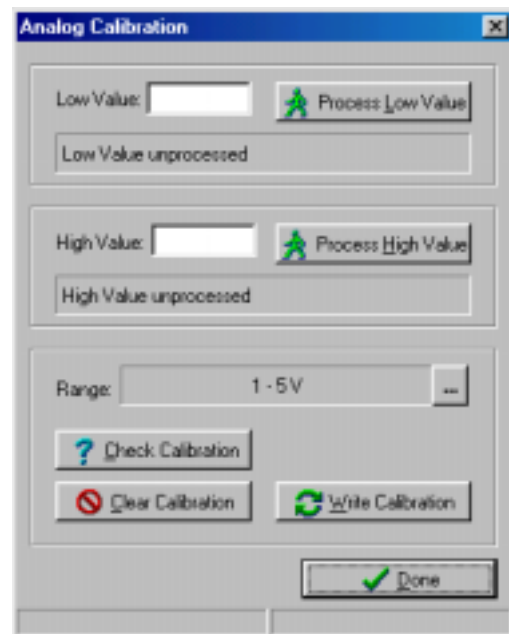
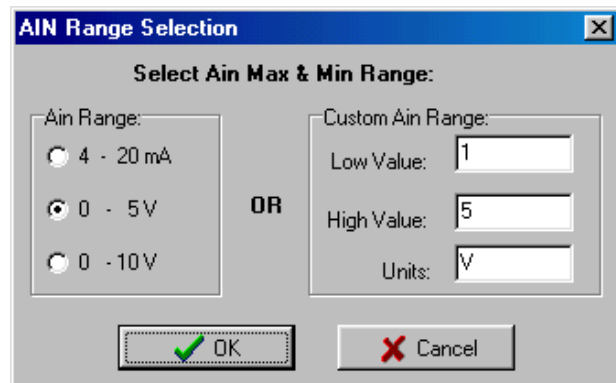

only be as accurate as the calibration. For high accuracy measurement, you will need to use a high accuracy mA or V meter to ensure that the high and low values are correct.

If you wish to return to the factory-calibration, select “4-20mA” at the AIN Range Selection display, then “Clear Calibration” at the “Analogue Calibration” display.

#### **5.3.4 Tone Reversals**

This feature turns the radio transmitter on continuously for radio path testing. A series of 1 and 0 data bits is transmitted. If the 505K is powered from a battery supply, this testing will draw a lot of power.

To do radio path testing, refer to the 105U User Manual.

#### **5.3.5 Firmware Version**

The feature will display the firmware (software) version of the 505K module.

## 6 SPECIFICATIONS

<b>General</b>		
EMC approval	EN 300 683 AS 3548	89/336/EEC
Radio approval	EN-300-220	
Housing	160 x 64 x 36mm IP66	Industrial-grade painted aluminium
I/O & Power Connection	Weatherproof bayonet connector Conxall 6282-7SG-522	Suitable for 0.75 mm <sup>2</sup> conductors Matching female part supplied with unit
LED indication	Transmit Operation OK Configuration mode, Reading analogue	Flash on transmit Flash every 5-10 sec On continuously
Operating Temperature	-40 to 60 degrees C	0 – 99% RH
<b>Power Supply</b>		
	6 - 30 V DC	Overvoltage, reverse power protected
BU-5 Battery Pack (optional)	6 x AA 1.5V alkaline 9V, 1.7 ampour	Duracell MN1500B4 or equiv.

Current Drain	<140 $\mu$ A 10mA + analogue loop current	“Sleep” mode Operating mode
Analogue loop supply	Included	24V DC 50mA
Low voltage status	User-configurable	Can be transmitted to remote modules
<b>Radio Transmitter</b>		
Frequency	869.4 – 869.65 MHz	Fixed frequency
Transmit power	500mW	
Spurious emissions	TX - <-37 dBm	
Frequency Stability	+/- 1.0 kHz	
Expected line-of-sight range	5 km	Range may be extended by using up to 5 intermediate 105U



		modules as repeaters,
Antenna Connector	Female SMA coaxial	
<b>Serial Ports</b>		
RS232 Port	DB9 female DCE	9600 baud, no parity, 8 data bits, 1 stop bit
<b>Inputs</b>		
Digital/Pulse Inputs	2 inputs	Suitable for voltage free contacts, NPN transistor or TTL signal
Pulse Inputs	Transmitted as 2 x 16 bit counters, plus pulse rate value	Share digital inputs. Max rate 300Hz for contact or transistor inputs, 10KHz for TTL inputs (50KHz on PI2 using divider) PI2 has a configurable 1-255 integer divider Max value for pulse rate is 1KHz.
Analogue Input	One 0 - 24 mA, 0 - 10 V Range user-configurable	“floating” differential input, common mode voltage 24V. 24V DC for powering external loops provided, 50 mA max. Resolution 12 bit, Accuracy < 0.1%. Transducer warm-up time configurable 1 - 100 seconds.
Analogue Input Setpoint		Configurable high & low setpoint may be transmitted to remote units, allowing set/reset of remote digital outputs
<b>System Parameters</b>		
Network Configurations	Max. number of 505K inputs is >20 000 if 105U-C modules are used as receivers.	505K is compatible with 105U radio telemetry units which may be used as repeaters, provision of outputs, or as network master unit to connect to PLC or PC
User Configuration		Configuration Software
<b>Diagnostics</b>		
On board diagnostics	Automatic check on startup	Microprocessor operation OK
Diagnostics included in configuration software		Input status, test transmission signal

## 7 WARRANTY

We are pleased that you have purchased this product.

ELPRO products are warranted to be free from manufacturing defects for a period of 2 years from the effective date of purchase. The effective date of purchase is decided solely by ELPRO Technologies.

This warranty does not extend to:

- failures caused by the operation of the equipment outside the particular product's specification, or
- use of the module not in accordance with this User Manual, or
- abuse, misuse, neglect or damage by external causes, or

repairs, alterations, or modifications undertaken other than by an authorised Service Agent.

ELPRO's liability under this warranty is limited to the replacement or repair of the product. This warranty is in lieu of and exclusive of all other warranties. This warranty does not indemnify the purchaser of products for any consequential claim for damages or loss of operations or profits and ELPRO is not liable for any consequential damages or loss of operations or profits resulting from the use of these products. ELPRO is not liable for damages, losses, costs, injury or harm incurred as a consequence of any representations, warranties or conditions made by ELPRO or its representatives or by any other party, except as expressed solely in this document.

Full product specifications and maintenance instructions are available from your Service Agent, your source of purchase, or from the master distributor in your country upon request and should be noted if you are in any doubt about the operating environment for your equipment purchase

In the unlikely event of your purchase being faulty, your warranty extends to free repair or replacement of the faulty unit, after its receipt at the master distributor in your country. Our warranty does not include transport or insurance charges relating to a warranty claim.

Should you wish to make a warranty claim, or obtain service, please forward the module to the nearest authorised Service Agent along with proof of purchase. For details of authorised Service Agents, contact your sales distributor.