

Loop Powered Transmitter LPDT

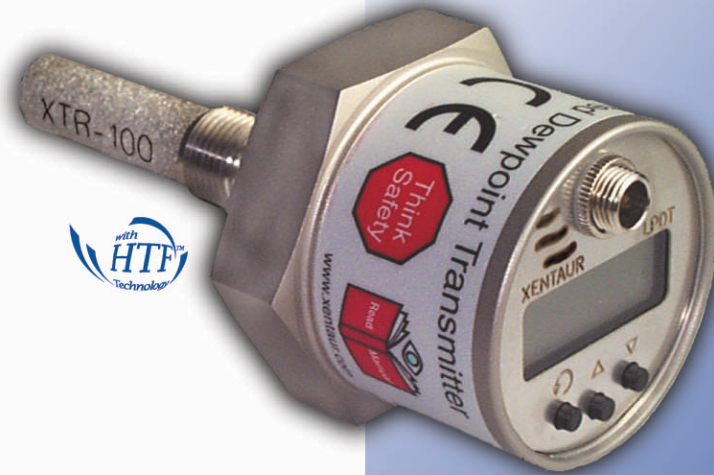

-100°C TO +20°C DEWPOINT



Xentaur's Model LPDT is the world's smallest loop powered (2-wire) dewpoint transmitter with a display. The compact LPDT is a fully functional instrument operated through a miniature custom LCD display and three push buttons, using the same user friendly interface of all Xentaur hygrometers. The analog output is linear to the engineering units selected for display and is user configurable. A weatherproof cap is available for outdoor NEMA 4X (IP65) applications.

METHODS OF USING AND INTERFACING THE LPDT

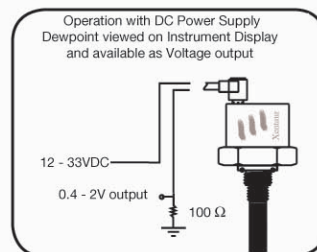
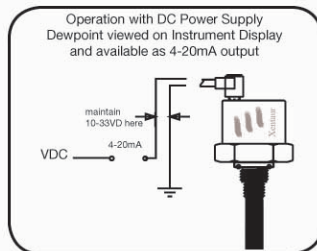
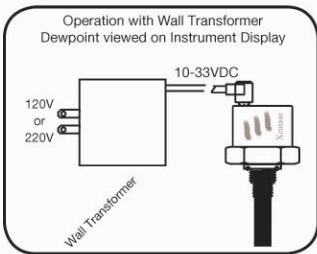

XENTAUR HYPER-THIN-FILM (HTF) Al_2O_3 ™ MOISTURE SENSOR TECHNOLOGY

The model LPDT uses a Xentaur HTF™ Aluminum Oxide sensor. The breakthrough HTF™ sensor technology represents advances in thin film and metal oxide sciences and offers significant performance advantages over all other aluminum oxide sensors.

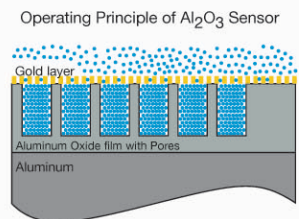

The operating principle of the HTF™ aluminum oxide sensors is that a hygroscopic layer of aluminum oxide adsorbs or releases water molecules within its pores, depending on the water vapor pressure in its environment. The electrical capacitance of the aluminum oxide layer changes with the surrounding water vapor pressure. The electrical capacitance is measured between the aluminum core of the sensor and a porous conductive gold layer on the outside.

The advantages of the HTF sensor technology are a result of the proprietary manufacturing method in which the aluminum oxide layer is made to be hyper thin as well as extremely hygroscopic. This results in a very sensitive sensor with fast response.

HIGH CAPACITANCE RESPONSE

HTF sensors have a capacitance change, several orders of magnitude larger than that of conventional aluminum oxide sensors due to the hyper thin film, a sharp transition layer and a special pore geometry. Additionally, this change is quasi linear and its sensitivity to temperature is negligible. The advantages of a linear high capacitance response are: better sensitivity, better repeatability and faster response times. Also, the measurement system is less prone to noise and drift, and signal conditioning is kept to a minimum.

Hyper Thin Film vs. Conventional Al_2O_3 Sensor
Change of Capacitance with Dewpoint

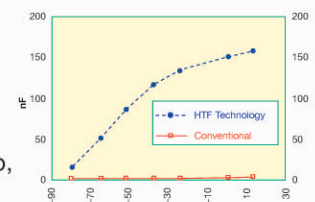

TECHNICAL SPECIFICATIONS

Dewpoint Sensor Element

Type: Hyper-Thin-Film high capacitance Al_2O_3

Dewpoint Range

XTR-100 -100°C to +20°C
(-148°F to +68°F)

XTR-65 -65°C to +20°C
(-85°F to +68°F)

Capacitance 15nF to 200nF

Accuracy ±3°C (± 5.5°F)

Repeatability ±0.5°C (±0.9°F)

Temperature range -10°C to +70°C
(+14°F to +158°F)

Sample Flow Range

(linear vel. @ 1 atm.) ... Static to 100 m/s

Storage Temperature -40°C to +80°C
(-40°F to +176°F)

Calibration Method Field span check

NIST/NPL traceable
multipoint calibration

Output Analog 4-20mA

Alarms The 4-20 mA of the digital output may be used by an external device to operate relays

Isolation Sensor and case are isolated from the current loop and shunted with 33V transorbs

Mechanical

Enclosure Stainless steel
(Weather proof cover optionally available)

Pressure operating range .. Standard: 34bar (500PSI)
Optional: 340 bar (5,000 PSI)

Electrical connections 2.1 mm power jack with retainer
thread size 3/4"-16, 14mm x 12.5mm

Cable Two conductor cable

Power Requirements 10 to 33 VDC, the instrument draws 4-20mA depending on measurement dewpoint

Warranty 1 year

Temperature Measurement

The instrument measures the sample temperature with a precision integrated circuit sensor.

Electronics

Input resolution 0.1°C(dp)

Indicators 3.5 digit LCD with custom legends

Engineering units °C, °F, ppmv, LBS H₂O/mm scf,
gm H₂O/M3

Controls 3 push buttons, all settings stored in EPROM

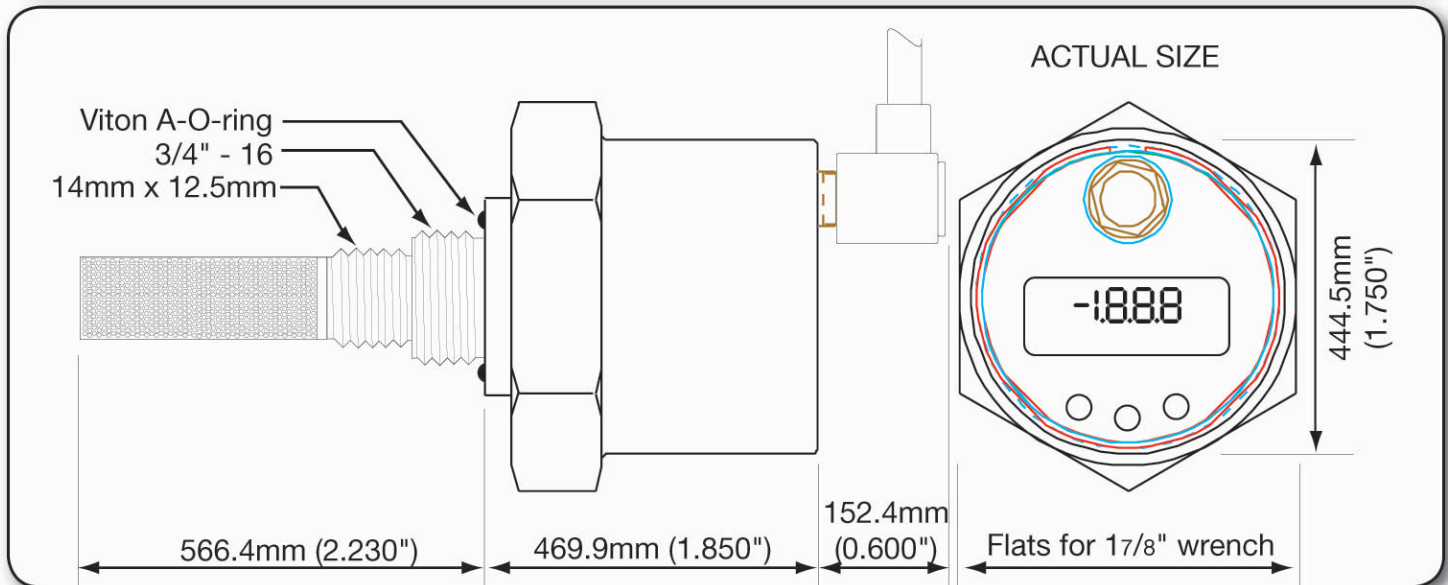

Zone Acticentre - Bâtiment H - 156/220

Rue des Famards - CRT2 - CS 10210 - 59273 FRETIN

Tél. 03 20 62 06 80 Télécopie : 03 20 96 95 62

E-mail : contact@dimelco.com